



Automatic Cyanoacrylate Fuming Chamber

- Safely Obtain Quality Latent Prints and Reproducible Results



Safe FUME™ CA30S



Product

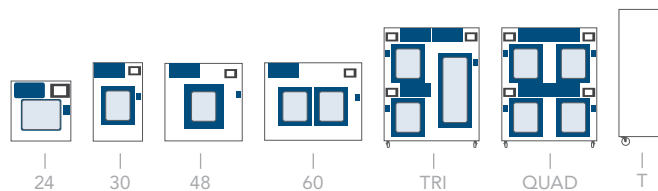

Schedule
Contract # GS-07F5832P



CONTENTS:

- Product Overview (p.2)
- Design Features (p.3)
- Performance & Selection (p.4)
- Filtration Technology (p.5)
- Specifications (p.6)
- Options & Accessories (p.9)

INTRODUCTION

Safe FUME™ Automatic Cyanoacrylate Fuming Chambers are designed to safely develop latent fingerprints using ethyl cyanoacrylate (CNA) vapor in a controlled environment for optimum effectiveness and safety where moisture and fuming time are critical factors. The tamper resistant compartment helps maintain the chain of custody. The unique Air Science® [Multiplex™ Filtration System](#), together with professional design and unique construction features offer personnel protection during use.

The ductless filtration system requires no connection to an outside exhaust system. The automatic control system programs the fuming cycle. A versatile system of hanging rods and shelves allows proper positioning of items of evidence in the chamber.

APPLICATIONS

Using innovative filtration technology, the Safe FUME cyanoacrylate fuming chamber creates a safe work environment over the widest range of applications in the industry.

State and Federal Crime Laboratories \ Crime Scene Investigation \ Law Enforcement Agencies \ Medical Examiners' Programs \ Criminal Justice Education

KEY FEATURES

- Choose from multiple sizes, from bench top to floor standing.
- Multi-chamber cabinets available.
- Caster wheels standard on all models except bench top series.
- Optional UV Lamp decontamination.
- Optional side and rear windows for 360° view of development.

DUCTLESS TECHNOLOGY

The Eco-Friendly Choice

Advanced carbon filtration technology offers a safe, high performance alternative to conventional ducted cabinets for a broad range of applications.

Environmental Benefits. Air Science Safe FUME cyanoacrylate fuming chambers isolate and trap chemical vapors to prevent ecological impact through release into the environment.

Versatile. Each filtration system is selected for its specific application. Carbon filters are available in more than 14 configurations for use with vapors of organic solvents, acids, mercury and formaldehyde. Optional HEPA/ULPA filters can be added for biological safety.

Easy to Install. The cyanoacrylate fuming chamber is self-contained and does not require venting to the outside. Many units are portable and may be moved with minimal downtime and without filter changes. Set-up, operation and filter maintenance are straightforward.

Energy Efficient. Because filtered air is returned to the room, no demands are required of the facility HVAC capacity for make-up air.

Cost Effective. Facility ductwork, HVAC and construction costs are eliminated.

Safe to Use. Cabinet airflow and face velocity protect users from incidental exposures to fumes.

Self-Testing. (select models) Electronic airflow monitoring assures continuous safety. An electronic gas sensor monitors carbon filter performance.



Safe FUME CA30S and CA60T. CA30S shown with optional UV lamp.



Deep into its second generation, Air Science embraces the diversity and cultural heritage of the founders and co-workers who are continuing a tradition of excellence. Demonstrating a commitment to adaptation, inclusion and quality output from a United States-based company with a domestic and global reach.

CONTENTS:

- Product Overview (p.2)
- Design Features (p.3)
- Performance & Selection (p.4)
- Filtration Technology (p.5)
- Specifications (p.6)
- Options & Accessories (p.9)



Safe FUME CA30T, shown open.

DESIGN FEATURES

- A. Filter I.D. Window:** A strategically placed front cover window shows the installed filter part number and installation date for convenience and to encourage timely filter replacement.
- B. Filter Door Key:** Filter access keys prevent unauthorized removal or accidental exposure to dirty filters.
- C. Track and Wheel System:** An efficient filter clamping mechanism allows removal of main filter(s) directly to disposal bag with track and wheel system.
- D. Electrostatic Pre-Filter:** The 99.5% effective electrostatic pre-filter protects and extends the life of the main filter and can be changed without tools while unit is running to prevent operator exposure to captured contaminants.
- E. Dynamic Filtration Chamber:** The dynamic filter chamber prevents leakage of contaminated air by maintaining partial vacuum in the filter plenum.
- F. Control Panel:** The microprocessor control panel manages the Printbuster™ Pro operating sequence with control, oversight and display of all processing functions. The LCD display works with a touchpad data entry keypad to establish all operating parameters.
- G. Doors:** Tempered glass, keyed doors with aluminum frame and tamper proof seal provide improved security, stability and ease of cleaning. Scratch-resistant glass for lasting optimum visibility.
- H. Shelving:** Standard height units include one shelf in a fixed position. Extra tall units include one shelf that is repositionable to fit two configurations.
- I. Fan:** High velocity sparkless and brushless centrifugal fan.
- J. Lighting:** Vapor-proof fluorescent light.

- K. Hanging Rods:** Removable and adjustable stainless steel hanging rod for proper orientation of evidence.
- L. Cool Mist Water Nebulizer/Humidifier:** Programmable to achieve preset humidity conditions quickly and accurately using a replaceable "wicking" filter to eliminate excess cyanoacrylate from building up on the unit.
- M. Hot Plate Accelerator:** Hot plate to polymerize ethyl cyanoacrylate. Air Science also offers optional adjustable temperature hot plates to accommodate a variety of fuming techniques, including MicroBurst™ and typical Super Glue® methods. Hot plates are available with basic knob controls as well as advanced microprocessor controls with LED display.

ADDITIONAL FEATURES

Construction: Models are available in either polypropylene and epoxy coated steel or aluminum frame with plastic wall construction. Doors are tempered glass locking doors with tamper-proof seal and aluminum frame. See selection chart for specifications and dimensions. Available in 110V, 60Hz single phase electrical supply (other voltages available on request).

Optional UV Lamp: Activated ultraviolet light creates light emission conditions known to permit disinfection of the interior between cases to prevent cross-contamination, ensuring integrity of the samples for DNA testing.

Internal Chamber Cleansing: The Internal Chamber Cleansing feature automatically activates to eliminate contamination and remove the harmful vapor from the unit. This process is especially important if the unit is used infrequently or only during certain periods of high evidence volume.

CONTENTS:

- Product Overview (p.2)
- Design Features (p.3)
- Performance & Selection (p.4)
- Filtration Technology (p.5)
- Specifications (p.6)
- Options & Accessories (p.9)

SafeFUME™

Fuming Chamber

24 • 30 • 48 • 60 • TRI • QUAD

PERFORMANCE & SELECTION

4

Each Air Science Safe FUME cyanoacrylate fuming chamber includes features expressed through sound design and certified quality construction. Options and accessories add functional performance to meet specific applications.

PERFORMANCE

The Air Science **Multiplex Filter** offers a range of options for high performance protection. The filter configuration permits a customized combination of filter media for a broad range of chemical families and biological agents if required.

DESIGN

Professional quality Safe FUME cyanoacrylate fuming chambers comply with current technical and safety regulations. The cabinet frame and work surfaces, comprised of industrial components, are durable and chemically resistant.

The Air Science filter assembly is easy to access and easy to change, plus a unique filter clamping design eliminates bypass leakage outside the cabinet.



Through our partner company **Filtco Filters**, Air Science is a single source supplier of all pre-filters, carbon filters, and HEPA/ULPA filters used in our products.

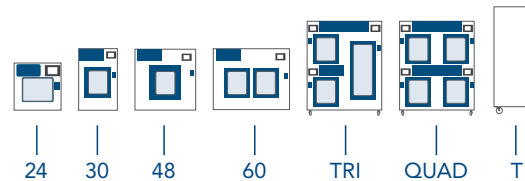

SELECTION

Safe FUME cyanoacrylate fuming chambers are available in 5 specific sizes and multiple configurations, totaling 20 standard models.

CONTROL

Air Science Printbuster Pro LCD Interface Technology

Printbuster Pro is the industry's first use of touchscreen technology offering a simple, easy-to-use solution delivering repeatable results every time. The automatic latent fingerprint development cycle manages the following:

- Relative humidity setpoint. Relative humidity is established via a water-filled nebulizer/humidifier.
- Cabinet temperature display.
- Door status with lock alarm.
- Circulation fan On/Off.
- Hot plate On/Off. The hot plate accelerator polymerizes ethyl cyanoacrylate for a specific time interval.
- Processing time.

- Purge cycle time. Fumes are removed from the chamber through the Multiplex Filtration System via a carbon filter; air is safely exhausted to the room.
- Emergency stop.
- Filter life tracker shows total number of cycles run and alerts operator once filter has reached the maximum recommended number of cycles.

RELIABILITY

Internal systems are isolated from fumes, extending product life.



CONTENTS:

- Product Overview (p.2)
- Design Features (p.3)
- Performance & Selection (p.4)
- Filtration Technology (p.5)**
- Specifications (p.6)
- Options & Accessories (p.9)



FILTRATION

At the heart of the cyanoacrylate fuming chamber is innovative filtration technology. **The Multiplex Filtration System** consists of a pre-filter, main activated carbon or optional HEPA/ULPA filter and safety activated carbon or optional HEPA/ULPA filter. The system permits a customized combination of filter media and configuration for chemical and physical adsorption specific to each application need.

The Air Science **carbon filtration technique** is based on enhanced, activated carbon particle formulations from specially selected, naturally occurring raw material that is superior to wood or other organic sources. The carbon is treated to attain the proper porosity and aggregate surface area and to react with several ranges of aerosolized chemicals moved through the filter by an air handling blower.

View available filters and descriptions on [page 8](#).



SECUR.
safe disposal service

Filter disposal services are available in selected markets providing responsible destruction or recycling of saturated filters in authorized facilities.

FILTER CONFIGURATION

The Multiplex feature permits one or more filtration options to be combined to meet a wider range of multiple-use applications.

The Safe FUME can be equipped with a single activated carbon main filter or with a stacked configuration which combines two main filters, each activated to adsorb one or more specific vapors or family of vapors. For safety against particulates, an optional HEPA or ULPA can also be added.

The carbon filter is sized to fit the specified product model number and configured to optimize airflow across 100% of the filter surface area. The self-contained assembly maximizes filter efficiency, prolongs filter life, optimizes diffusion and saturation and improves user safety.

- P. Electrostatic Pre-Filter:** Protects the main filters from aerosols, mists, dust and particulates.
- C. Activated Carbon Main Filter:** A single, blended or stacked filter configuration.
- H. Primary HEPA/ULPA Filter, Optional:** Both HEPA and ULPA filters use micro-glass fiber media designed to capture fine particles and biologicals. Both filters can capture particles smaller than the micron size for which they are tested. HEPA and ULPA filter efficiencies are 99.97% at 0.3 microns and 99.999% at 0.12 microns respectively.

MULTIPLEX FILTRATION SYSTEM SUMMARY

Application	Chemical	Chemical & Powder
Primary Filter	C	H C
Pre-Filter	P	P

The system can be configured for the capture of acids, bases and particulates, such as biological aerosols, when paired with HEPA or ULPA filters.

AIRFLOW

The Safe FUME fuming chamber maintains a constant face velocity, creating uniform conditions within the chamber. Contaminated air is pulled through the Multiplex Filtration System; clean air is returned to the room.

The main filters are easy to replace and install. The filter clamps tightly against the filter gasket to prevent filter bypass and maintain filter integrity.

⚠ The pre-filter may be replaced while unit is in operation.

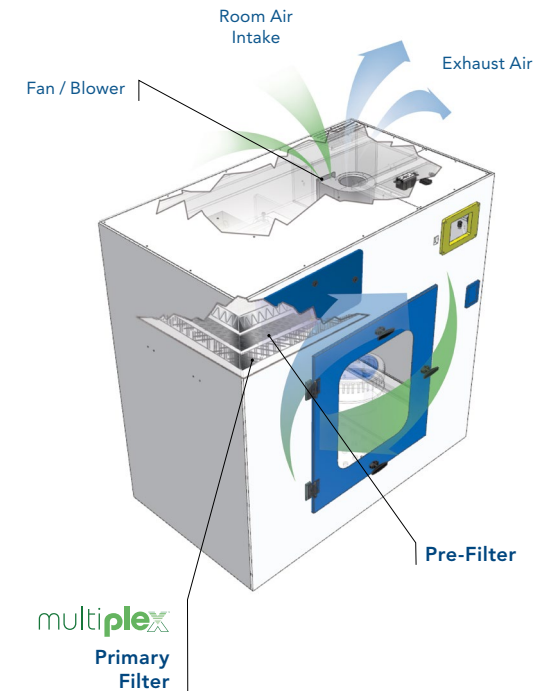

CONTENTS:

- Product Overview (p.2)
- Design Features (p.3)
- Performance & Selection (p.4)
- Filtration Technology (p.5)
- Specifications (p.6)
- Options & Accessories (p.9)

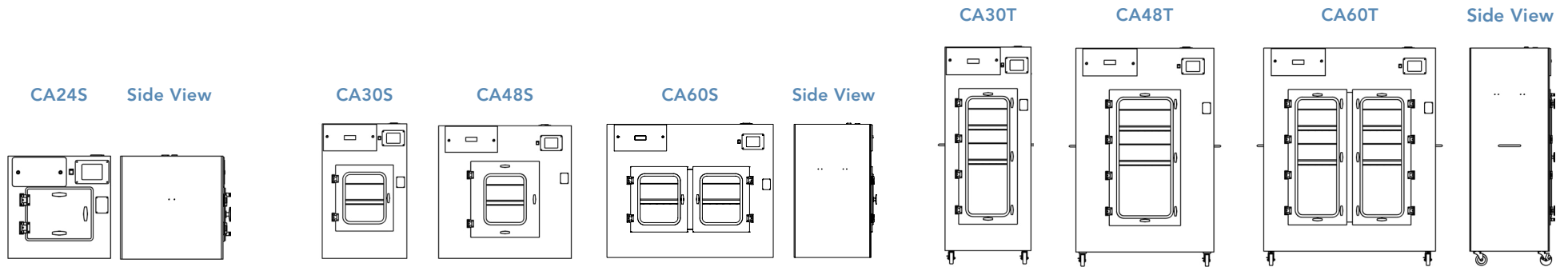

MODEL	DIMENSIONS			WEIGHT (LBS/KG)	
	Internal Height	External (W x D x H)	Shipping (W x D x H)	Net	Ship
Benchtop Models					
CA24S	12.8" / 325 mm	24" x 17.4" x 24" / 610 x 441 x 610 mm	40" x 40" x 55" / 1016 x 1016 x 1397 mm	156 / 71	200 / 91
CA30S	36" / 914 mm	30" x 28" x 48.1" / 762 x 711 x 1220 mm	40" x 40" x 55" / 1016 x 1016 x 1397 mm	175 / 79	215 / 98
CA48S	36" / 914 mm	48" x 28" x 48.1" / 1219 x 711 x 1220 mm	58" x 40" x 55" / 1473 x 1016 x 1397 mm	306 / 139	346 / 157
CA60S	36" / 914 mm	60" x 28" x 48.1" / 1524 x 711 x 1220 mm	65" x 40" x 55" / 1651 x 1016 x 1397 mm	369 / 167	407 / 185
Tall Models					
CA30T	57.2" / 1454 mm	30" x 28" x 74.9" / 762 x 711 x 1902 mm	40" x 40" x 91" / 1016 x 1016 x 2311 mm	271 / 123	316 / 143
CA48T	57.2" / 1454 mm	48" x 28" x 74.9" / 1219 x 711 x 1902 mm	58" x 40" x 91" / 1473 x 1016 x 2311 mm	327 / 148	367 / 166
CA60T	57.2" / 1454 mm	60" x 28" x 74.9" / 1524 x 711 x 1902 mm	70" x 40" x 91" / 1778 x 1016 x 2311 mm	382 / 173	447 / 203

CONTENTS:

- Product Overview (p.2)
- Design Features (p.3)
- Performance & Selection (p.4)
- Filtration Technology (p.5)
- Specifications (p.6)
- Options & Accessories (p.9)

CATRI

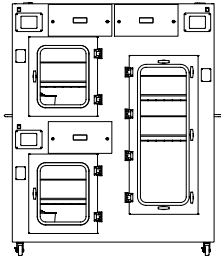

CAQUAD

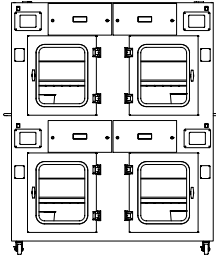

Side View

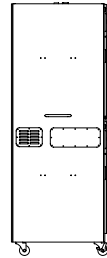

MODEL	DIMENSIONS			WEIGHT (LBS/KG)	
	Internal Height	External (W x D x H)	Shipping (W x D x H)	Net	Ship
Standard Triplex Model*					
Three-chamber floor model includes three individual compartments with independent controls and ductless carbon filters.					
CATRI	2 @ 24" / 610 mm	1 @ 57.2" / 1454 mm	60" x 27.75" x 75" / 1524 x 705 x 1905 mm	70" x 40" x 91" / 1778 x 1016 x 2311 mm	402 / 182 467 / 212
Standard Quad Model*					
Four-chamber floor model includes four individual compartments with independent controls and ductless carbon filters.					
CAQUAD	4 @ 24" / 610 mm	60" x 27.75" x 75" / 1524 x 705 x 1905 mm	70" x 40" x 91" / 1778 x 1016 x 2311 mm	418 / 189 476 / 216	

* Specifications are subject to change without notice.

CONTENTS:

- Product Overview (p.2)
- Design Features (p.3)
- Performance & Selection (p.4)
- Filtration Technology (p.5)
- Specifications (p.6)
- Options & Accessories (p.9)

PRODUCT SPECIFICATIONS

	CA24S CA30S CA48S CA60S	CA30T CA48T CA60T	CATRI	CAQUAD
Filtration				
Airflow	145 cfm	145 cfm	145 cfm	145 cfm
Construction				
Finish	<... White polypropylene and epoxy coated steel. ...>			
Blower	<... Centrifugal blower. ...>			
Controls	<... Main On/Off. ...>			
Monitoring	<... Complete full monitoring of all functions. ...>			
Shelving	Single, fixed position.	Single, two position.	<... Single, per compartment. ...>	
Efficiency				
Lighting	<... (2) 15 watts. ...>			

FILTER SPECIFICATIONS

Safe FUME Model	CA24S CA30S CA48S CA60S	CA30T CA48T CA60T	CATRI	CAQUAD
Primary Filter(s)*	(1)	(1)	(3)	(4)
Pre-Filter*	(1)	(1)	(3)	(4)

* For specific examples refer to Multiplex Filtration System summary on [page 5](#).

FILTER SUMMARY*

Formula	Description
GP Plus!	The most widely used filter in the range, primarily for solvent, organic and alcohol removal.
HEPA/UPLA	Powders and particulates.

*Other formulas may be available.

CONTENTS:

- Product Overview (p.2)
- Design Features (p.3)
- Performance & Selection (p.4)
- Filtration Technology (p.5)
- Specifications (p.6)
- Options & Accessories (p.9)

OPTIONS & ACCESSORIES

Safe FUME Model		CA24S	CA30S	CA48S	CA60S	CA30T CA48T CA60T	CATRI	CAQUAD
Heavy Duty Base Stand	Provides a lower storage half shelf; accommodates wheelchair access. Locking casters fix the chamber in place. 34" tall.	CART-25	CART-30	CART-50	CART-60	--	--	--
Advanced Hot Plate	Advanced hot plates heat up to 400°C and offer microprocessor controls and LED display with enhanced safety features. Low profile design has a maximum capacity of 600 mL. All aluminum construction. Available in 110V or 230V configurations.	AHOTPLATE110 or AHOTPLATE230	AHOTPLATE110 or AHOTPLATE230	AHOTPLATE110 or AHOTPLATE230	AHOTPLATE110 or AHOTPLATE230	AHOTPLATE110 or AHOTPLATE230	AHOTPLATE110 or AHOTPLATE230	AHOTPLATE110 or AHOTPLATE230
UV Lamp*	Creates light emission conditions known to permit decontamination of interior surfaces. Includes a timer, door microswitch, fully closing front sash and UV filtering clear polycarbonate panels. The UV operation must comply with local codes and facility safety practices.	UV-CA	UV-CA	UV-CA	UV-CA	UV-CA	UV-CA	UV-CA

*Includes timer and door microswitch. Safety precautions must be followed.

CONTENTS:

- Product Overview (p.2)
- Design Features (p.3)
- Performance & Selection (p.4)
- Filtration Technology (p.5)
- Specifications (p.6)
- Options & Accessories (p.9)

WARRANTY

This product is protected by the Air Science Legacy Limited Lifetime Warranty™.



For details visit the [Warranty section](#) of our website.

STANDARDS AND COMPLIANCE

Quality Management Systems	ISO 9001:2015
OSHA, Occupational Safety and Health Administration	OSHA Standard -29 CFR, Safety and Health Regulations for General Industry, 1910.1450: Occupational exposure to hazardous chemicals in laboratories. Part B, definition, laboratory type hood. This product may assist you with compliance or as part of your chemical hygiene plan. Please consult your Safety Officer and/or Industrial Hygienist.
Environment	ISO 14001:2015 ENERGY STAR® Partner



The information contained in this manual and the accompanying product are copyrighted and all rights are reserved by Air Science. Air Science reserves the right to make periodic minor design changes without obligation to notify any person or entity of such change.



Schedule
Contract # GS-07F5832P





WolfLabs

Pricing on any accessories shown can be found by keying the part number into the search box on our website.

The specifications listed in this brochure are subject to change by the manufacturer and therefore cannot be guaranteed to be correct. If there are aspects of the specification that must be guaranteed, please provide these to our sales team so that details can be confirmed.

www.wolflabs.co.uk

Tel : 01759 301142

Fax : 01759 301143

sales@wolflabs.co.uk

Please contact us if this literature doesn't answer all your questions.