

BA-T SERIES

Analytical Balance

INSTRUCTION MANUAL

BA-6TE

BA-6DTE

BA-225TE

BA-225DTE

BA-125DTE



A&D Company, Ltd.

© 2021 A&D Company Ltd. All rights reserved.

No part of this publication may be reproduced, transmitted, transcribed, or translated into any language in any form by any means without the written permission of A&D Company Ltd.

The contents of this manual and the specifications of the instrument covered by this manual are subject to change for improvement without notice.

Windows, Word and Excel are trademarks of the Microsoft Corporation., registered in the U.S. and other countries and regions.

The Bluetooth® word mark and logos are registered trademarks owned by Bluetooth SIG, Inc. and any use of such marks by A&D Company Ltd. is under license.

Mac and macOS are trademarks of Apple Inc., registered in the U.S. and other countries and regions.

Product names and company names mentioned in this manual are trademarks or registered trademarks of their respective companies in Japan or other countries and regions.

Contents

1.	Introduction.....	8
1.1.	Features	8
2.	Part Names, Installation and Precautions.....	9
2.1.	Unpacking	10
2.2.	Assembly and installation	11
2.3.	Installation considerations, preparation and precautions	14
2.3.1.	How to adjust the level of the balance	15
2.4.	Precautions during use for more accurate weighing.....	16
2.5.	Precautions after use	17
2.6.	Caution on the power supply	17
2.7.	Connection terminals of the display unit.....	18
3.	Screens and Operations (Keys and Buttons).....	19
3.1.	Standby screen	19
3.2.	HOME screen (weighing screen).....	19
3.3.	On-screen operation buttons	21
3.4.	Input Screen.....	22
3.4.1.	Numerical value input screen.....	22
3.4.2.	Character input screen	23
3.4.3.	Password input screen.....	24
4.	IR Sensors and Auto Doors	25
4.1.	IR sensors	25
4.2.	Auto doors.....	25
5.	Application.....	27
5.1.	Application settings screen	27
5.1.1.	Unit of measure	28
5.2.	Normal weighing	31
5.2.1.	Basic weighing	31
5.2.2.	Zero-point, tare, and weighing range	32
5.2.3.	Smart range function	33
5.3.	Counting mode (PCS).....	34
5.3.1.	Storing a unit weight [Counting mode setting] screen.....	35
5.3.2.	Counting mode sample input [Sample input mode] screen	36
5.3.3.	ACAI function	37
5.3.4.	Unit weight list	38
5.3.5.	Editing and storing a unit weight [Counting mode setting] screen	39
5.4.	Percent weighing [Percent weighing] screen	40
5.4.1.	Storing the 100% reference mass [Percent mode setting] screen.....	40
5.4.2.	Percent mode sample input [Sample input mode] screen	41
5.5.	Minimum weight alert function	42
5.5.1.	Minimum weight setting.....	43
5.5.2.	Minimum weight input.....	43
5.5.3.	Minimum weight setting for measurement	44
5.5.4.	Minimum weight measurement result	46
5.6.	Formulation function	47
5.6.1.	Selecting a recipe.....	48
5.6.2.	Searching a recipe	49

5.6.3.	Editing a recipe.....	50
5.6.4.	Editing a sample.....	51
5.6.5.	Registering a sample.....	52
5.6.6.	Sample weighing screen.....	53
5.6.7.	Tare weighing screen.....	54
5.6.8.	Measurement results screen.....	55
5.6.9.	Recipe registration example.....	56
5.6.10.	Measurement example.....	58
5.6.11.	Exporting/importing recipes (with the touch panel software version 1.019 or later)	59
5.7.	HPLC function.....	60
5.7.1.	Selecting a recipe.....	61
5.7.2.	Searching a recipe.....	62
5.7.3.	Editing a recipe.....	63
5.7.4.	Editing a sample.....	64
5.7.5.	Registering a sample.....	65
5.7.6.	Sample weighing screen.....	66
5.7.7.	Tare weighing screen.....	67
5.7.8.	Measurement results screen.....	67
5.7.9.	Recipe registration example.....	69
5.7.10.	Measurement example.....	71
5.7.11.	Exporting/importing recipes (with the touch panel software version 1.019 or later)	72
5.8.	Statistical calculation function.....	73
5.8.1.	Statistical calculation results.....	74
5.8.2.	Statistical calculation output example.....	76
5.9.	Capacity indicator.....	77
5.10.	Gross/Net/Tare Function.....	78
5.11.	Warning display.....	79
5.11.1.	Impact shock detection (ISD) function.....	80
6.	Quick Performance Check [Repeatability Measurement] Screen.....	81
7.	Communication device.....	82
7.1.1.	[Communication device] – [USB flash drive] settings.....	82
7.1.2.	[Communication device] - [USB device] settings.....	83
7.1.3.	[Communication device] - [Bluetooth] settings.....	83
8.	Password Function.....	84
8.1.	Log-in screen.....	85
8.2.	User authorization.....	85
8.2.1.	User authorization - Change to settings not allowed.....	86
8.2.2.	User authorization - Date/time setting not allowed.....	88
8.2.3.	User authorization - Ext. sensitivity adjustment not allowed.....	89
8.2.4.	User authorization - Int. sensitivity adjustment not allowed.....	90
8.3.	User management.....	91
8.3.1.	User management for registration.....	92
8.3.2.	User management for edit.....	93
9.	Menu Screen.....	94
10.	[Sensitivity adjustment] screen.....	95
10.1.	Internal sensitivity adjustment.....	96
10.2.	External sensitivity adjustment.....	97
10.2.1.	Procedure for external sensitivity adjustment.....	98

10.3.	Automatic sensitivity adjustment.....	99
10.4.	Sensitivity adjustment setting.....	100
10.5.	Correcting the internal weight value.....	100
11.	Calibration test/check.....	101
11.1.	Daily check.....	102
11.1.1.	Output example for daily check output results	107
11.2.	Periodic check.....	108
11.2.1.	Output example for periodic check output results	117
11.3.	Repeatability check.....	119
11.3.1.	Repeatability measurement with the internal weight.....	119
11.3.2.	Repeatability measurement with an external weight.....	120
11.4.	Internal calibration test.....	121
11.5.	External calibration test.....	122
11.6.	AND-MEET (with the touch panel software version 1.019 or later).....	123
11.6.1.	[AND-MEET weighing] screen	125
11.6.2.	[AND-MEET graph] screen.....	125
11.6.3.	Description of a graph: temperature/zero point change/span	126
11.6.4.	Description of a graph: temperature/repeatability	126
11.6.5.	[AND-MEET result list] screen	127
11.6.6.	[AND-MEET result] screen.....	128
11.6.7.	AND-MEET analysis graph example.....	129
11.7.	Daily/periodic check settings.....	130
11.8.	Daily/periodic check reminder.....	130
11.8.1.	Startup screen when the daily check reminder is set to ON	131
11.8.2.	Startup screen when the periodic check reminder is set to ON	131
11.9.	Standard value setting	132
11.9.1.	Standard value setting: Repeatability.....	132
11.9.2.	Standard value setting: Sensitivity test	133
11.9.3.	Standard value setting: Eccentricity	133
11.10.	Report data	134
12.	Filter Settings	135
12.1.	Commentary on filter settings	136
13.	System settings.....	137
13.1.	Display settings	138
13.2.	IR sensors	139
13.3.	Breeze break auto doors.....	140
13.4.	Date/time setting	141
13.5.	Buzzer	142
13.6.	Communication	143
13.7.	Data Output.....	143
13.8.	Data output mode	144
13.9.	Data to be added.....	145
13.10.	Data Output settings	146
13.11.	Command settings	147
13.12.	GLP output.....	148
13.13.	RS-232C interface	154
13.14.	USB interface	155
13.15.	Wired LAN.....	156

13.16.	Bluetooth	157
13.17.	UFC format.....	158
13.18.	Language	159
13.19.	ID number settings.....	159
13.20.	External input switch	160
13.21.	Initialization	160
13.22.	Balance status.....	161
13.23.	Balance information	161
13.24.	Software version	162
13.25.	History	162
13.26.	Log-in/log-out history	163
13.27.	Operation history.....	164
13.28.	Sensitivity adjustment history.....	165
13.29.	Impact shock detection history.....	166
14.	Underhook	167
15.	Interface Specifications (Standard).....	168
15.1.	RS-232C specifications.....	168
15.2.	USB specifications	169
15.3.	USB flash drive (USB host).....	170
15.4.	External input terminal (external input switch).....	171
15.5.	Wired LAN specifications	172
15.5.1.	Network settings.....	173
16.	Connection with Peripheral Devices	174
16.1.	Cables required to connect to peripheral devices.....	174
16.2.	Data output method	175
16.3.	Examples: Connecting multiple peripheral devices	176
16.3.1.	Printer and personal computer connection	176
17.	Printing Weighing Value Data with a Printer	177
17.1.	For an AD-8127 multi-functional compact printer	177
17.1.1.	Printing only weighing value data.....	177
17.1.2.	Printing weighing value data with the ID number and timestamp using the clock/calendar function of the balance	178
17.1.3.	Printing information other than weighing value data	179
18.	Connecting to a Personal Computer	180
18.1.	Quick USB mode.....	180
18.2.	Virtual COM mode.....	181
18.3.	RS-232C	181
18.4.	LAN	181
18.5.	Bluetooth	181
18.6.	Data communication software.....	182
18.6.1.	WinCT (USB Virtual COM mode or RS-232C)	182
18.6.2.	WinCT-Plus (wired LAN)	182
19.	Data Output	183
19.1.	Data output mode	183
19.1.1.	Key mode	183
19.1.2.	Auto print mode	183
19.1.3.	Stream mode	184
19.1.4.	Interval mode.....	184

19.2.	Weighing data format.....	185
19.2.1.	Output examples of weighing data format.....	189
19.2.2.	Other data formats	191
20.	Command.....	193
20.1.	Control commands.....	193
20.2.	AK code and error codes	196
20.3.	Command usage examples	197
21.	UFC Function	199
21.1.	UFC program commands.....	199
21.1.1.	Examples of UFC program command creation.....	200
22.	Key Lock Function.....	201
22.1.	Locking all key switches.....	201
22.2.	Sensitivity adjustment while the keys are locked.....	202
22.2.1.	Procedure for external sensitivity adjustment while the keys are locked.....	202
23.	Error Codes	203
23.1.	Error code list.....	203
24.	Ionizer.....	206
24.1.	Usage.....	206
24.2.	Optimizing the Ionizer	207
24.3.	Maintaining the ionizer	207
25.	Maintenance.....	208
25.1.	Treatment of the balance	208
26.	Troubleshooting	209
26.1.	Checking the balance performance and environment	209
26.2.	Asking for repair	210
27.	Specifications	211
27.1.	Common specifications	211
27.1.1.	Function.....	211
27.1.2.	Size/Weight	211
27.2.	Individual Specifications.....	212
27.3.	External dimensions.....	213
27.4.	Peripherals	216
28.	Compliance	218
28.1.	Compliance with FCC Rules	218
28.2.	IC.....	218
28.3.	Bluetooth®	218

1. Introduction

Thank you for purchasing A&D's electronic balance.

Please read this instruction manual carefully to understand and make full use of the BA-T series analytical electronic balance.

Caution

Operations may differ depending on the software version of your balance.

For confirmation of the software version of the balance, refer to "13.24. Software version".

1.1. Features

- A 5-inch touch screen is adopted for easy operation.
- Intuitive operation is provided through the touch screen.
- Equipped with the breeze break auto doors that can be opened and closed without touching them.
- The removable breeze break makes it easy to clean the inside of the weighing chamber.
- A self check function is included for automatically evaluating repeatability performance without a weight.
- The BA-T series can automatically perform sensitivity adjustment with the internal weight. (Automatic sensitivity adjustment)
(Temperature change, set time, fixed time interval [interval time])
- When performing the sensitivity adjustment/calibration test, etc. for the balance, the output corresponding to GLP/GMP, etc. can be output.
Using a printer (sold separately), it is possible to record the sensitivity adjustment/calibration test results.
GLP : Good Laboratory Practice. Standards for implementing safety tests for drugs and medicines.
GMP : Good Manufacturing Practice. Rules for manufacturing and quality control.
- The clock built into the balance allows you to output the weighing value with the date and time. (The clock settings can be restricted so that only the Administrator can change them. [Password function])
- The BA-T series comes standard with the underhook for weighing magnetic materials.
- Six different applications are available.
Normal weighing, counting mode, percent weighing, minimum weight alert function, formulation mode, and HPLC mode.
- BA-6DTE, BA-225DTE and BA-125DTE have the smart range function as standard. This function allows for weighing with the precision range after subtracting the tare within the weighing capacity.
The readability of precision range for BA-6DTE is 1 µg.
The readability of precision range for BA-225DTE and BA-125DTE is 10 µg.
- With the password function, the sensitivity adjustment of the balance and the operation of changing the function table can be restricted.
- An RS-232C interface, USB interface, Ethernet and Bluetooth for outputting the weighing value and data of the balance are equipped as standard.
It is possible to communicate with a Windows personal computer that has data communication software WinCT or WinCT-Plus installed. The software can be downloaded from our website (<https://www.aandd.jp>).
- The BA-T series is equipped with a DC type ionizer (static eliminator) that does not generate wind, and eliminates static electricity from charged objects before weighing in order to reduce errors due to static electricity. The discharge electrode unit of the ionizer can be removed and can be cleaned and replaced by itself.

2. Part Names, Installation and Precautions

Caution

- This product is a precision instrument, and it should be carefully unpacked.
It is advisable to store the packing materials so that they can be used when transporting the balance for repair.
- The contents of the package vary depending on the product. Refer to the illustration of the packing contents and make sure that everything is included.
- Do not connect the AC adapter to the balance until the balance is assembled and installed.
- Do not connect the included AC adapter to other devices.
- Use the dedicated AC adapter specified for the balance.
- If you use the wrong AC adapter, the balance and other equipment may not work properly.
- Make sure that the AC adapter is unplugged before you connect the breeze break unit and the ionizer.
- BA-T series analytical balance is composed of the weighing unit and display unit. It is not possible to replace just one of the units.

2.1. Unpacking

Packing contents common to BA-T series

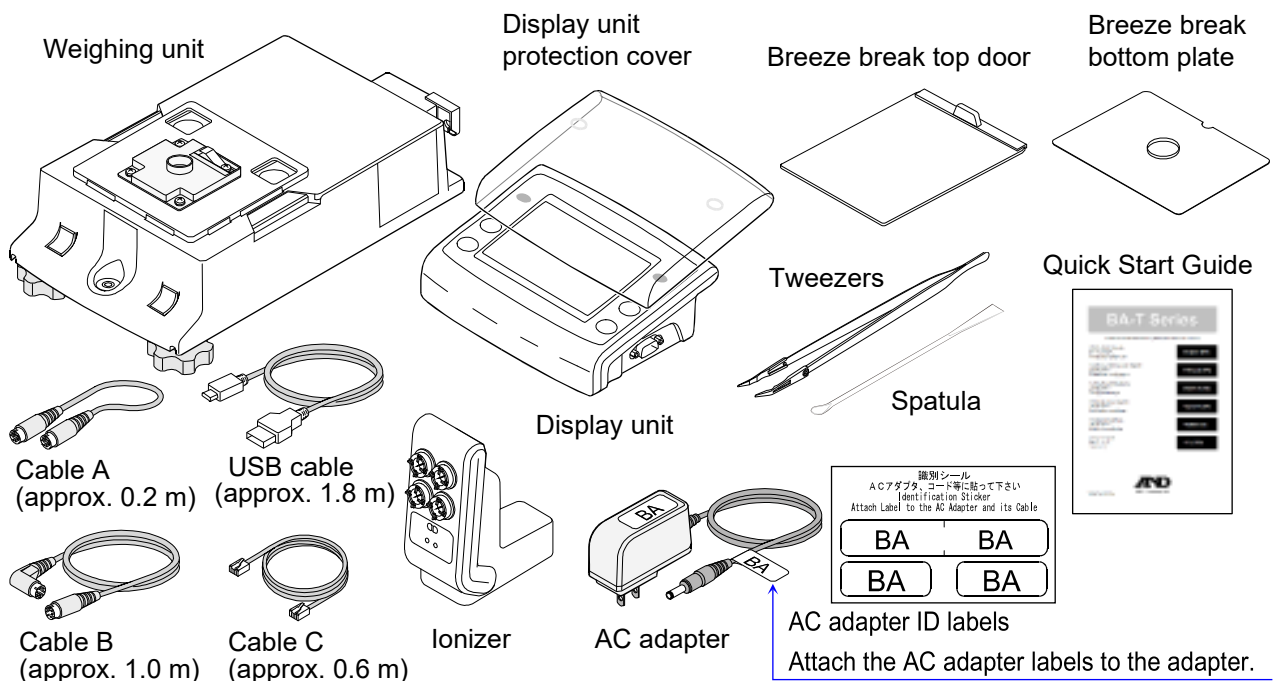

Packing contents for BA-6TE / BA-6DTE

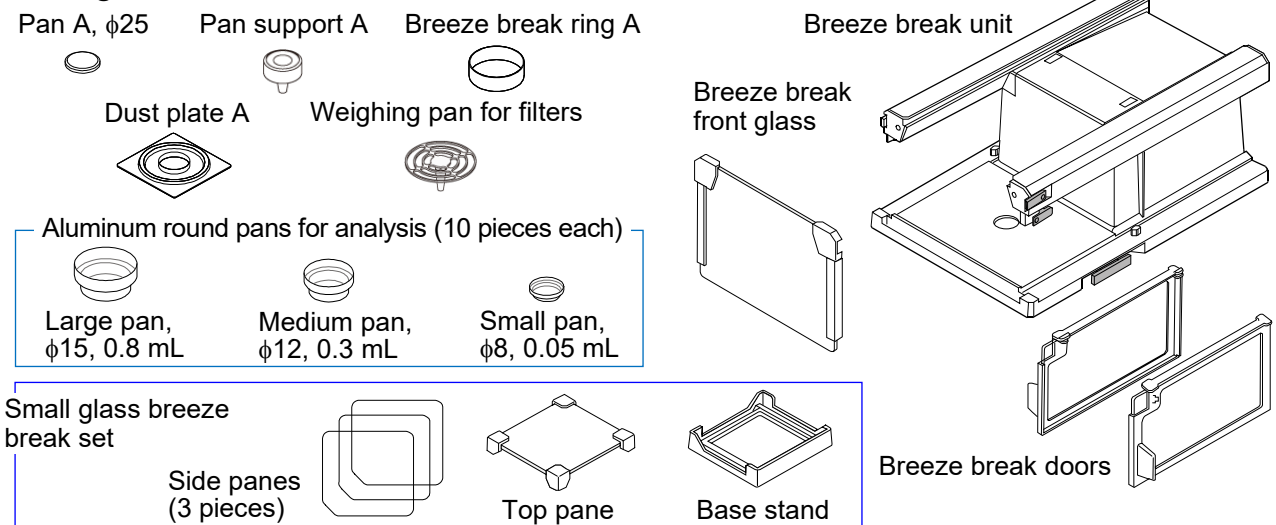

Packing contents for BA-225TE / BA-225DTE / BA-125DTE

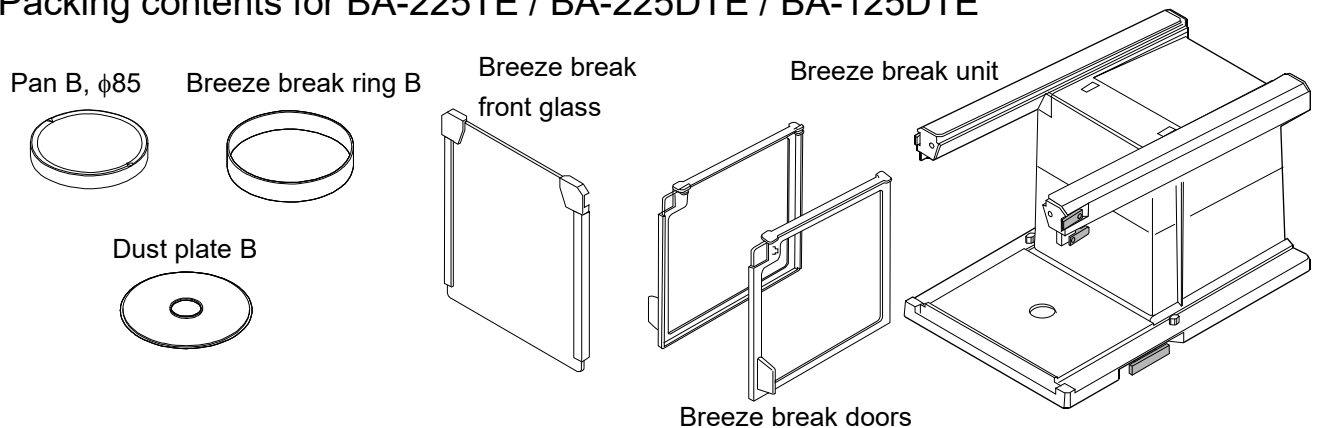

2.2. Assembly and installation

The BA-6TE is used here for the example of assembly. Other models can be assembled in the same way.

- Step 1. Pull out the breeze break locking handles.
- Step 2. Place the breeze break unit on the weighing unit.
- Step 3. Push in the breeze break locking handles to secure the units to each other.

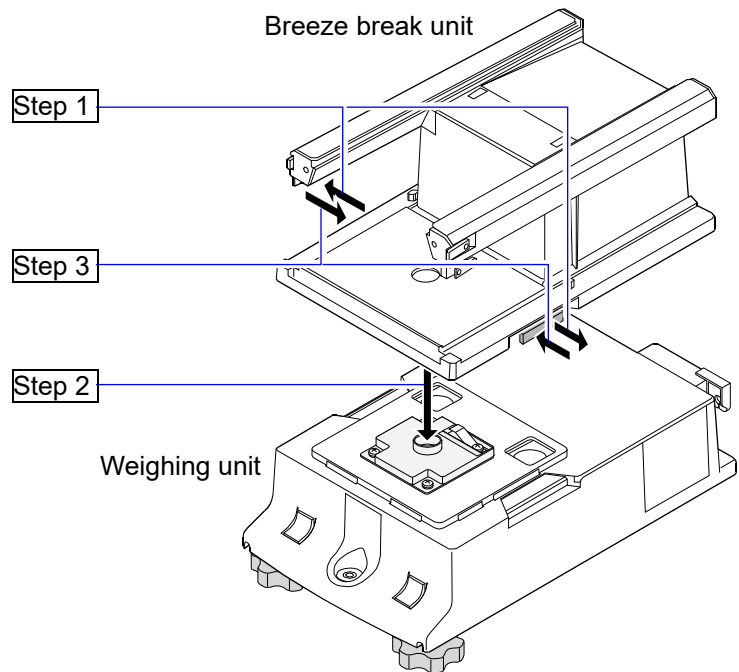

- Step 4. Assemble the weighing pan.
- For BA-6TE / BA-6DTE, assemble the five parts of the weighing pan in the correct position by referring to the cross-sectional view.

In addition to the standard weighing pan (Pan A), you can also use the weighing pan for filters. The weighing pan for filters is approximately 0.2 g heavier than the standard weighing pan (Pan A). Therefore, the weighing capacity when the weighing pan for filters is used will be approximately 6.0 g.

For BA-225TE / BA-225DTE / BA-125DTE, assemble the four parts of the weighing pan in the correct position by referring to the cross-sectional view.

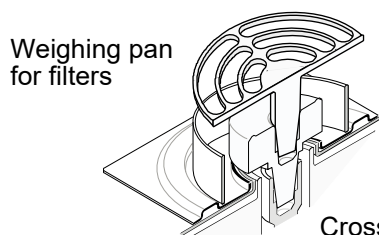
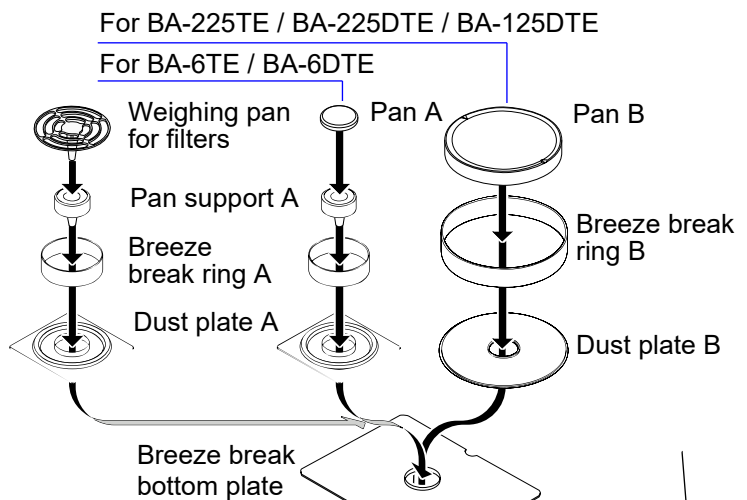

Cross-sectional views
BA-6TE / BA-6DTE

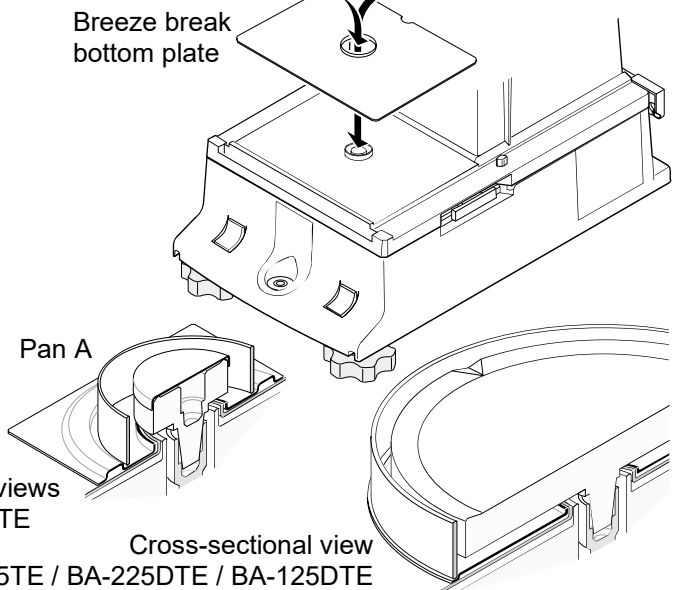

- Step 5. Assemble the glass breeze break.
- Assemble the BA-6TE / BA-6DTE glass breeze break in the weighing chamber.
- Align the side panes with the notch of the base stand.

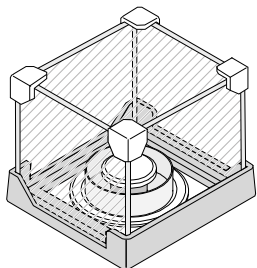

Example of the small breeze break with the right side open.

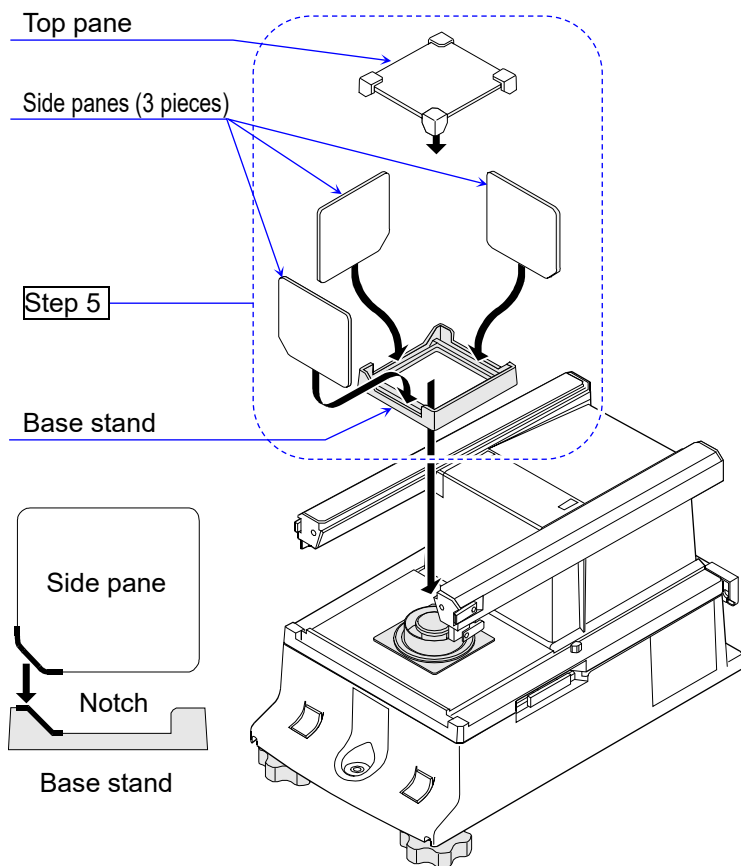

- Step 6. Insert the breeze break top door from the handle side.

- Step 7. Assemble the breeze break doors on the left and right sides.

- 7a Insert the breeze break doors on the left and right sides.
- 7b Secure the breeze break doors with the latches.

- Step 8. Assemble the breeze break front glass.

- 8a Insert the breeze break front glass.
- 8b Secure the breeze break front glass with the latches.

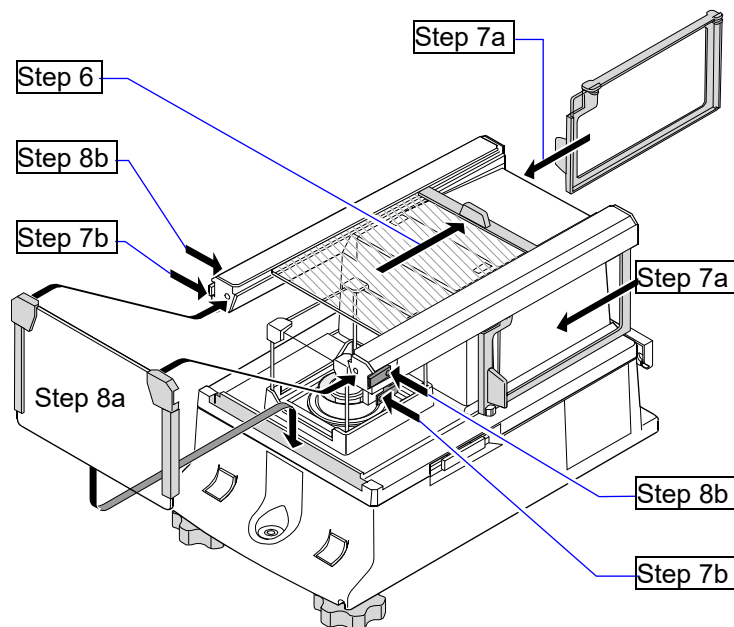

Step 9. Using the included cable A and cable B, connect the "weighing unit" and "breeze break unit" (with the cable A) and the "display unit" and "weighing unit" (with the cable B) respectively, paying attention to the direction of the arrow on each cable (on the connector).

Caution: Make sure to unplug the AC adapter before connecting.

Step 10. If the display unit is placed in front of the weighing unit, cable B can be stowed in the left or right groove of the weighing unit. Loosen the leveling foot when stowing the cable in the groove.

Caution: When stowing the cable, do not tilt the weighing unit.

Step 11. Connect the breeze break unit and ionizer with the included cable C.

Caution: The ionizer operates when the AC adapter is connected to the balance.

Step 12. Connect the included AC adapter to the balance.

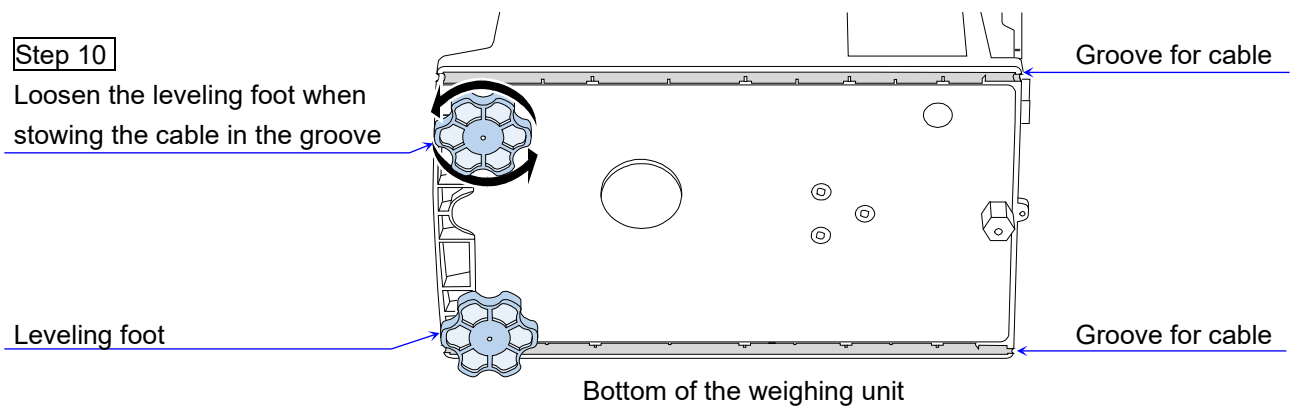
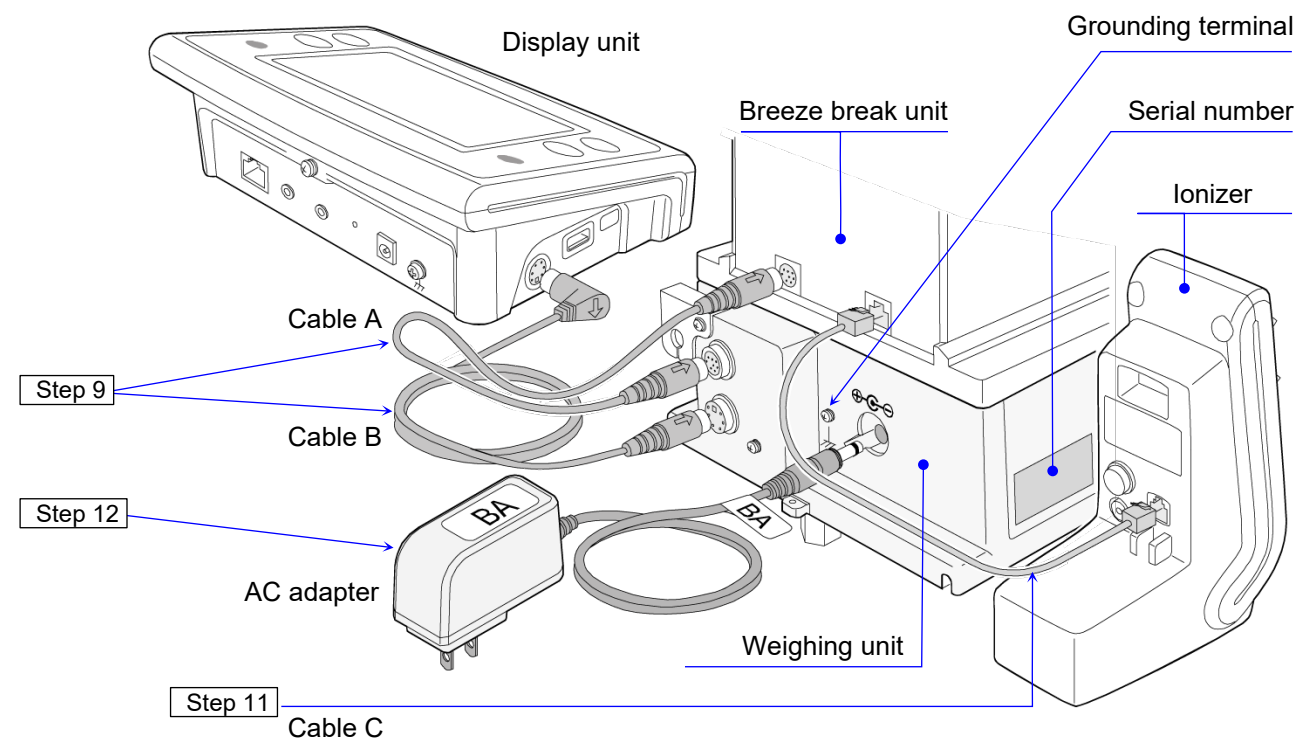

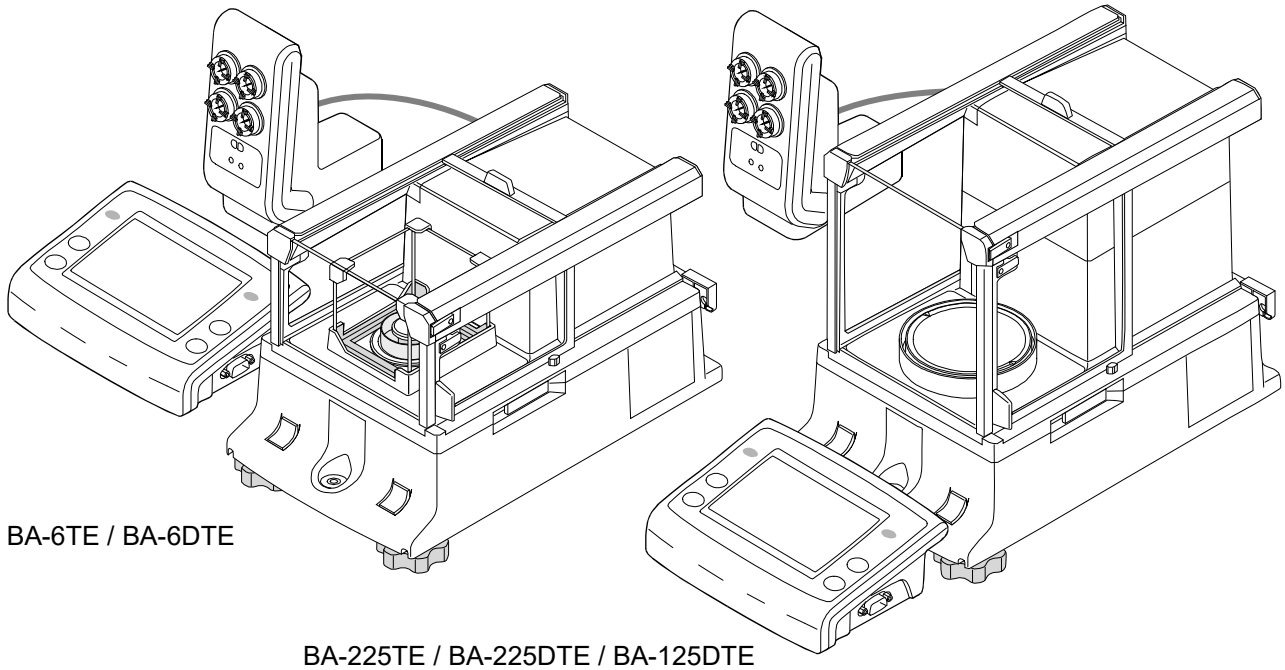

BA-6TE / BA-6DTE

BA-225TE / BA-225DTE / BA-125DTE

2.3. Installation considerations, preparation and precautions

- ❑ Prepare the following installation conditions in order to bring out the full performance of the balance. Note that the installation environment needs to be taken into consideration for the highly sensitive BA-6TE / BA-6DTE.
- ❑ Install the balance in an environment where the temperature and relative humidity are not excessive. The best operating temperature is about $20^{\circ}\text{C} \pm 2^{\circ}\text{C}$ at about 45% to 60% relative humidity.
- ❑ Install the balance where it is free of dust.
- ❑ The weighing table should be solid. (An anti-vibration table or stone table is ideal)
We recommend using an anti-vibration table (AD-1671) for BA-6TE.
It is advisable to install the display unit in a location other than on the anti-vibration table so that errors due to tilt that occurs when operating the switches of the balance on the anti-vibration table can be avoided.
- ❑ Place the balance on a horizontal table, and make sure that it is not tilted.
- ❑ Install the balance in a stable location, avoiding vibration and shock. Corners of rooms on the first floor are best, as they are less prone to vibration.
- ❑ Install the balance where it is not affected by heaters or air conditioners. Avoid breezes and drafts in the room.
You can reduce the influence of breezes and drafts by using an AD-1672/AD-1672A (large size) or AD-1676 (medium size) tabletop breeze break.
- ❑ Install the balance where it is not exposed to direct sunlight.
- ❑ Install the balance away from equipment which produces magnetic fields.
- ❑ Level the weighing unit with the leveling feet and bubble spirit level. Refer to [“2.3.1. How to adjust the level of the balance”](#).

- Be sure to warm up the balance before use for at least an hour, or at least four hours for BA-6TE/BA-6DTE, with the AC adapter connected to the power supply.
- Adjust the sensitivity of the balance before using it for the first time or after having moved it to another location so that accurate weighing can be performed. For how to adjust sensitivity, refer to “10. [Sensitivity Adjustment] Screen”.

⚠ CAUTION Do not install the balance where flammable or corrosive gas is present.

2.3.1. How to adjust the level of the balance

The balance is level (Correct weighing) The balance is tilted (Inaccurate weighing)

Up Leveling foot Down Down Leveling foot Up

Red circle Bubble

Leveling foot

Bubble spirit level

- Level the balance by adjusting the leveling feet so that the bubble of the bubble spirit level is centered in the red circle.

<p>When the bubble is off to the left. Turn the leveling foot on the front right in the clockwise direction.</p>	<p>When the bubble is off to the right. Turn the leveling foot on the front left in the clockwise direction.</p>
<p>When the bubble is off to the backward position. Turn both leveling feet on the front in the clockwise direction at the same time.</p>	<p>When the bubble is off to the forward position. Turn both leveling feet on the front in the counterclockwise direction at the same time.</p>

2.4. Precautions during use for more accurate weighing

For precise and accurate weighing, please take notice of the following.

- Weighing errors may occur due to the influence of static electricity. Note that if the ambient humidity drops below 45% RH insulators such as plastics are liable to have static electricity. Ground the balance and perform the following as needed.
 - A DC type ionizer that produces no currents of air is available for the BA-T series balances. Refer to “24. Ionizer” and remove static electricity from the charged sample directly.
 - Increase the relative humidity at the place where the balance is installed.
 - Weigh the sample in a conductive metal container or the like.
 - Wipe off charged materials such as plastic with a damp cloth to suppress static electricity.
- Influence of magnetism may cause weighing errors. When measuring magnetic materials (iron, etc.), keep the sample away from the balance main body by means such as underhook weighing.
- Place the sample in the center of the weighing pan.
- Weighing errors may occur if there is a difference between the ambient temperature and temperature of the sample (and the container). For example, when the room temperature is 20 °C, convection occurs around a Petri dish or watch glass that is 40 °C and the balance displays a value lighter than the actual weight. Before weighing the sample and the container, try to acclimatize them to the ambient temperature.
- Perform the weighing operation carefully and quickly. If measurement takes a long time, error-inducing factors will increase due to changes in temperature and humidity in the weighing chamber, air turbulence or reaction/humidity absorption by the sample.
- Do not leave the sample on the weighing pan for an extended period of time. If a sample is left on the weighing pan for a long time, the measured value will change due to deviation from the zero point caused by environmental changes or due to creep phenomenon.
- When placing a sample on the weighing pan, do not drop it, or do not place a sample greater than the balance weighing capacity. In addition, place the sample in the center of the pan.
- With the highly sensitive BA-6TE, the weighing value may fluctuate after the stabilization indicator lights up. It is advisable to set a certain reading time (10 seconds, etc.) after the stabilization indicator lights up and read the value.

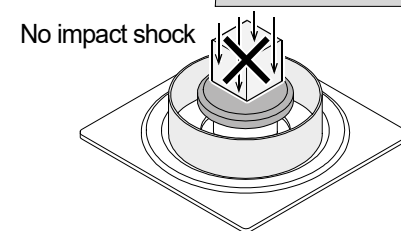
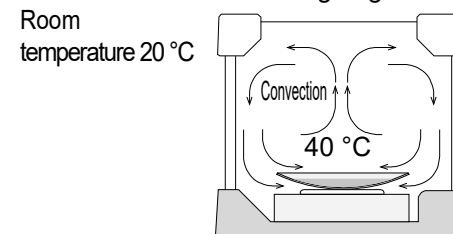
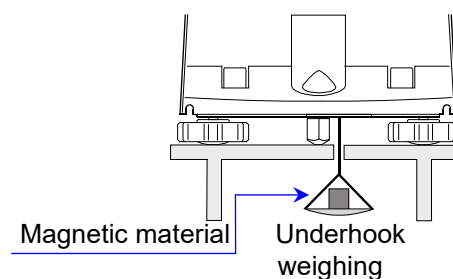
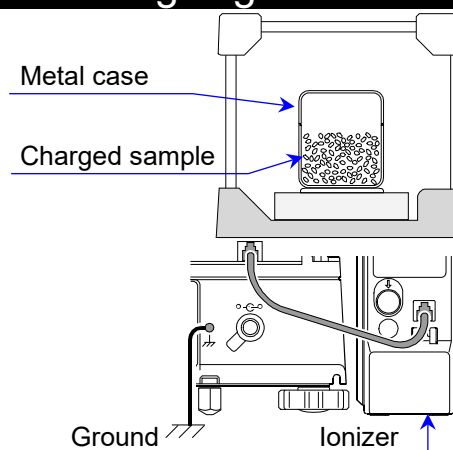

-
- ❑ For weighing where impurities will be a problem, it is advisable to prepare samples outside the weighing chamber in order to prevent the substance from scattering inside the weighing chamber.
 - ❑ When pressing the touch screen or keys, do not press with a sharp object such as a pen. Instead, press the center of the key with your finger.
 - ❑ Be sure to press the **RE-ZERO** button  before weighing in order to eliminate measurement errors.
 - ❑ Measurement results include error from air buoyancy. The buoyancy of air varies depending on the sample volume, atmospheric pressure, temperature, and humidity. Correct the buoyancy for the most precise measurement.
 - ❑ Prevent foreign substances such as powder, liquid, and metal pieces from entering the balance.

2.5. Precautions after use

- ❑ Avoid mechanical shock to the balance.
- ❑ Do not disassemble the balance.
- ❑ Do not use any strong organic solvents to clean the balance. Clean the balance with a lint free cloth that is moistened with a mild detergent.
- ❑ Prevent foreign substances such as powder, liquid and metal pieces from entering the balance.

2.6. Caution on the power supply

- ❑ Be sure to warm up the balance before use for at least an hour, or at least four hours for BA-6TE/BA-6DTE, with the AC adapter connected to the power supply.
- ❑ The balance is constantly provided with power as long as the AC adapter is connected. The balance is not adversely affected in this state. It is advisable to always keep the balance in this state for accurate weighing.
- ❑ Be sure to keep the BA-6TE/BA-6DTE always in a state where power is being supplied.

2.7. Connection terminals of the display unit

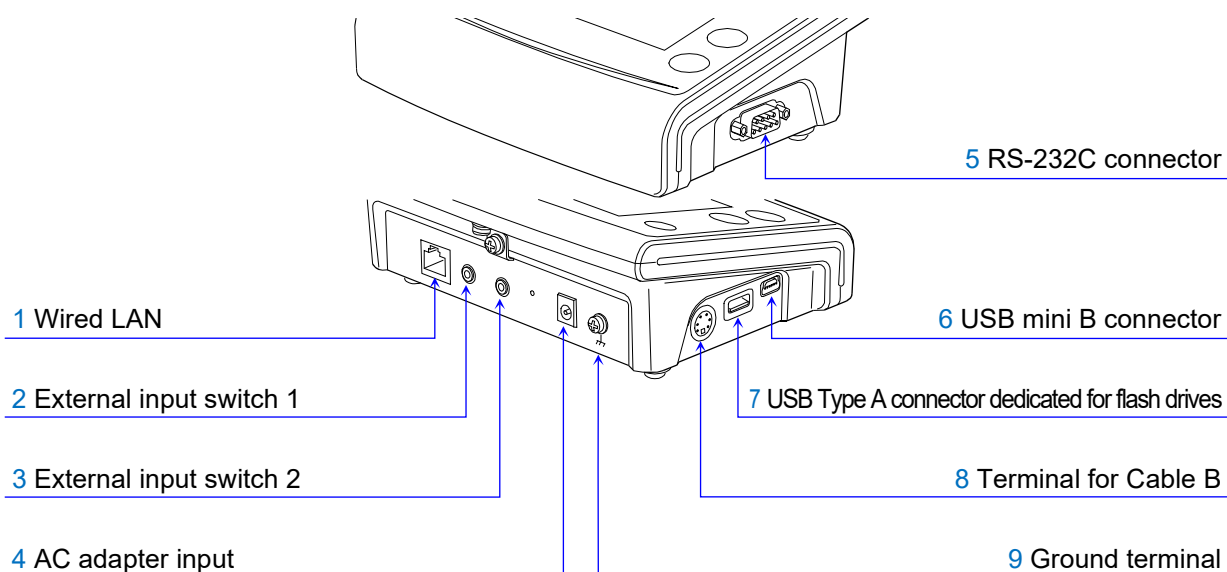

	Name	Description
1	Wired LAN	For configuration details, refer to “13.15. Wired LAN” .
2	External input switch 1	A contact input switch.
3	External input switch 2	For configuration details, refer to “13.20. External input switch” . For usage details, refer to “15.4. External input terminal (external input switch)” .
4	AC adapter input	For precautions for use, refer to “2. Part Names, Installation and Precautions” .
5	RS-232C connector	For configuration details, refer to “13.13. RS-232C interface” . For specifications, refer to “15.1. RS-232C specifications” . For usage details, refer to “16. Connection with Peripheral Devices” .
6	USB mini B connector	For configuration details, refer to “13.14. USB interface” . For specifications, refer to “15.2. USB specifications” . For usage details, refer to “16. Connection with Peripheral Devices” and “18. Connecting to a Personal Computer” .
7	USB Type A connector	Dedicated for USB flash drives. For usage details, refer to “15.3. USB flash drive (USB host)” .
8	Terminal for Cable B	Connected to the weighing unit. Refer to “2.2. Assembly and installation” .
9	Ground terminal	For related items, refer to “2.4. Precautions during use for more accurate weighing” .

3. Screens and Operations (Keys and Buttons)

3.1. Standby screen

- When you touch the **ON:OFF** key  or the touch screen in the standby screen, the weighing screen is displayed.

When you select a key other than the ON:OFF key, the corresponding screen is displayed.



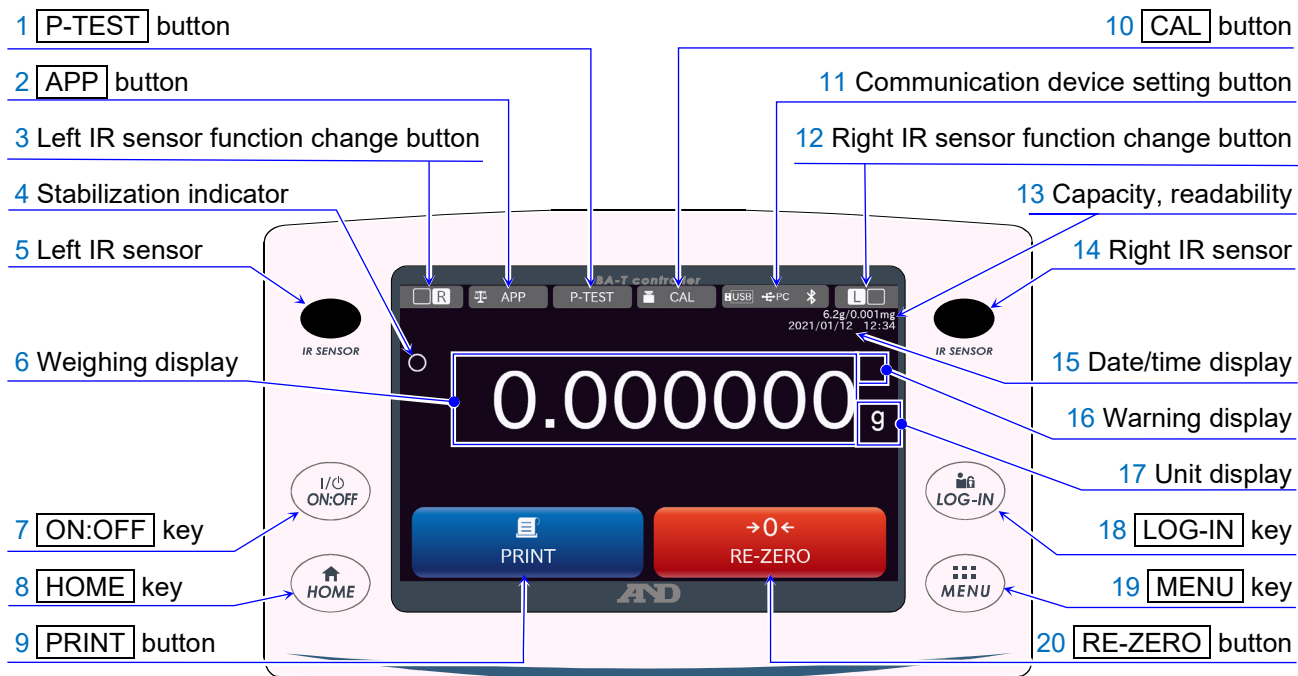

3.2. HOME screen (weighing screen)

- The HOME screen is displayed when you touch the **HOME** key .



1	P-TEST button	The P-TEST button performs a quick performance test. The quick performance test automatically checks the performance of the balance by loading and unloading the internal weight. Refer to " 6. Quick Performance Check ".
2	APP button	The APP button displays the application setting screen and saves the settings related to weighing. Main items: Application selection (Normal weighing, Counting mode, Percent mode, Minimum weight alert function, Unit of measure, Minimum display digit, Statistical calculation function, Decimal separator, Warning display, etc.) Refer to " 5. Application ".
3	Left IR sensor function change button	Displays the options for changing the IR sensor operation settings. You can configure the settings individually for the left and right IR sensors. At the factory setting, they open/close the breeze break door.
4	Stabilization indicator	Displayed when the weighing value of the balance is stable.
5	Left IR sensor	A touchless sensor. When you bring your hand closer, it reacts and the assigned breeze break door opens/closes (at the factory setting). Refer to " 4. IR Sensors and Auto Doors ".
6	Weighing display	Displays the weighing value of the balance.
7	ON:OFF key	Turns the screen display on and off. The ON:OFF key is active during any operation. When the screen display is turned off, the standby screen appears. When the screen display is turned on, the weighing screen appears.
8	HOME key	Displays the weighing screen. The HOME key is active during any operation.
9	PRINT button	Outputs data to the device connected to the balance. Refer to " 16. Connection with Peripheral Devices " and " 19. Data Output ".
10	CAL button	The CAL button displays the [Sensitivity adjustment/calibration test] screen. Select and execute the sensitivity adjustment/calibration test with the internal or external weight. Refer to " 10. [Sensitivity Adjustment] Screen ".
11	Communication device setting button	Displays the [7. Communication device] screen. Configure the settings of or remove the connected communication device.
12	Right IR sensor function change button	Displays the options for changing the IR sensor operation settings. You can configure the settings individually for the left and right IR sensors. At the factory setting, they open/close the breeze break door.
13	Capacity, readability	Displays the capacity and readability of the balance.
14	Right IR sensor	A touchless sensor. When you bring your hand closer, it reacts and the assigned breeze break door opens/closes (at the factory setting). Refer to " 4. IR Sensors and Auto Doors ".
15	Date/time display	Displays the current date and time.
16	Warning display	Refer to the next page.
17	Unit display	Displays the set unit.

18	LOG-IN key	Displays the log-in screen. The LOG-IN key is active at any time, and pressing the LOG-IN key during operation always displays the log-in screen. For details, refer to “8. Password Function”.
19	MENU key	Displays the MENU screen. The MENU key is active during any operation.
20	RE-ZERO button	Sets the displayed value to zero.

	Warning display	Name	Description	Display priority
		Shock indicator	Displayed by the shock detection function.	High
16		Static elimination recommended	Displayed when the relative humidity inside the balance is 45% or less. (Lights up for about 30 seconds after the start of weighing)	Medium
		Door open/close	Displayed when the left/right breeze break door is open.	

3.3. On-screen operation buttons

- You can perform main operations for the balance on the touch screen of the display unit.
Touch the on-screen buttons, buttons with text and selection buttons for operation.

Caution

- There are no double-click, drag or flip operations.
Do not perform these operations as they may result in wrong operations.
- Touch buttons with your finger, but not with a hard object.

Operation example

- Touch the **Back** button  to return to the previous screen.
- Touch a button with text to execute an input or operation that corresponds to the text.
- Touch a selection button to display selections.

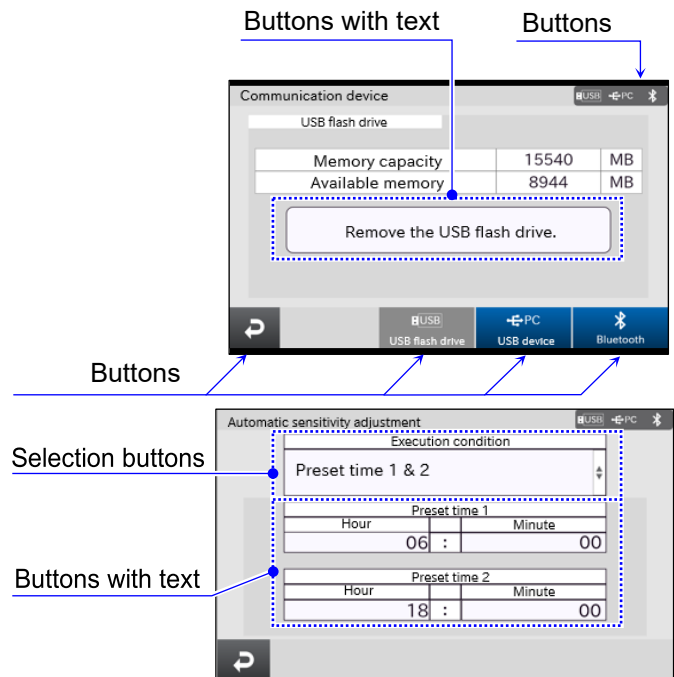

3.4. Input Screen

3.4.1. Numerical value input screen

- A numerical value input screen is displayed when you need to input numerical values.

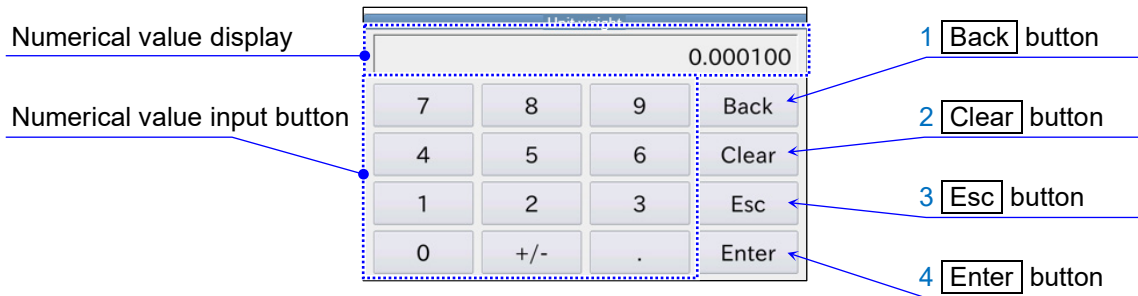

	Name	Description
1	Back button	Deletes the number right before the cursor.
2	Clear button	Deletes all input numbers.
3	Esc button	Returns to the original screen without reflecting the input numerical value.
4	Enter button	Touch this button after entering a numerical value to reflect the numerical value and return to the original screen. However, if the numerical value is out of range, touching this button returns to the original screen without applying the numerical value.

3.4.2. Character input screen

- A character input screen is displayed when you need to input characters.
On the character input screen, you can input alphanumerics and symbols.

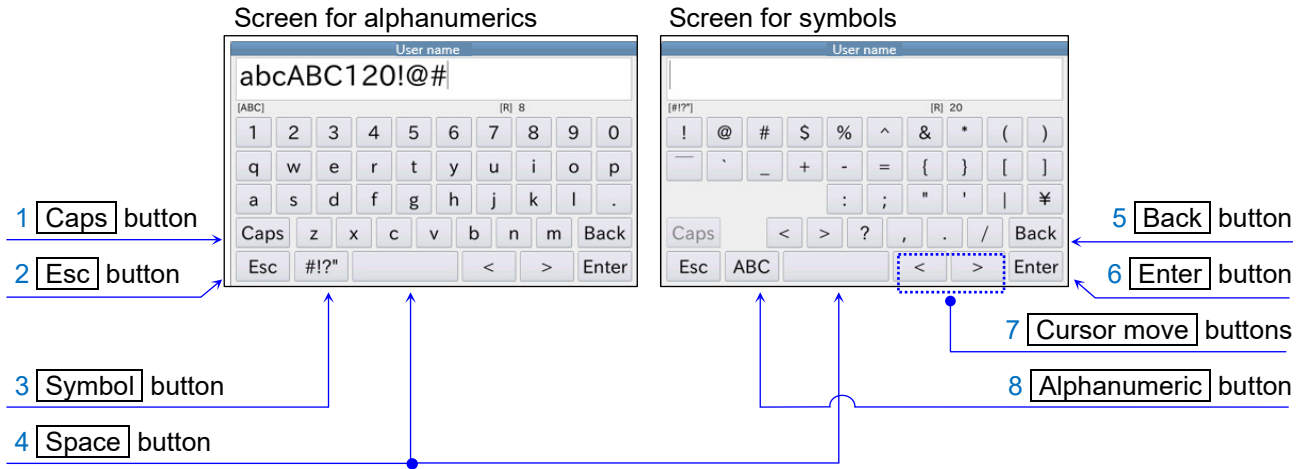

	Name	Description
1	Caps button	Switches between lower and upper cases.
2	Esc button	Returns to the original screen without reflecting the input characters.
3	Symbol button	Keys for inputting characters change to symbols.
4	Space button	Inputs space characters (space, ASCII 20h).
5	Back button	Deletes the character right before the cursor.
6	Enter button	Touch this button after entering a character value to reflect the character value and return to the original screen.
7	Cursor move buttons	Move the input cursor.
8	Alphanumeric button	Keys for inputting characters change to alphanumerics.

3.4.3. Password input screen

- A password input screen is displayed when you need to input a password. On the password input screen, you can input alphanumerics and symbols. Basic operations are the same as with the character input screen, but the input characters are displayed as “*”.
 - 1 Caps button
 - 2 Esc button
 - 3 Symbol button
 - 4 Space button
 - 5 Back button
 - 6 Enter button
 - 7 Cursor move buttons

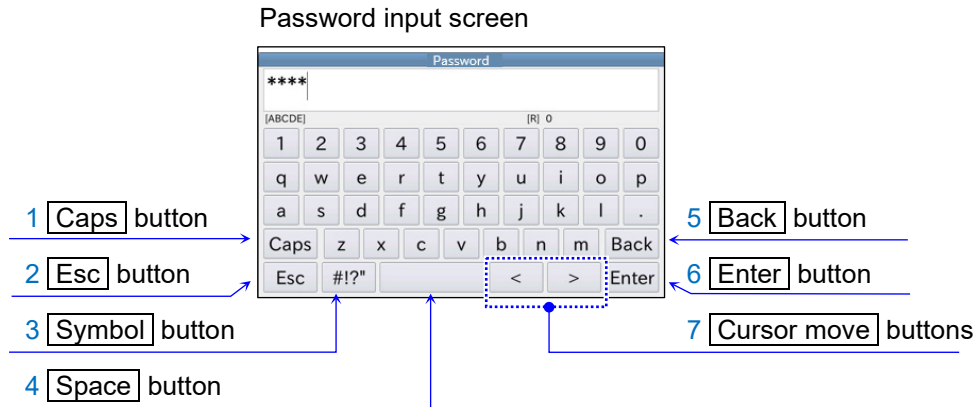



	Name	Description
1	Caps button	Switches between lower and upper cases.
2	Esc button	Returns to the original screen without reflecting the input characters.
3	Symbol button	Keys for inputting characters change to symbols.
4	Space button	Inputs space characters (space, ASCII 20h).
5	Back button	Deletes the character right before the cursor.
6	Enter button	Touch this button after entering a character value to reflect the character value and return to the original screen.
7	Cursor move buttons	Move the input cursor.

4. IR Sensors and Auto Doors



4.1. IR sensors

BA-T series analytical balances are equipped with IR sensors that allow operation without directly touching the balance display.

At factory settings, the IR sensors on the left and right of the display are assigned to open and close the breeze break doors.

You can turn the left and right IR sensors on and off or change them to operate other functions by using the **Left IR sensor function change** button  and the **Right IR sensor function change** button .

For details, refer to “[13.2. IR sensors](#)”.



Settings screen: **MENU** key  → **System settings** button  → **IR sensors** button  →
[IR sensors] settings screen

4.2. Auto doors

- BA-T series analytical balances are equipped with auto doors that allow you to open/close the breeze break without touching the doors.



- At factory settings, each breeze break door opens to the position it was previously opened to. You can also change the setting in the breeze break auto door settings screen so that the doors are fully open or partially open.

For details, refer to “[13.3. Breeze break auto doors](#)”.

Display settings: **MENU** key  → **System settings** button  → **Auto door** button  →
[Auto doors] settings screen

- You can also open and close the breeze break doors with the external switch AX-SW137-PRINT (or AX-SW137-REZERO) connected to the display unit connection terminal EXT.SW1 (or EXT.SW2) and in the [External input switch] screen.

For details, refer to “[13.20. External input switch](#)”.

Display settings: **MENU** key  → **System settings** button  → **External input switch** button  →
→ [External input switch] screen

Opening the breeze break door

- Step 1. If you want to open the breeze break door on the left side (or on the right side) when it is closed, hold your hand over the right IR sensor (or the left IR sensor).
- Step 2. The detection buzzer sounds and the breeze break door on the left (or right) side opens.

Closing the breeze break door

- Step 1. If you want to close the breeze break door on the left side (or on the right side) when it is open, hold your hand over the right IR sensor (or the left IR sensor).
- Step 2. The detection buzzer sounds and the breeze break door on the left (or right) side closes.

Operation example

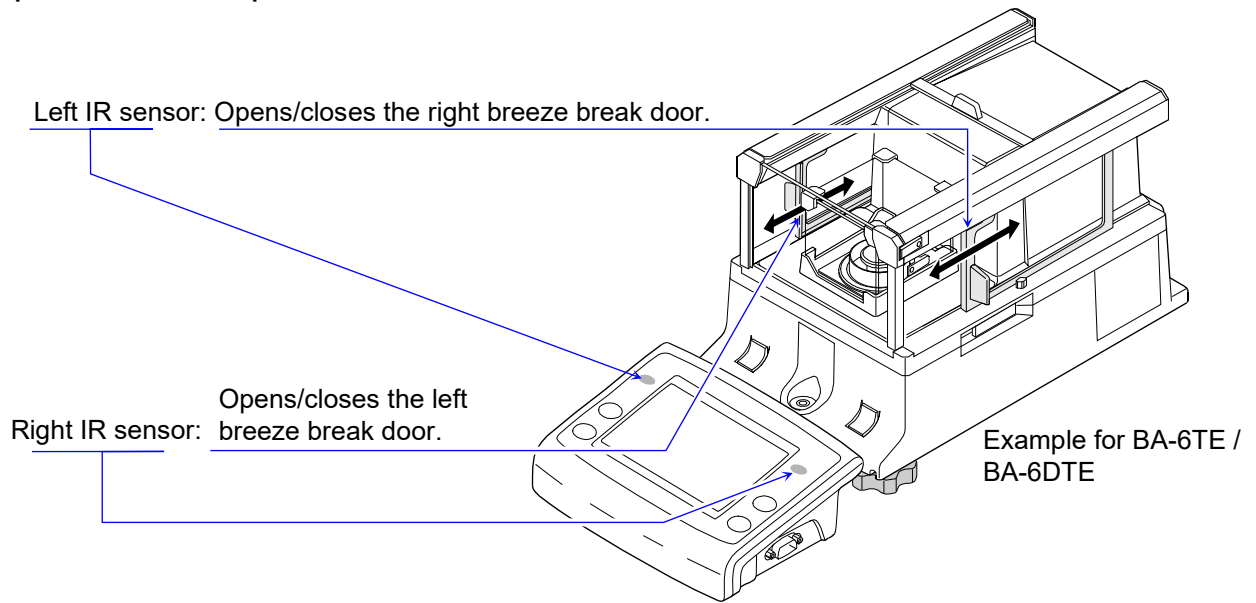

5. Application

5.1. Application settings screen

- The [Application] settings screen saves the settings related to weighing.

Display settings: [HOME] key  → [APP] button  → [Application] settings screen

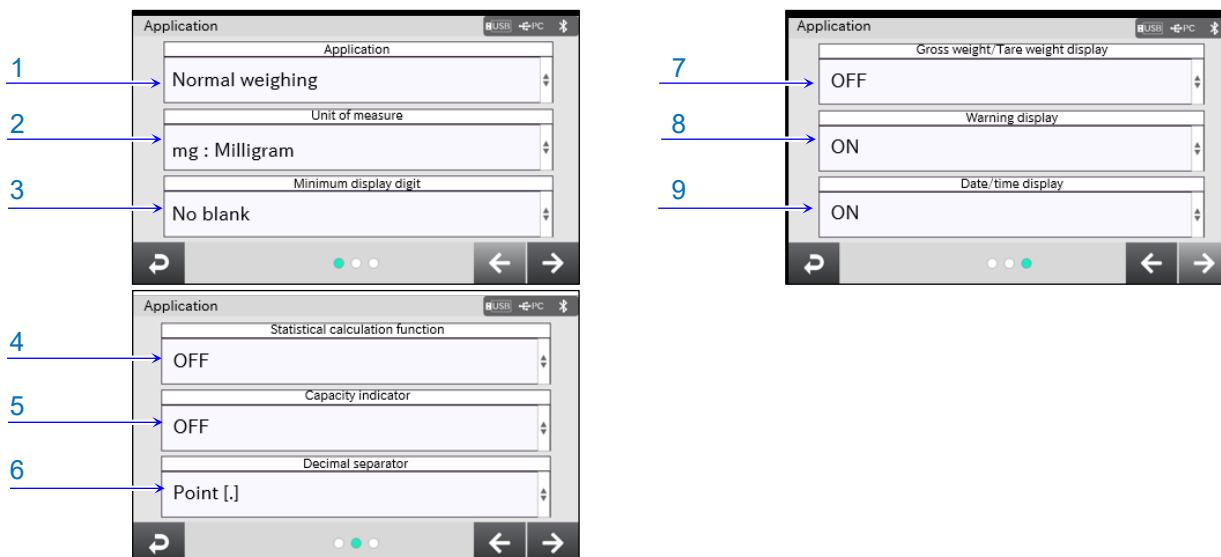

	Name	Setting value (setting range)	Description
1	Application selection	Normal weighing , Counting mode, Percent mode, Minimum weight alert function Formulation mode HPLC mode	Select the application to be used in the weighing screen.
2	Unit of measure *1	g: Gram , mg: Milligram (Refer to "5.1.1. Unit of measure".)	Select the unit of measure to be used in the normal weighing.
3	Minimum display digit	No blank , 1 digit blank, 2 digit blank	Select the minimum digit to be displayed for the normal weighing and minimum weight alert function.
4	Statistical calculation function	OFF , ON	Displays and outputs the statistical calculation result.
5	Capacity indicator	OFF , ON	Displays weighing values in a bar graph.
6	Decimal separator	Point [.] , Comma [,]	
7	Gross weight/Tare weight display	OFF , ON	Select to display the net/gross/tare function.
8	Warning display	OFF, ON	
9	Date/time display	OFF, ON	

Settings in the red box are default values (factory settings).

- *1 For BA-6TE / BA-6DTE, the factory setting is "mg".
For BA-125DTE / BA-225TE / BA-225DTE, the factory setting is "g".

5.1.1. Unit of measure

Available units of measure are configured before shipment.

For details about units of measure, refer to the table below.

Name (unit, mode)	Abbrev.	Conversion factor 1 g =
Gram	g	1 g
Milligram	mg	0.001 g
Ounce (Avoir)	OZ	28.349523125 g
Troy Ounce	OZt	31.1034768 g
Metric Carat	ct	0.2 g
Momme	mom	3.75 g
Pennyweight	dwt	1.55517384 g
Grain (UK)	GN	0.06479891 g
Tael (HK general, Singapore)	TL	37.7994 g
Tael (HK jewelry)		37.429 g
Tael (Taiwan)		37.5 g
Tael (China)		31.25 g
Tola (India)	tol	11.6638038 g
Messghal	MES	4.6875 g

The following tables show the capacity and readability for each unit according to the model of the balance.

Unit	BA-6TE	
	Precision range	
	Capacity	Readability
Gram	6.20	0.000001
Milligram	6200	0.001
Once (Avoir)	0.218	0.0000001
Troy Once	0.199	0.0000001
Metric Carat	31.0	0.00001
Momme	1.65	0.000001
Pennyweight	3.98	0.000001
Grain (UK)	95.6	0.00002
Tael (HK general, Singapore)	0.164	0.0000001
Tael (HK jewelry)	0.165	0.0000001
Tael (Taiwan)	0.165	0.0000001
Tael (China)	0.198	0.0000001
Tola (India)	0.531	0.0000001
Messghal	1.32	0.000001

Unit	BA-6DTE			
	Precision range		Standard range	
	Capacity	Readability	Capacity	Readability
Gram	2.10	0.000001	6.20	0.00001
Milligram	2100	0.001	6200	0.01
Once (Avoir)	0.0740	0.0000001	0.218	0.000001
Troy Once	0.0675	0.0000001	0.199	0.000001
Metric Carat	10.5	0.00001	31.0	0.0001
Momme	0.56	0.000001	1.65	0.00001
Pennyweight	1.35	0.000001	3.98	0.00001
Grain (UK)	32.4	0.00002	95.6	0.0001
Tael (HK general, Singapore)	0.0555	0.0000001	0.164	0.000001
Tael (HK jewelry)	0.0561	0.0000001	0.165	0.000001
Tael (Taiwan)	0.0560	0.0000001	0.165	0.000001
Tael (China)	0.0672	0.0000001	0.198	0.000001
Tola (India)	0.180	0.0000001	0.531	0.000001
Messghal	0.448	0.000001	1.32	0.00001

Unit	BA-225TE	
	Precision range	
	Capacity	Readability
Gram	220	0.00001
Milligram	220000	0.01
Once (Avoir)	7.76	0.000001
Troy Once	7.07	0.000001
Metric Carat	1100	0.0001
Momme	58.6	0.00001
Pennyweight	141	0.00001
Grain (UK)	3395	0.0002
Tael (HK general, Singapore)	5.82	0.000001
Tael (HK jewelry)	5.87	0.000001
Tael (Taiwan)	5.86	0.000001
Tael (China)	7.04	0.000001
Tola (India)	18.8	0.000001
Messghal	46.9	0.00001



Unit	BA-225DTE			
	Precision range		Standard range	
	Capacity	Readability	Capacity	Readability
Gram	51.0	0.00001	220	0.0001
Milligram	51000	0.01	220000	0.1
Once (Avoir)	1.79	0.000001	7.76	0.00001
Troy Once	1.63	0.000001	7.07	0.00001
Metric Carat	255	0.0001	1100	0.001
Momme	13.6	0.00001	58.6	0.0001
Pennyweight	32.7	0.00001	141	0.0001
Grain (UK)	787	0.0002	3395	0.001
Tael (HK general, Singapore)	1.34	0.000001	5.82	0.00001
Tael (HK jewelry)	1.36	0.000001	5.87	0.00001
Tael (Taiwan)	1.36	0.000001	5.86	0.00001
Tael (China)	1.63	0.000001	7.04	0.00001
Tola (India)	4.37	0.000001	18.8	0.00001
Messghal	10.8	0.00001	46.9	0.0001

Unit	BA-125DTE			
	Precision range		Standard range	
	Capacity	Readability	Capacity	Readability
Gram	51.0	0.00001	120	0.0001
Milligram	51000	0.01	120000	0.1
Ounce (Avoir)	1.79	0.000001	4.23	0.00001
Troy Ounce	1.63	0.000001	3.85	0.00001
Metric Carat	255	0.0001	600	0.001
Momme	13.6	0.00001	32.0	0.0001
Pennyweight	32.7	0.00001	77	0.0001
Grain (UK)	787	0.0002	1851	0.001
Tael (HK general, Singapore)	1.34	0.000001	3.17	0.00001
Tael (HK jewelry)	1.36	0.000001	3.20	0.00001
Tael (Taiwan)	1.36	0.000001	3.20	0.00001
Tael (China)	1.63	0.000001	3.84	0.00001
Tola (India)	4.37	0.000001	10.2	0.00001
Messghal	10.8	0.00001	25.6	0.0001

5.2. Normal weighing

5.2.1. Basic weighing

Example weighing in g for BA-6TE

- Step 1. Press the **ON:OFF** key  or the **HOME** key  to enter weighing mode.
- Step 2. Place a container (tare) on the weighing pan if necessary. Press the **RE-ZERO** button  to set the weighing value to zero.
(The decimal separator position depends on the balance model.)
- Step 3. Place a sample on the pan or in the container. Wait for the stabilization indicator to be displayed. Read the value.
- Step 4. Remove the sample and container from the weighing pan.

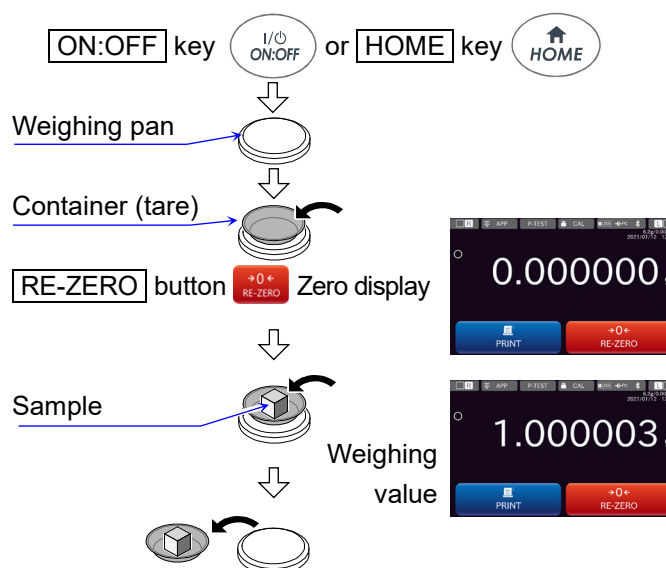

Zero after subtracting the tare

- Step 1. If you press the **ON:OFF** key  with a container (tare) placed on the weighing pan to display the weighing value, zero is displayed after automatically subtracting the tare. (Zero display after subtracting the tare)

Caution

- In the zero display after subtracting the tare, the range available for weighing becomes narrower than the maximum display (capacity).
Range available for weighing = Maximum display - Tare weight
- For details about the range available for weighing up to the capacity in the zero display during sensitivity adjustment when the screen display is turned on, refer to “[5.2.2. Zero-point, tare, and weighing range](#)”.

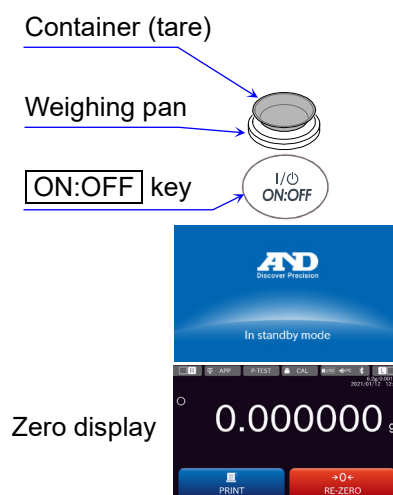

5.2.2. Zero-point, tare, and weighing range

Entering the weighing mode

- The balance will determine the reference zero point when the **ON:OFF** key  is pressed to enter the weighing mode.

Depending on the load condition at that time, the balance automatically judges whether to set the zero-point or to tare.

The condition for determining which is used is the "power-on zero range", and when the power-on zero range is exceeded, the tare operation is performed.

Re-zero operation

- By pressing the **RE-ZERO** button , the displayed value can be set to zero.

The re-zero operation with the **RE-ZERO** button  will automatically judge whether to set the zero-point or to tare.

Weighing range

- The weight range that the balance can display varies depending on the model. When the gross weight weighed exceeds the maximum display, **E** is displayed to indicate that the weighing range is exceeded. When exceeded in the negative direction, **-E** is displayed.

Gross weight = Net weight (weighing value minus tare) + Tare weight

Model	Power-on zero range	Zero range	-E display range
BA-6TE BA-6DTE	Approx. ±0.6 g	Approx. -0.6 g to +0.1 g	Approx. -0.6 g
BA-225TE BA-225DTE	Approx. ±22 g	Approx. -22 g to +4.4 g	Approx. -22 g
BA-125DTE	Approx. ±12 g	Approx. -12 g to +2.4 g	Approx. -12 g

5.2.3. Smart range function

- For BA-6DTE / BA-225DTE / BA-125DTE, there are two types of ranges: the standard range and precision range (high resolution).

Smart range function



- The range can switch automatically between the standard range and precision range (high resolution), depending on the value displayed.

Pressing the **RE-ZERO** button  to set the displayed value to zero allows for weighing in the precision range, regardless of the tare value. The range can be fixed to the standard range by using [Minimum display digit] in the [Application] settings screen.

Display settings: **HOME** key  → **APP** button  → [Application] settings screen
Minimum display digit button → Select from [No blank], [1 digit blank], [2 digit blank].

Operation example

Example weighing in g for BA-6DTE

- Step 1. Start weighing in the precision range.
Press the **RE-ZERO** button  to set the display to zero and enable the precision range.
- Step 2. Place a container on the weighing pan.
When the displayed value exceeds the precision range, the balance automatically switches to the standard range.
- Step 3. Press the **RE-ZERO** button  to set the display to zero and enable the precision range.
- Step 4. Place a sample in the container.
If the weighing value does not exceed the precision range, the sample can be weighed in the precision range.
- Step 5. Remove the sample and container from the weighing pan.

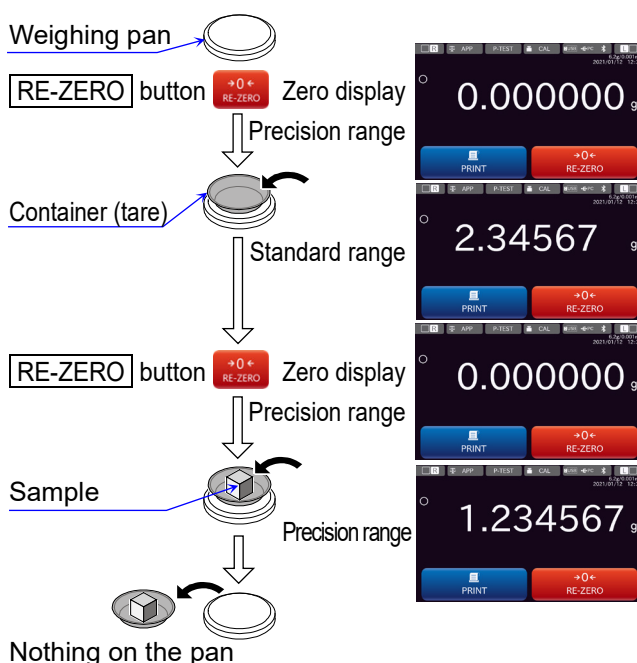



Precision range and standard range

Model	Unit	Precision range after pressing the RE-ZERO button 	Standard range
BA-6DTE	g gram	0.000000 g - 2.100009 g	2.10001 g - 6.20008 g
	mg milligram	0.000 mg - 2100.009 mg	2100.01 mg - 6200.08 mg
BA-225DTE	g gram	0.00000 g - 51.00009 g	51.0001 g - 220.0008 g
	mg milligram	0.00 mg - 51000.09 mg	51000.1 mg - 220000.8 mg
BA-125DTE	g gram	0.00000 g - 51.00009 g	51.0001 g - 120.0008 g
	mg milligram	0.00 mg - 51000.09 mg	51000.1 mg - 120000.8 mg

5.3. Counting mode (PCS)

- If you configure this display, the [HOME] screen changes to Counting mode.

Display settings: [HOME] key  → [APP] button  → [Application] settings screen
 [Application selection] button → Select [Counting mode].
 [HOME] key  → [Counting mode] screen

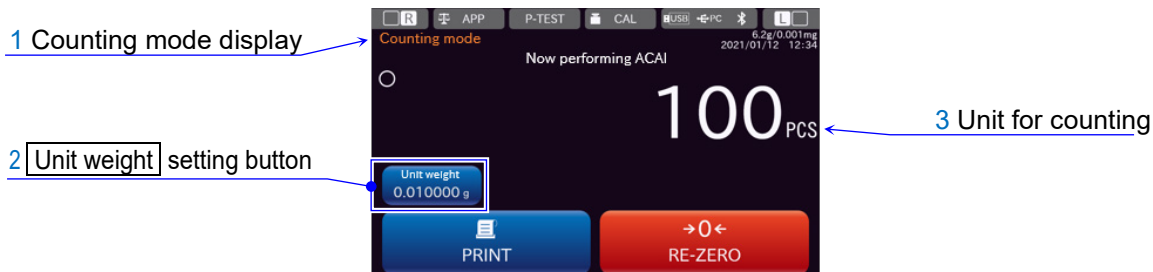



	Name	Description
1	Counting mode display	Displayed in the Counting mode.
2	[Unit weight] setting button	Displays the [Counting mode setting] screen described in "5.3.1. Storing a unit weight", where the stored unit weight is displayed. You can also change the unit weight.

Counting mode usage

- This is the mode to determine the number of objects in a sample. Based on the reference sample unit weight (weight per piece), the balance calculates and displays how many pieces the sample weight corresponds to. The smaller the variation in the unit weight of sample pieces is, the more accurate the count will be. The balance is equipped with the Automatic Counting Accuracy Improvement (ACAI) function to improve the counting accuracy.
 - * It is recommended that the unit weight (weight per piece) of the sample should be 0.1 mg or more.
 - * If there is a large variation in the unit weight of sample pieces, it may not be possible to count accurately.
 - * If a large error is found in the counting measurement, try a method such as performing ACAI frequently or multiple measurements.

5.3.1. Storing a unit weight

[Counting mode setting] screen

Display settings: **HOME** key  → **APP** button  APP → [Application] settings screen
Application selection button → Select [Counting mode].
HOME key  → [Counting mode] screen → **Unit weight** setting button →
 Unit weight [Counting mode setting] screen

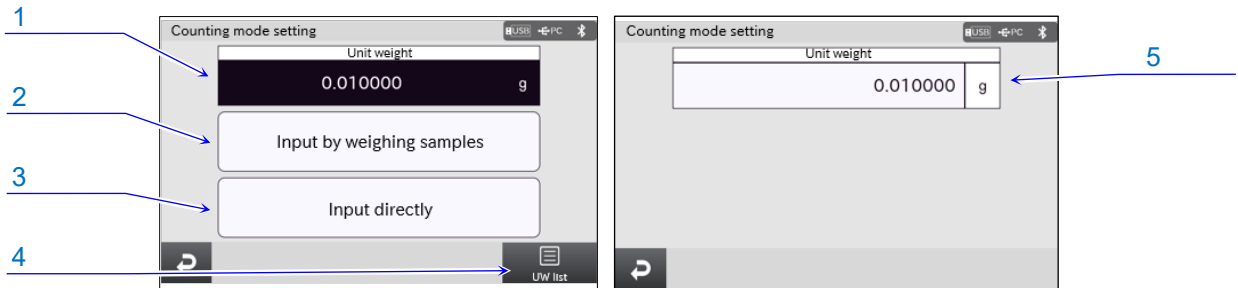



	Name	Description
1	Unit weight display	Displays the unit weight through the direct input or input by weighing samples.
2	Input by weighing samples button	Displays the Counting mode [Sample input mode] screen.
3	Input directly button	Displays the numerical value input screen for the unit weight.
4	UW list button	Displays the [Unit weight list] screen.
5	Unit weight input button	Input the unit weight. Input range: 0.1 mg to capacity for each model

□ This screen is used to store the unit weight for the Counting mode.

5.3.2. Counting mode sample input

[Sample input mode] screen

Display settings: **HOME** key  → **APP** button  → [Application] settings screen
Application selection button → Select [Counting mode].
HOME key  → [Counting mode] screen → **Unit weight** setting button →
Input by weighing samples button → Counting mode [Sample input mode] screen

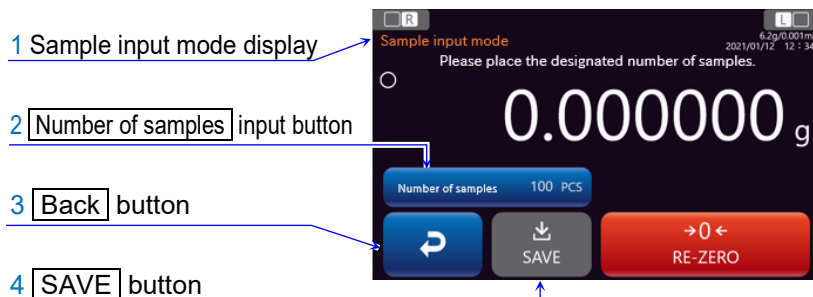



	Name	Description
1	Sample input mode display	Displayed in the Counting mode sample input mode.
2	Number of samples input button	Input the number of samples for the input by weighing samples. Input range: 10 - 10000 pcs (10 - 100 pcs with the touch screen software version 1.020 or earlier)
3	Back button	Displays the [Counting mode] screen.
4	SAVE button	Store the unit weight based on the current weight value and number of samples.

□ This screen is used to input the unit weight by weighing samples for the Counting mode.

How to store the unit weight

Counting example for BA-6DTE

- Step 1. Press the **Number of samples** input button.
- * Note that a greater number of sample pieces will yield more accurate counting result since the sample unit weight is usually considered to vary more or less.
- Step 2. Place a container on the weighing pan and press the **RE-ZERO** button  to set the weighing value to zero.
- Step 3. Place the specified number of sample pieces on the container/weighing pan.
- Step 4. Press the **SAVE** button . When “The unit weight has been stored.” is displayed, the storage is complete.
 Press the **HOME** key  to return to the Counting mode screen.

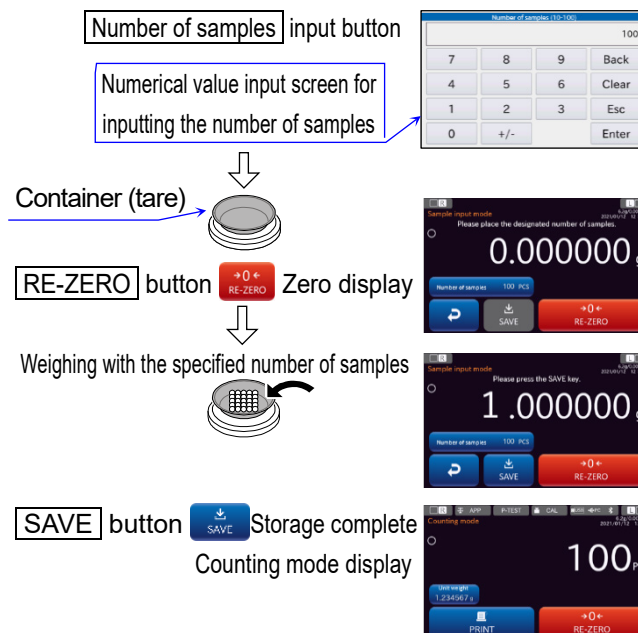

Caution

- If the balance judges that the unit weight is too light to be stored, the **SAVE** button  is disabled. The stored unit weight is stored in nonvolatile memory even if the power is removed.

5.3.3. ACAI function

The ACAI function automatically improves the counting accuracy each time the number of sample pieces is increased.

Errors will be reduced as variations in sample weight are averaged.

Step 1. After storing the unit weight through the input by weighing samples and adding some sample pieces in the Counting mode screen, "Now performing ACAI" (updating the counting precision) is displayed.

Caution on how to add sample pieces

Add three or more sample pieces to prevent malfunction.

The function does not turn on with too many sample pieces on the weighing pan. Add approximately the same number of sample pieces as displayed.

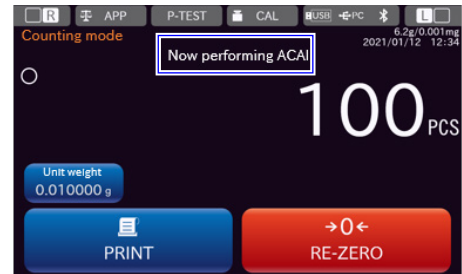

Step 2. While "Now performing ACAI" (updating the counting precision) is displayed, do not move sample pieces.

Step 3. "ACAI has been performed" is displayed and the precision is updated.



Each time this process is repeated, the counting accuracy will improve further.

The range of ACAI after exceeding 100 is not predetermined. Add approximately the same number of sample pieces as displayed.

Step 4. Remove all the sample pieces used with ACAI from the weighing pan and start counting work.

- ACAI does not function if the displayed value is set to zero, for example, by pressing the **RE-ZERO** button .
- If the unit weight is stored through the unit weight input field, the ACAI function is not activated.

5.3.4. Unit weight list

Display settings: **HOME** key  → **APP** button  → [Application] settings screen
Application selection button → Select [Counting mode].

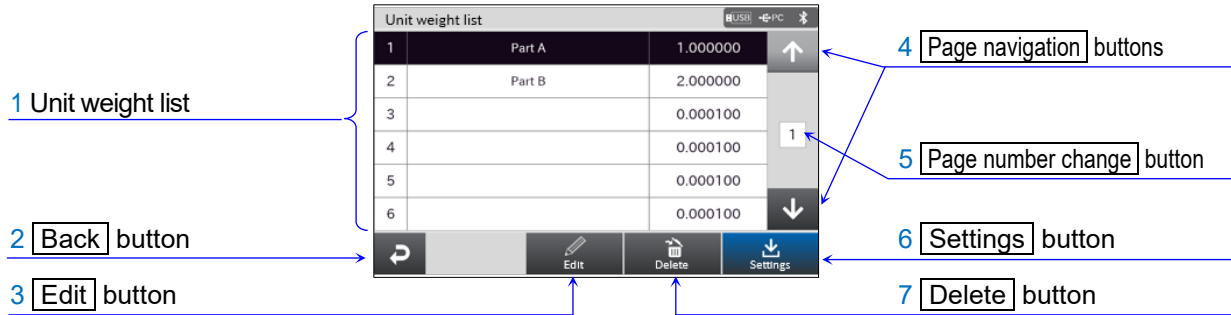

HOME key  → [Counting mode] screen → **Unit weight** setting button →
UW list button → [Unit weight list] screen



	Name	Description
1	Unit weight list	Displays the stored unit weights.
2	Back button	Displays the [Counting mode setting] screen.
3	Edit button	Edits the data for the unit weight selected in the unit weight list. Displays the screen described in “5.3.5. Editing and storing a unit weight [Counting mode setting] screen”.
4	Page navigation buttons	Used to navigate the unit weight list page.
5	Page number change button	Changes the number of the unit weight list page. Input range: 1 - 9
6	Settings button	Sets the unit weight data selected in the unit weight list as the unit weight to be used.
7	Delete button	Deletes the data of the unit weight selected in the unit weight list to return it to the initial value. Initial value Name: Blank Unit weight: 0.0001 g

The unit weight list can store up to 50 unit weights.

5.3.5. Editing and storing a unit weight [Counting mode setting] screen

Display settings: **HOME** key  → **APP** button  → [Application] settings screen
Application selection button → Select [Counting mode].
HOME key  → [Counting mode] screen → **UW list** button →
Edit button → [Counting mode setting] screen for editing and storing a unit weight.

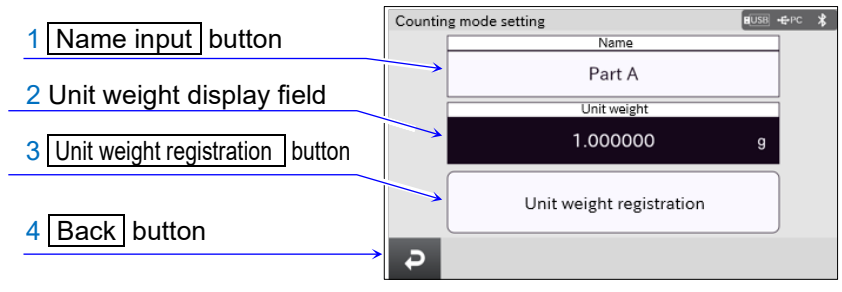



	Name	Description
1	Name input button	Displays the name of the stored unit weight. A new name can be entered.
2	Unit weight display field	Displays the stored unit weight.
3	Unit weight registration button	Displays the [Counting mode setting] screen where the stored unit weight can be changed.
4	Back button	Displays the [Unit weight list] screen.

5.4. Percent weighing

[Percent weighing] screen

- If you configure this display, the HOME screen changes to the Percent mode.

Display settings: **HOME** key  → **APP** button  → [Application] settings screen

Application selection button → Select [Percent mode].

HOME key  → [Percent mode] screen





	Name	Description
1	Percent mode display	Displayed in the Percent mode.
2	Percent mode setting button	Displays the [Percent mode setting] screen. Also displays the currently stored 100% reference mass.

Percent mode usage

- The percent mode displays the weighing value in a percentage compared with a reference mass as 100%. This is useful for target weighing or sample variance checks.

5.4.1. Storing the 100% reference mass

[Percent mode setting] screen

Display settings: **HOME** key  → **APP** button  → [Application] settings screen

Application selection button → Select [Percent mode]

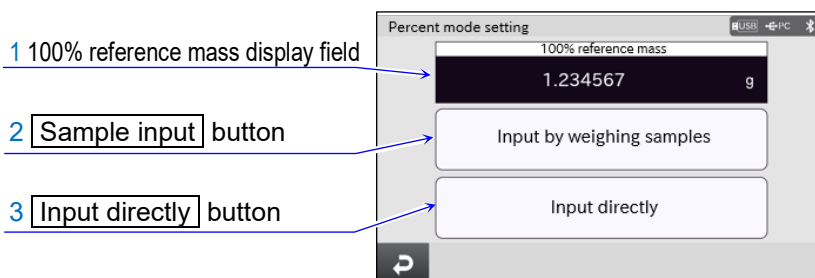

HOME key  → [Percent mode setting] screen → **Percent mode setting** button → [Percent mode setting] screen



	Name	Description
1	100% reference mass display field	Displays the 100% reference mass.
2	Sample input button	Displays the Percent mode sample input screen.
3	Input directly button	Displays the numerical value input display for the 100% reference mass.

- This screen is used to set the 100% reference mass for the Percent mode.

5.4.2. Percent mode sample input [Sample input mode] screen

Display settings: [HOME] key  → [APP] button  → [Application] settings screen
 [Application selection] button → Select [Percent mode]
 [HOME] key  → [Percent mode] screen → [Percent mode setting] button →
 [Sample input] button → [Sample input mode] screen



	Name	Description
1	Sample input mode display	Displayed in the Percent mode sample input mode.
2	[SAVE] button	Stores the 100% reference mass.
3	[Back] button	Displays the [Percent mode setting] screen.

□ This screen is used to input the 100% reference mass for the Percent mode by weighing samples.

How to store the reference mass

Weighing example for BA-6DTE

Step 1. Place a container on the weighing pan if necessary and press the [RE-ZERO] button  to set the weighing value to zero.

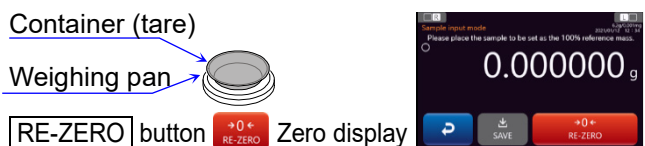

Step 2. Place the specified number of sample pieces on the container/weighing pan.

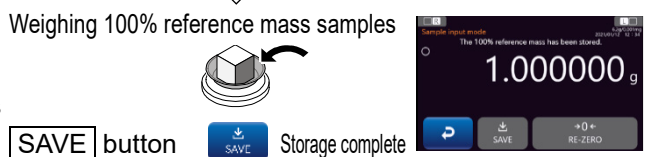

Step 3. Press the [SAVE] button . "The 100 % reference mass has been stored." is displayed.

Press the [HOME] key  to return to the Percent mode screen.



Weighing example When samples are weighed, the percent is displayed.



Caution

- If the balance judges that the sample reference mass for 100% is too light to be stored, the [SAVE] button  is disabled.
- The decimal separator position varies according to the 100% reference mass.
- The stored 100% reference mass is stored in nonvolatile memory even if the power is removed.

Model	100% reference mass	Decimal separator position
BA-6TE / BA-6DTE	0.0010 g - 0.0099 g	1 %
	0.0100 g - 0.0999 g	0.1 %
	0.1000 g -	0.01 %
BA-225TE / BA-225DTE / BA-125DTE	0.0100 g - 0.0999 g	1 %
	0.1000 g - 0.9999 g	0.1 %
	1.0000 g -	0.01 %

5.5. Minimum weight alert function

- If you configure this display, the HOME screen changes to the weighing screen with the minimum weight alert function.

Display settings: **HOME** key  → **APP** button  → [Application] settings screen
Application selection button → Select [Minimum weight alert function].
HOME key  → Weighing screen with the minimum weight alert function





	Name	Description
1	Minimum weight alert function	Displayed when the minimum weight alert function is enabled.
2	Minimum weight setting button	Displays the [Minimum weight setting] screen. Also displays the currently stored minimum weight.
3	Minimum weight alert display	Displayed when the sample weight is less than the set minimum weight.

- This is the screen for the minimum weight alert function. This function can be used only with the unit "mg".

Minimum weight alert function usage

- Minimum weight is the minimum sample weight required to perform correct quantitative analysis taking the measurement error of the balance used into account. If the sample amount is too small, the proportion of measurement error in the measured value increases, and the reliability of the analysis result thus may drop.
- The minimum weight alert function makes it possible to judge immediately whether the sample amount meets the set minimum weight.

5.5.1. Minimum weight setting

Display settings: **HOME** key  → **APP** button  → [Application] settings screen
Application selection button → Select [Minimum weight alert function].
HOME key  → Weighing screen with the minimum weight alert function →
Minimum weight setting button → [Minimum weight setting] screen

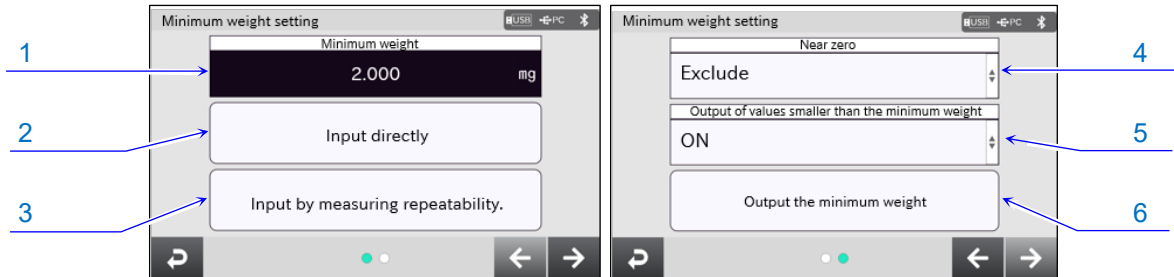



	Name	Setting value	Description
1	Minimum weight display	-	Displays the currently stored minimum weight.
2	Input directly button	—	Displays the minimum weight input screen.
3	Input by measuring repeatability button	—	Displays the [Minimum weight setting] screen for measurement.
4	Comparison near zero	Include Exclude	Select whether to include or exclude near zero for the minimum weight alert display.*
5	Outputting data less than the minimum weight	OFF ON	If set to OFF, data with the weighing value less than the minimum weight is not output.
6	Output the minimum weight button	—	Outputs the minimum weight.

 Settings in the red box are default values (factory settings).

* Near zero is within ± 12 d of 0 mg. "d" is a unit of readability.

□ This is the screen for setting the minimum weight.

5.5.2. Minimum weight input

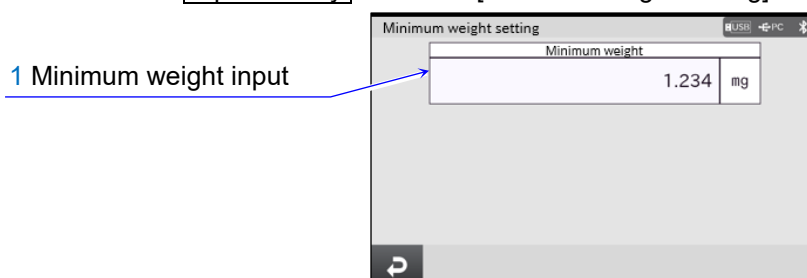

Display settings: **HOME** key  → **APP** button  → [Application] settings screen
Application selection button → Select [Minimum weight alert function].
HOME key  → Weighing screen with the minimum weight alert function →
Minimum weight setting button →
Input directly button → [Minimum weight setting] screen



	Name	Setting value	Description
1	Minimum weight input	0 g to capacity	Input the minimum weight.

□ This is the screen for inputting the minimum weight.

5.5.3. Minimum weight setting for measurement

Display settings: [HOME] key  → [APP] button  → [Application] settings screen
 [Application selection] button → Select [Minimum weight alert function]
 [HOME] key  → Weighing screen with the minimum weight alert function →
 [Minimum weight setting] button →
 [Input by measuring repeatability] button → [Minimum weight setting] screen

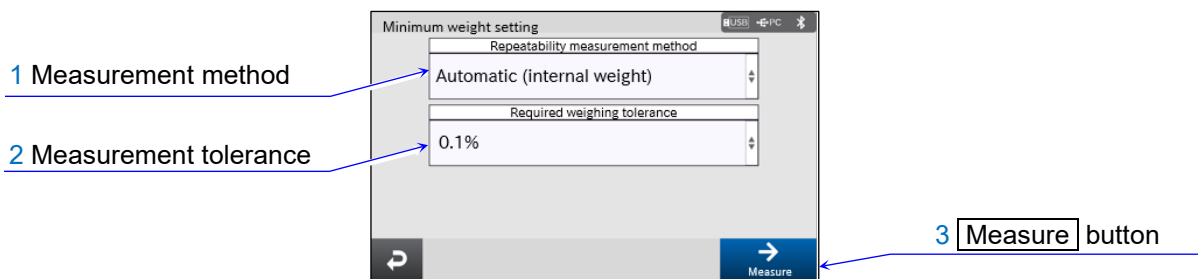

	Name	Setting value	Description
1	Minimum weight measurement method	Automatic (internal weight) Manual (external weight)	Select the minimum weight measurement method.
2	Minimum weight measurement tolerance	0.1 % 1.0 %	Select the minimum weight measurement tolerance.
3	[Measure] button	—	Start the minimum weight measurement. When the measurement is complete, the [Minimum weight measurement result] screen described in “5.5.4. Minimum weight measurement result” is displayed.

 Settings in the red box are default values (factory settings).

□ This is the screen for measuring the minimum weight.

Automatic (internal weight)

For this setting, the minimum weight is automatically measured with the internal weight in the [Repeatability measurement mode] screen. When the measurement is complete, the [Minimum weight measurement result] screen described in “5.5.4. Minimum weight measurement result” is displayed.





	Name	Description
1	[Back] button	Returns to the previous screen.

Manual (external weight)

For this setting, measurement is performed with your weight to compute the minimum weight.



The procedure is displayed in the message field.

Weighing example for BA-6DTE

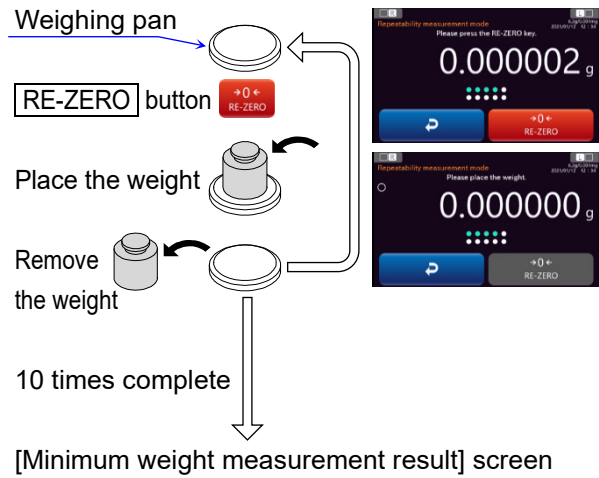
- Step 1. Press the **RE-ZERO** button .
- Step 2. Place a weight on the weighing pan.
- Step 3. Remove the weight when the stabilization indicator  is displayed.
- Step 4. Repeat steps 1, 2 and 3 ten times.
- Step 5. When the measurement is complete, the [Minimum weight measurement result] screen described in [“5.5.4. Minimum weight measurement result”](#) is displayed.



5.5.4. Minimum weight measurement result

Display settings: **HOME** key  → **APP** button  → [Application] settings screen
Application selection button → Select [Minimum weight alert function]
HOME key  → Weighing screen with the minimum weight alert function →
Minimum weight setting button →
Input by measuring repeatability button → [Minimum weight setting] screen →
Measure button → [Minimum weight measurement result] screen.

- The [Minimum weight measurement result] screen is displayed when the [5.5.3. Minimum weight setting for measurement](#) is complete.

1 Measurement method

2 Measurement tolerance

3 Repeatability (standard deviation)

4 Minimum weight

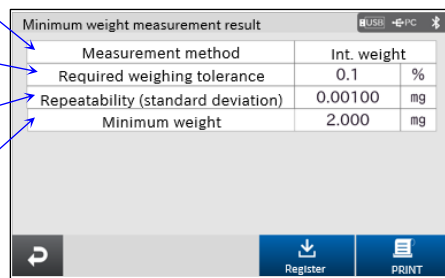

Measurement method	Int. weight	
Required weighing tolerance	0.1	%
Repeatability (standard deviation)	0.00100	mg
Minimum weight	2.000	mg

5 **PRINT** button

6 **Register** button

	Name	Description
1	Measurement method	Displays the method used for the minimum weight measurement.
2	Measurement tolerance	Displays the minimum weight measurement tolerance.
3	Repeatability (standard deviation)	Displays the standard deviation for this measurement.
4	Minimum weight	Displays the minimum weight.
5	PRINT button	Outputs the minimum weight measurement result to the device connected to the balance.
6	Register button	Registers the minimum weight.

- * If the repeatability (standard deviation) is 0.41d or less, the minimum weight is 2000 times the 0.41d in compliance with USP.
"d" is a unit of readability.



5.6. Formulation function

Formulation function usage





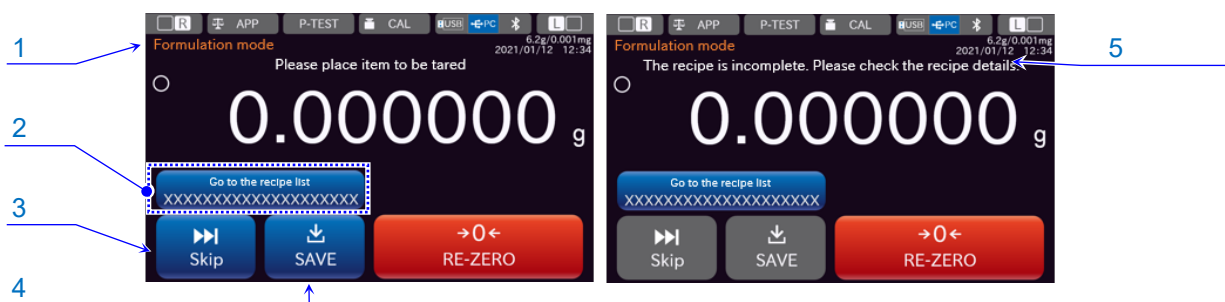

- This is the function to store a recipe consisting of the sample to be weighed, the target weight, and the tolerance of the amount to be weighed with the balance, and to weigh according to the recipe.
- If you configure this display, the HOME screen changes to formulation mode.

Caution

- The contents of the stored recipes and sample information will be cleared by initializing the balance.



Display settings: [HOME] key  → [APP] button  → [Application] settings screen
 [Application selection] button → Select [Formulation mode]
 [HOME] key  → [Formulation mode] screen



	Name	Description
1	Formulation mode	Displayed when in the formulation mode.
2	[Go to the recipe list] button	Displays the [Recipe list] screen. The name of the currently selected recipe is displayed here.
3	[Skip] button 	Skips tare weighing and displays the [Formulation mode - Sample weighing] screen. If the recipe is incomplete, the button is disabled.
4	[SAVE] button 	Weighs the tare value and displays the [Formulation mode - Sample weighing] screen. If the recipe is incomplete, the [SAVE] button  is disabled. If the weighing value is negative, it is recorded as 0 g.
5	Display indicating that the recipe is incomplete	If the selected recipe is incomplete: The message "The recipe is incomplete. Please check the recipe details." is displayed and the [Skip] button  and [SAVE] button  are disabled. Check the recipe name and the target value and tolerance of the sample registered in the recipe. If the selected recipe is complete: The message "Please place item to be tared" is displayed and the [Skip] button  and [SAVE] button  are enabled.

- This is the screen for [Formulation mode]. This mode can be used only with the unit "g".
- Re-zero will be applied automatically when the screen changes to [Formulation mode].
- If the tare weight plus sample target value exceeds the capacity, the message "Overload error" is displayed for the item indicated by 5 in the figure above and the [SAVE] button  is disabled.

5.6.1. Selecting a recipe

Display settings: [HOME] key  → [APP] button  → [Application] settings screen
 [Application selection] button → Select [Formulation mode]
 [HOME] key  → [Formulation mode] screen → [Go to the recipe list] button →
 [Recipe list] screen

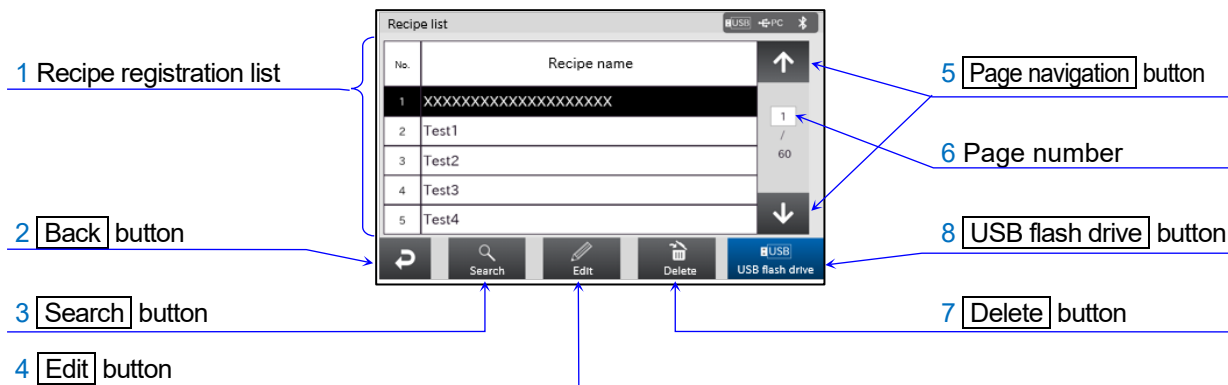



	Name	Description
1	Recipe registration list	Displays the list of registered recipes. Touch a recipe to select. The selected recipe is highlighted in black.
2	[Back] button	Displays the [Formulation mode] screen.
3	[Search] button	Displays the [Recipe search] screen.
4	[Edit] button	Displays the [Recipe edit] screen.
5	[Page navigation] button	Navigates to the previous/next recipe registration list page.
6	Page number	Displays the current page number. To display another page, touch this field and enter the page number.
7	[Delete] button	Deletes the selected recipe.
8	[USB flash drive] button	Displays the [Export/import recipe] screen.*

- Up to 300 recipes can be registered in total.
- If you have many recipes registered and it is difficult to find one from the list, the recipe search function will come in useful.

* Supported with the touch panel software version 1.019 or later

5.6.2. Searching a recipe

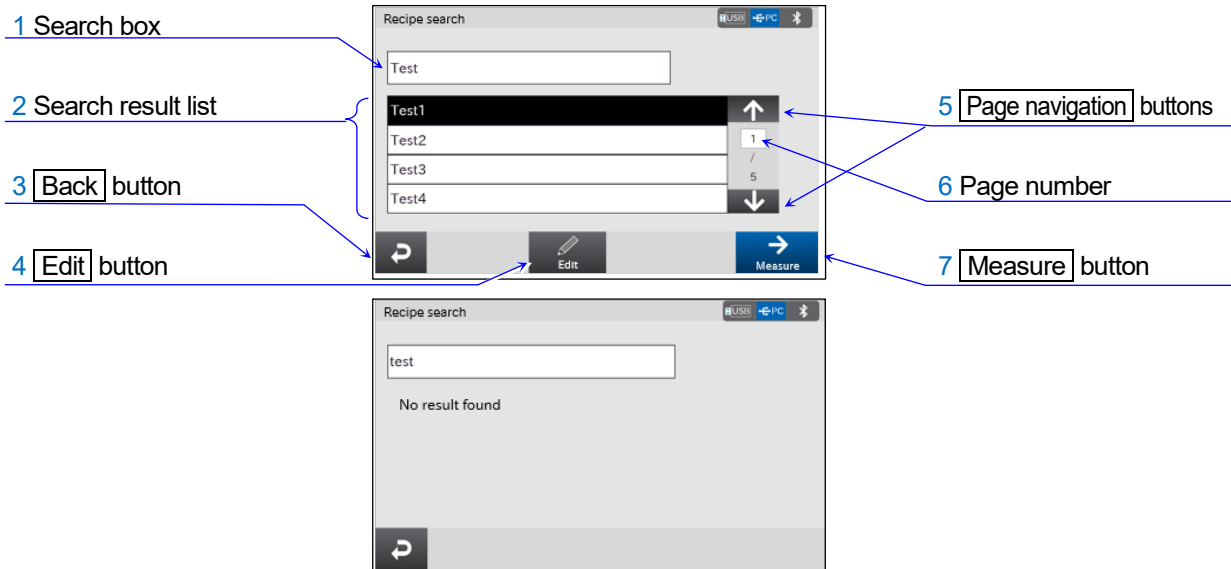

Display settings: **HOME** key  → **APP** button  → [Application] settings screen
Application selection button → Select [Formulation mode]
HOME key  → [Formulation mode] screen → **Go to the recipe list** button →
Search button → [Recipe search] screen



	Name	Description
1	Search box	Enter the search term. The search method is prefix search. If there is no search result, the message "No result found" is displayed.
2	Search result list	Displays the list of search results. Touch a recipe to select. The selected recipe is highlighted in black.
3	Back button	Displays the [Recipe list] screen.
4	Edit button	Displays the [Recipe edit] screen. Edit the contents of the selected recipe.
5	Page navigation button	Navigates to the previous/next search result page.
6	Page number	Displays the current page number. To display another page, touch this field and enter the page number.
7	Measure button	Displays the [Formulation mode] screen and starts measuring with the selected recipe.

- The **Edit** button and **Measure** button only appear when the search results are displayed.

5.6.3. Editing a recipe

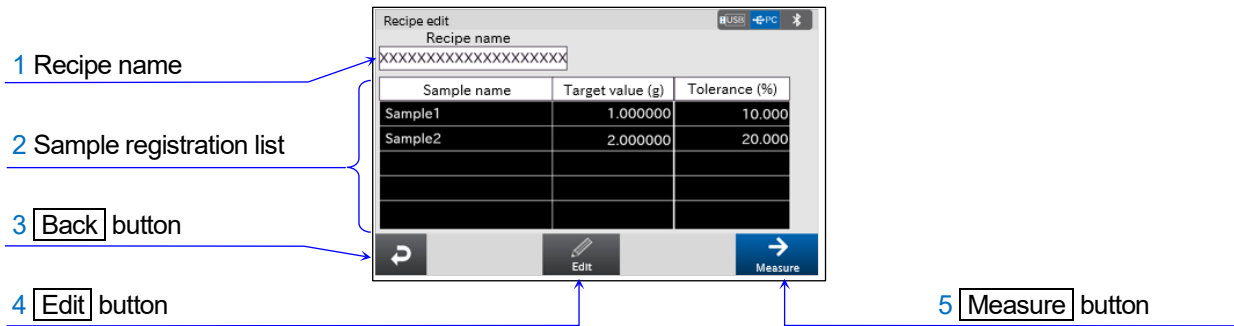

Display settings: **HOME** key  → **APP** button  → [Application] settings screen
Application selection button → Select [Formulation mode]
HOME key  → [Formulation mode] screen → **Go to the recipe list** button →
 Select a recipe → **Edit** button → [Recipe edit] screen

- With the recipe to be edited selected on the [Recipe list] or [Recipe search] screen, pressing the **Edit** button displays the [Recipe edit] screen.







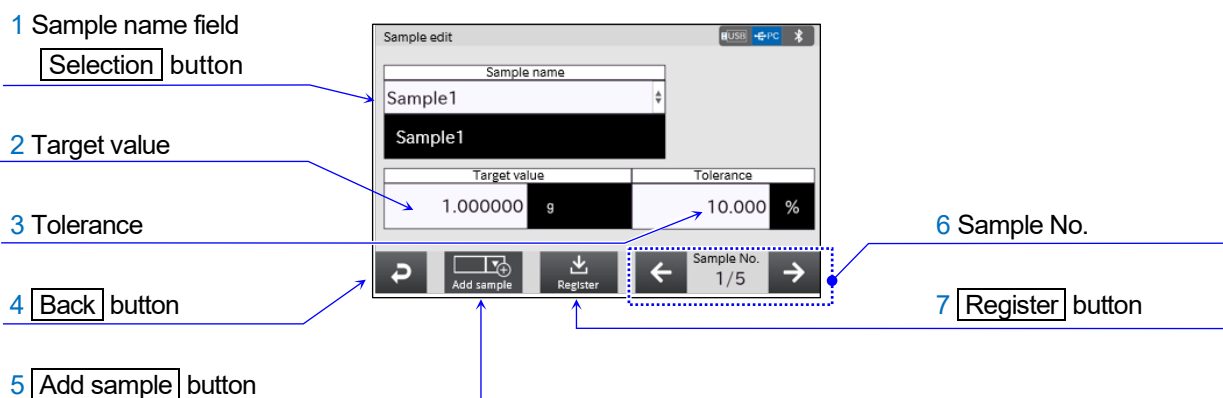

	Name	Description
1	Recipe name	Enter the name of the recipe. Up to 20 characters can be used for the name.
2	Sample registration list	Displays the sample name, target value (g), and tolerance (%) registered in the recipe.
3	Back button	Displays the [Recipe list] screen.
4	Edit button	Displays the [Sample edit] screen. On the [Sample edit] screen, register the sample information in the recipe.
5	Measure button	Displays the [Formulation mode] screen.

5.6.4. Editing a sample



- Display settings: **HOME** key  → **APP** button  → [Application] settings screen
Application selection button → Select [Formulation mode]
HOME key  → [Formulation mode] screen → **Go to the recipe list** button →
 Select the recipe → **Edit** button → **Edit** button → [Sample edit] screen
- Pressing the **Edit** button on the [Recipe edit] screen displays the [Sample edit] screen.



	Name	Setting value (setting range)	Description
1	[Sample name] field, Selection button	—	Select the sample to be registered from the Selection button. Initially this field is blank. You can add samples on the [Sample registration] screen. Details are displayed below the Selection button.
2	Target value	Balance readability ~ Weighing capacity	Set the target value to be weighed for the selected sample.
3	Tolerance	0.001 ~ 100.000	Set the tolerance for the target value to be weighed. Zero cannot be set for the tolerance.
4	Back button	—	Displays the [Recipe edit] screen. The edited contents are discarded and the state before editing is restored.
5	Add sample button	—	Displays the [Sample registration] screen.
6	Sample No.	—	Displays the current sample number. Touching the left arrow  / right arrow  button displays the previous/next page.
7	Register button	—	Registers the edited sample information. The [Recipe edit] screen will be displayed.

- When a sample is selected in the [Sample name] field (1), the input fields for Target value (2) and Tolerance (3) are enabled.
- Pressing the **ON:OFF** key , **HOME** key , **LOG-IN** key , or **MENU** key  displays another screen, discards the edited contents, and restores to the state before editing.

5.6.5. Registering a sample

Display settings: **HOME** key  → **APP** button  → [Application] settings screen
Application selection button → Select [Formulation mode]
HOME key  → [Formulation mode] screen → **Go to the recipe list** button →
 Select the recipe → **Edit** button → **Edit** button → **Add sample** button →
 [Sample registration] screen

- Pressing the **Add sample** button on the [Sample edit] screen displays the [Sample registration] screen.

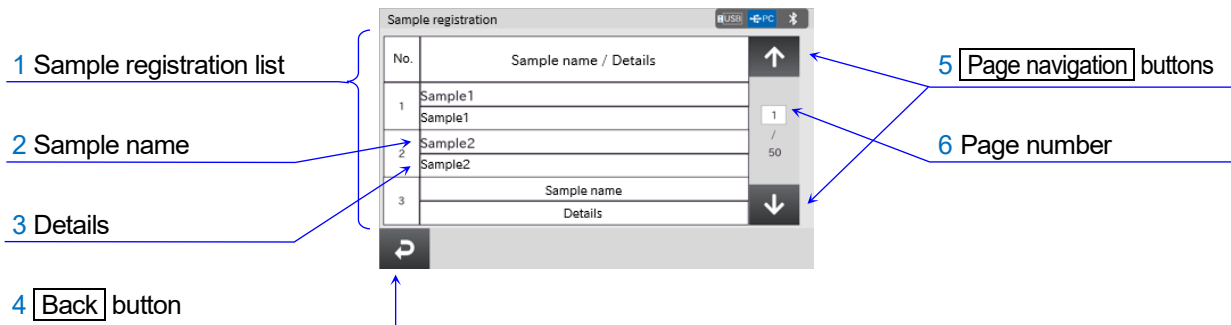



	Name	Description
1	Sample registration list	Displays a list of the registered samples. Up to 150 samples can be registered.
2	Sample name	Enter the sample name to be displayed when you press the Selection button in the [Sample name] field on the [Sample edit] screen. Up to 20 characters can be entered. "Sample name" is displayed in a field where there is no entry.
3	Details	Enter the details that are displayed below the Selection button in the [Sample name] field on the [Sample edit] screen. Up to 30 characters can be entered. "Details" is displayed in a field where there is no entry.
4	Back button	Displays the [Sample edit] screen.
5	Page navigation button	Navigates to the previous/next sample registration list page.
6	Page number	Displays the current page number. To display another page, touch this field and enter the page number.





5.6.6. Sample weighing screen

Display settings: [HOME] key  → [APP] button  → [Application] settings screen

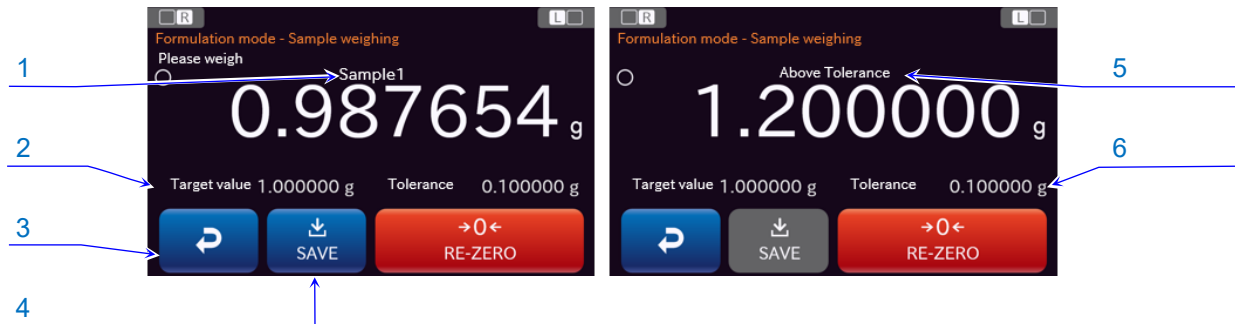
[Application selection] button → Select [Formulation mode]





[HOME] key  → [Formulation mode] screen → [Skip] button  (or [SAVE] button ) → [Formulation mode - Sample weighing] screen





	Name	Description
1	Sample name display	Displays the name of the sample to be weighed.
2	Target value display	Displays the target value of the registered sample.
3	[Back] button	Reweighs the tare of the sample currently being measured. <ul style="list-style-type: none"> □ For the first sample, the [Formulation mode] screen will be displayed. □ For samples other than the first, the [5.6.7. Tare weighing screen] will be displayed.
4	[SAVE] button 	Records the weighing value of the desired sample. <ul style="list-style-type: none"> □ Pressing the [SAVE] button  applies re-zeroing. □ The [SAVE] button  is enabled when the weighing value stabilizes within the allowable range. Allowable range: $(Weighing\ value) - (Target\ value) \leq (Tolerance)$ □ If the next sample is registered in the recipe, pressing the [SAVE] button  displays the [Formulation mode - Tare weighing] screen. □ If it is the last sample, pressing the [SAVE] button  displays the [Formulation mode results] screen.
5	Warning display for weighing value	Displayed with the stability indicator lit when the weighing value is stable while it is out of the allowable range. <ul style="list-style-type: none"> □ If the weighing value exceeds the allowable range, the message [Above tolerance] is displayed. □ If the weighing value is below the allowable range, the message [Below Tolerance] is displayed.
6	Tolerance display	Displays the tolerance for the registered sample. The tolerance is registered as a ratio (%) to the target value and displayed as the value converted to the unit of measure (g).

□ To cancel the measurement, press the [HOME] key .

5.6.7. Tare weighing screen

Display settings: **HOME** key  → **APP** button  → [Application] settings screen
Application selection button → Select [Formulation mode]
HOME key  → [Formulation mode] screen → **SAVE** button  →
 [Formulation mode - Tare weighing] screen



	Name	Description
1	SAVE button 	Weighs the tare value and displays the [Formulation mode - Sample weighing] screen. If the recipe is incomplete, the SAVE button  is disabled. If the weighing value is negative, it is recorded as 0 g.
2	Skip button 	Skips tare weighing and displays the [Formulation mode - Sample weighing] screen. If the recipe is incomplete, the button is disabled.

- If the tare weight plus sample target value exceeds the capacity, the message “Overload error” is displayed for the item indicated by 3 in the figure above and the **SAVE** button  is disabled.

5.6.8. Measurement results screen



Display settings: [HOME] key  → [APP] button  → [Application] settings screen

[Application selection] button → Select [Formulation mode]

[HOME] key  → [Formulation mode] screen → [Skip] button  (or [SAVE] button ) →

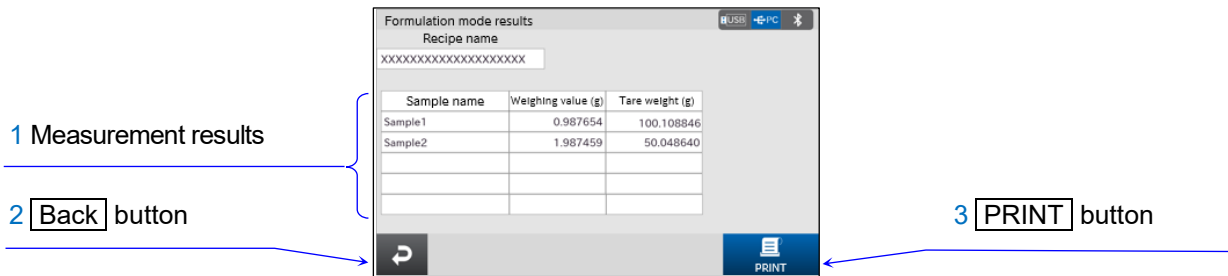
[SAVE] button  → [Formulation mode results] screen



	Name	Description
1	Measurement results	Displays measurement results. If you press the [Skip] button  for a sample, the tare weight field of the sample will be blank. If you press the [Skip] button  for every sample, the tare weight column will not be displayed.
2	[Back] button	Displays the [Formulation mode] screen.
3	[PRINT] button	Outputs the measurement results to a device connected to the balance.

Example of formulation mode results

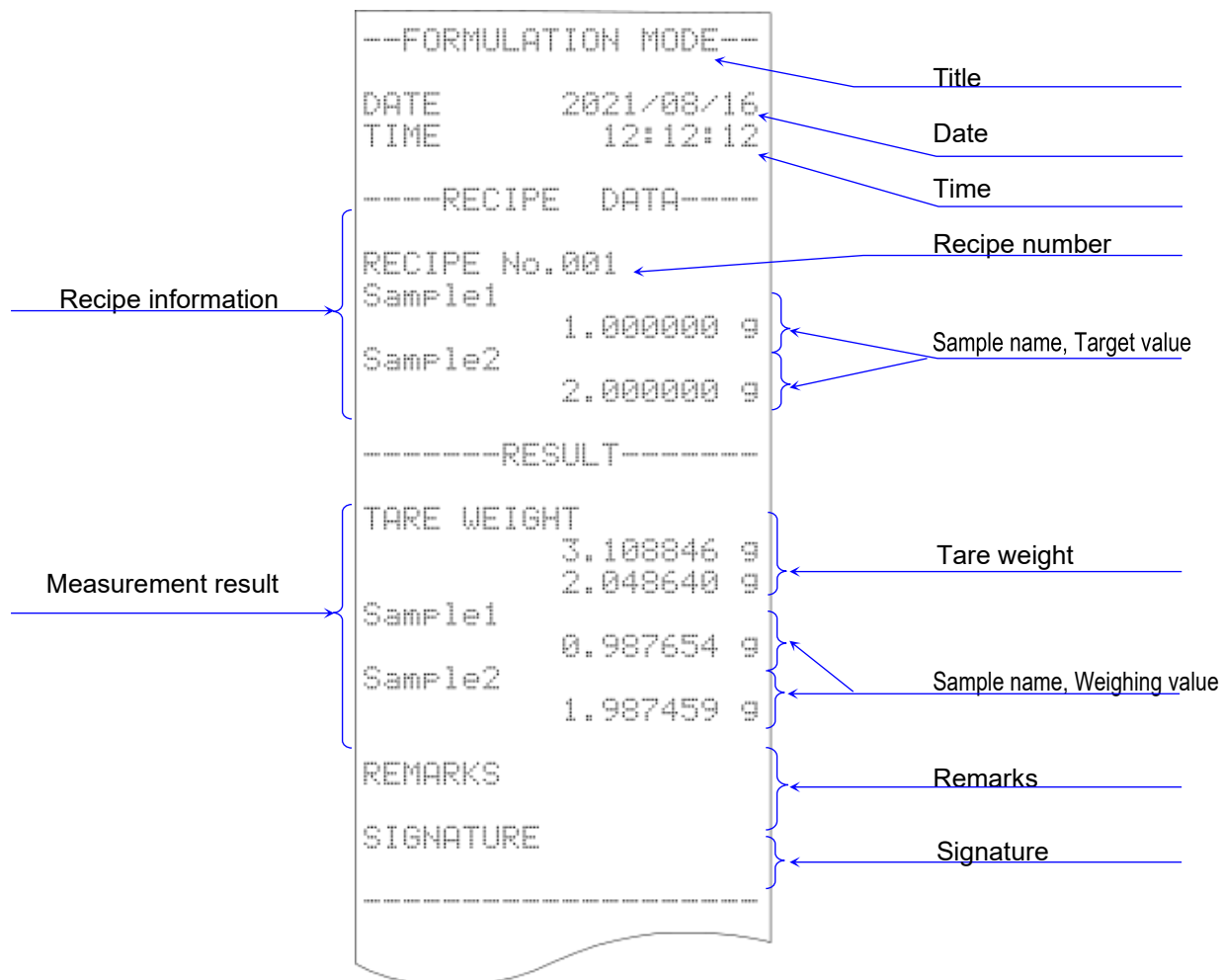

5.6.9. Recipe registration example

The following are used for this recipe registration example.

Recipe name: Test

Samples to be registered:

Sample name	Description	Target value	Tolerance
Sample1	Sample 1	1.000000 g	10.000 %
Sample2	Sample 2	1.000000 g	10.000 %

Step 1 Press the **Go to the recipe list** button on the [Formulation mode] screen to display the [Recipe list] screen.

Press the **Go to the recipe list** button

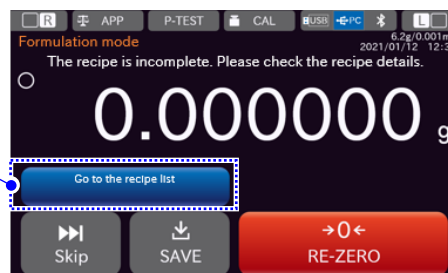

Step 2. On the [Recipe list] screen, touch and select the line with the number to which the recipe will be registered. In the example, the first line is selected for registration. After selecting the recipe to be registered, press the **Edit** button to display the [Recipe edit] screen in step 3.

Press the **Edit** button

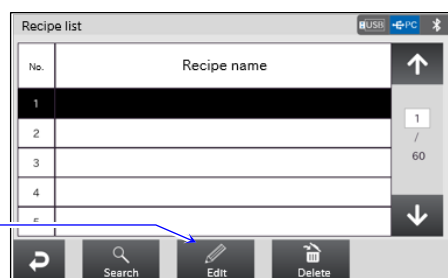

Step 3. Enter the recipe name. In the example, the recipe name is set to "Test". After inputting, press the **Edit** button to display the [Sample edit] screen in step 4.

Enter the recipe name

Press the **Edit** button

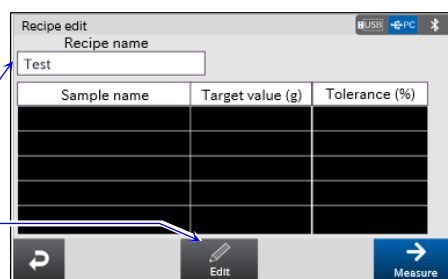

Step 4. Select the sample to be registered using the **Selection** button in the [Sample name] field.

Initially, the [Sample name] field is blank. When using the formulation mode for the first time, add samples to the **Selection** button. To add a sample, press the **Add sample** button to display the [Sample registration] screen in step 5.

If you have samples already registered, proceed to step 6.

Selection button in the [Sample name] field

Press the **Add sample** button

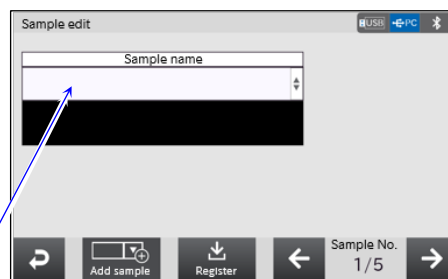

Step 5. Enter the [Sample name] and [Details] to be registered. The figure on the right shows an input example on the [Sample registration] screen. After inputting, press the **Back** button to display the [Sample edit] screen.

Enter the fields then press the **Back** button

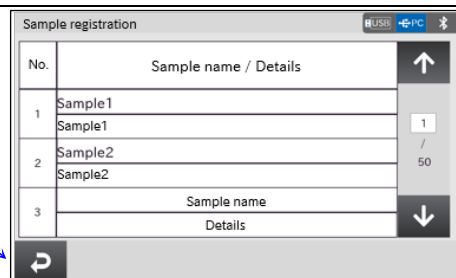

Step 6. Register the first sample in the recipe. Select the desired sample using the **Selection** button, and then enter values in the [Target value] and [Tolerance] fields. In the example, the sample name is Sample1, the target value is 1.000000 g, and the tolerance is 10.000%. After inputting, press the right arrow button **→** at the bottom right of the screen to display the registration screen for the second sample.

The right arrow button **→** displays the registration screen for the next sample.

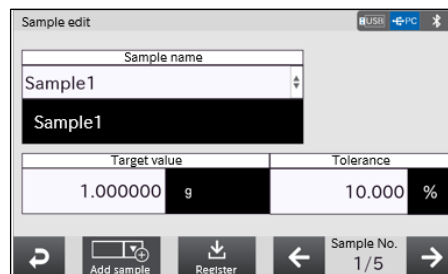

Step 7. Register the second sample in the recipe. Enter values in the [Target value] and [Tolerance] fields. Then, press the **Register** button to register the recipe and display the [Recipe edit] screen.

In the example, the sample name is Sample2, the target value is 1.000000 g, and the tolerance is 10.000%.

Press the **Register** button

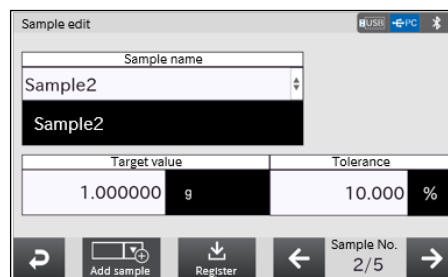

Caution

If the **Back** button, **ON:OFF** key (ON/OFF), **HOME** key (HOME), **LOG-IN** key (LOG-IN), or **MENU** key (MENU) is pressed to display another screen, the sample is not registered in the recipe.

Step 8. Now the recipe registration is complete. To start measurement with the registered recipe, press the **Measure** button on the [Recipe edit] screen.

To register another recipe, press the **Back** button on the [Recipe edit] screen to display the [Recipe list] screen, and then repeat from Step 2 to register the recipe.

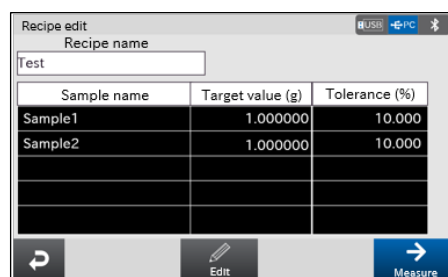

5.6.10. Measurement example

Select a recipe to perform measurement according to the recipe. The registration example below is described here as an example.

Recipe name: Test

Samples to be registered:

Sample name	Description	Target value	Tolerance
Sample1	Sample 1	1.000000 g	10.000 %
Sample2	Sample 2	1.000000 g	10.000 %

Step 1. On the [Formulation mode] screen, press the **Go to the recipe list** button to display the [Recipe list] screen.

Select the recipe to be used for the measurement from the list and press the **Back** button to display the [Formulation mode] screen.

Re-zero will be applied automatically when the screen changes to the [Formulation mode] screen.

Sample 1 is selected here as an example.

Step 2. To record the tare value:

Press the **SAVE** button  when the weighing value is 0 g or greater and stable.

Tare operation will be applied automatically when the **SAVE** button  is pressed.

The weighing screen for the first sample is displayed.

If the target value plus tare value of the first sample exceeds the capacity, the **SAVE** button  is disabled.

To skip recording of the tare value:

Press the **Skip** button .

The weighing screen for the first sample is displayed.

If a warning is displayed at the top of the screen:

Check the recipe name or the target value and tolerance value of the registered sample.

Step 3. Weigh the displayed sample.

When the stability indicator lights up and the **SAVE** button  is enabled, press the button to save the weighing value.

Allowable range: $|(Weighing\ value) - (Target\ value)| \leq (Tolerance)$

If the allowable range is exceeded:

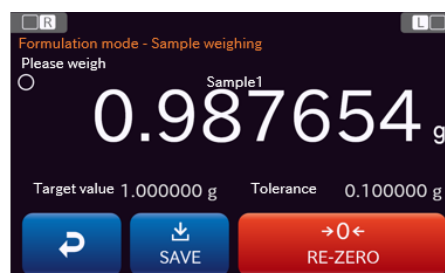

To start over from tare weighing with the current sample, press the **Back** button.



Step 4. Repeat the tare weighing and sample weighing in steps 2 and 3 for every sample registered in the recipe.

Step 5. The measurement results screen will be displayed when measurement of all samples is completed. Check and output the results. Then, press the **Back** button to display the [Formulation mode] screen.

5.6.11. Exporting/importing recipes (with the touch panel software version 1.019 or later)

Display settings: HOME key  → [Formulation mode] screen → Go to the recipe list button → USB flash drive button  → [Export/import recipe] screen

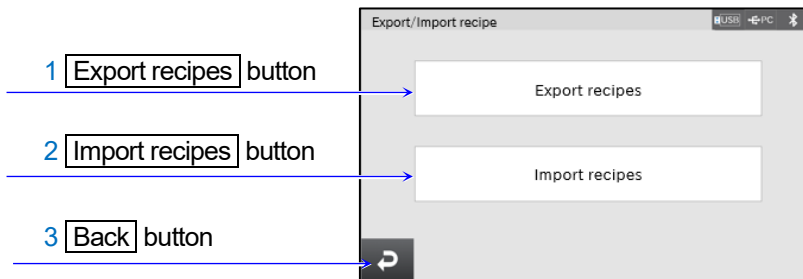

	Name	Description
1	Export recipes button	Exports recipes that are registered in the USB flash drive.
2	Import recipes button	Imports recipes from the USB flash drive.
3	Back button	Returns to the previous screen.

- The name of the exported file is 'ExportedRecipe_Formulation.'
- When recipes are imported, an error message will be displayed if there is no file mentioned above in the USB flash drive or the contents of the file is wrong.
- Recipes cannot be imported to models that have a different weighing capacity.



5.7. HPLC function

HPLC function usage





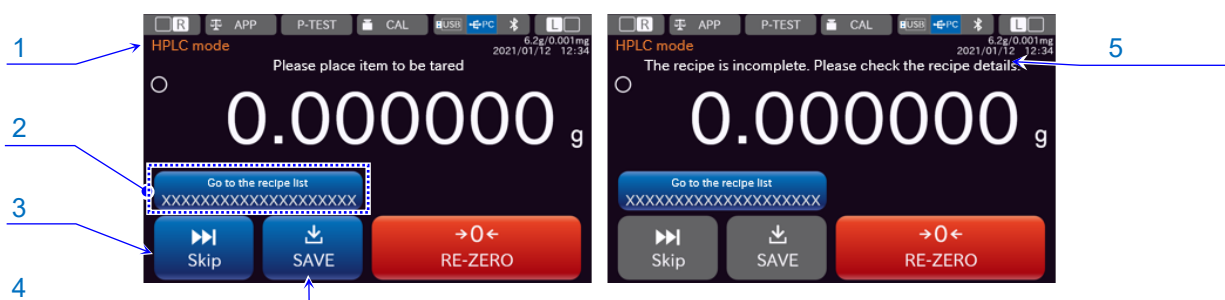

- The HPLC function allows you to register in the recipe the sample to be weighed and the molarity (mol/L, mmol/L) or the target value in unit of mass (g) and the tolerance for the target value, and to perform weighing according to the recipe.
- The target value (g) of the sample is calculated by the following formula.
Target value (g) = Molarity (mol/L) x Solution volume (L) x Molecular weight

Caution

- Initializing the balance clears the sample contents and registered recipes (excluding those registered at the time of shipment from the factory).
- If you configure this display, the **HOME** screen changes to If you configure this display, the HOME screen changes to HPLC mode.



Display settings: **HOME** key  → **APP** button  → [Application] settings screen
Application selection button → Select [HPLC mode]
HOME key  → [HPLC mode] screen



	Name	Description
1	HPLC mode	Displayed when in the HPLC mode.
2	Got to the recipe list button	Displays the [Recipe list]. Also displays the name of the currently selected recipe.
3	Skip button 	Skips tare weighing and displays the [HPLC mode - Sample weighing] screen. If the recipe is incomplete, the button is disabled.
4	SAVE button 	Weighs the tare value and displays the [HPLC mode - Sample weighing] screen. If the recipe is incomplete, the SAVE button  is disabled. If the weighing value is negative, it is recorded as 0 g.
5	Display indicating that the recipe is incomplete	If the selected recipe is incomplete: The message “The recipe is incomplete. Please check the recipe details.” is displayed and the Skip button  and SAVE button  are disabled. Check the recipe name and the target value and tolerance of the sample registered in the recipe. If the selected recipe is complete: The message “Please place item to be tared” is displayed and the Skip button  and SAVE button  are enabled.

- This is the screen for [HPLC mode]. This mode can be used only with the unit “g”.
- Re-zero will be applied automatically when the screen changes to [HPLC mode].
- If the tare weight plus sample target value exceeds the capacity, the message “Overload error” is displayed for the item indicated by 5 in the figure above and the **SAVE** button  is disabled.

5.7.1. Selecting a recipe

Display settings: [HOME] key  → [APP] button  → [Application] settings screen
 [Application selection] button → Select [HPLC mode]
 [HOME] key  → [HPLC mode] screen → [Go to the recipe list] button →
 [Recipe list] screen

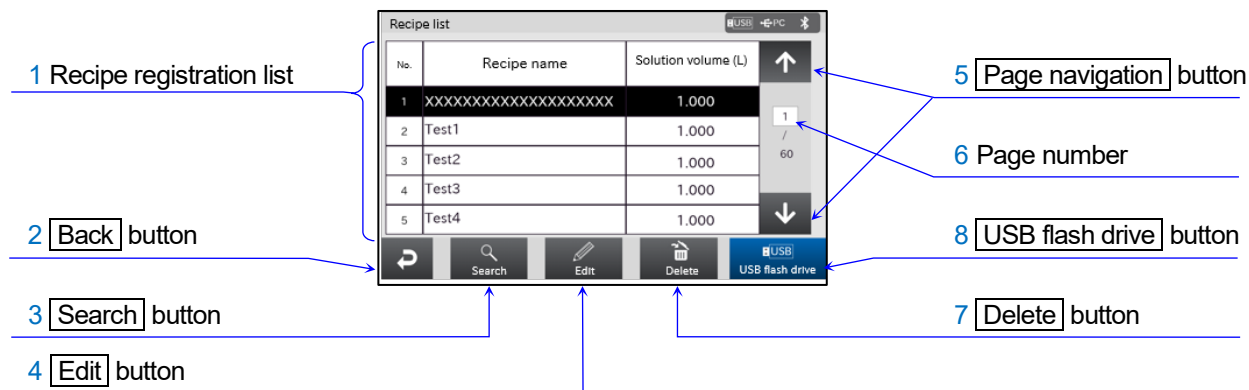



	Name	Description
1	Recipe registration list	Displays the list of registered recipes. Touch a recipe to select. The selected recipe is highlighted in black.
2	[Back] button	Displays the [HPLC mode] screen.
3	[Search] button	Displays the [Recipe search] screen.
4	[Edit] button	Displays the [Recipe edit] screen.
5	[Page navigation] button	Navigates the previous/next recipe registration list page.
6	Page number	Displays the current page number. To display another page, touch this field and enter the page number.
7	[Delete] button	Deletes the selected recipe.
8	[USB flash drive] button	Displays the [Export/import recipe] screen.*

- Up to 300 recipes can be registered in total.
- If you have many recipes registered and it is difficult to find one from the list, the recipe search function will come in useful.

* Supported with the touch panel software version 1.019 or later

5.7.2. Searching a recipe

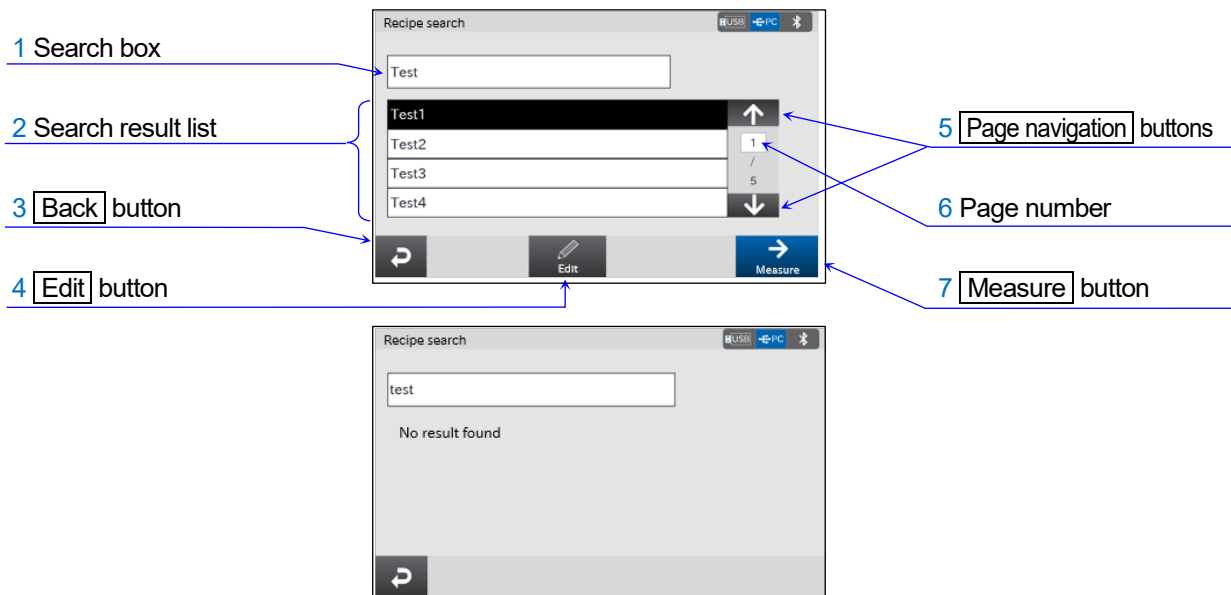

Display settings: [HOME] key  → [APP] button  → [Application] settings screen
 [Application selection] button → Select [HPLC mode]
 [HOME] key  → [HPLC mode] screen → [Go to the recipe list] button →
 [Search] button → [Recipe search] screen



	Name	Description
1	Search box	Enter the search term. The search method is prefix search. If there is no search result, the message “No result found” is displayed.
2	Search result list	Displays the list of search results. Touch a recipe to select. The selected recipe is highlighted in black.
3	[Back] button	Displays the [Recipe list] screen.
4	[Edit] button	Displays the [Recipe edit] screen. Edit the contents of the selected recipe.
5	[Page navigation] button	Navigates to the previous/next search result page.
6	Page number	Displays the current page number. To display another page, touch this field and enter the page number.
7	[Measure] button	Displays the [HPLC mode] screen and starts measuring with the selected recipe.

□ The [Edit] button and [Measure] button only appear when the search results are displayed.

5.7.3. Editing a recipe

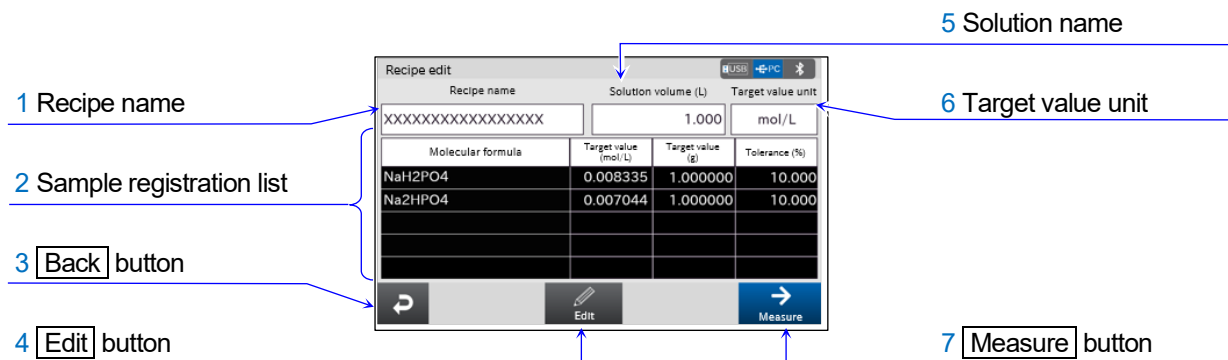

Display settings: **HOME** key  → **APP** button  → [Application] settings screen
Application selection button → Select [HPLC mode]
HOME key  → [HPLC mode] screen → **Go to the recipe list** button →
 Select a recipe → **Edit** button → [Recipe edit] screen

- With the recipe to be edited selected on the [Recipe list] or [Recipe search] screen, pressing the **Edit** button displays the [Recipe edit] screen.





	Name	Description
1	Recipe name	Enter the name of the recipe. Up to 20 characters can be used for the name.
2	Sample registration list	Displays the molecular formula, target molarity (mol/L or mmol/L), target value (g), and tolerance (%) registered in the recipe.
3	Back button	Displays the [Recipe list] screen.
4	Edit button	Displays the [Sample edit] screen. On the [Sample edit] screen, register the sample information in the recipe.
5	Solution name	Enter the volume of the solution to make.
6	Target value unit	Set the unit of the target value to be entered on the [Sample edit] screen. The unit can be selected from mol/L, mmol/L, and g.
7	Measure button	Displays the [HPLC mode] screen.

5.7.4. Editing a sample

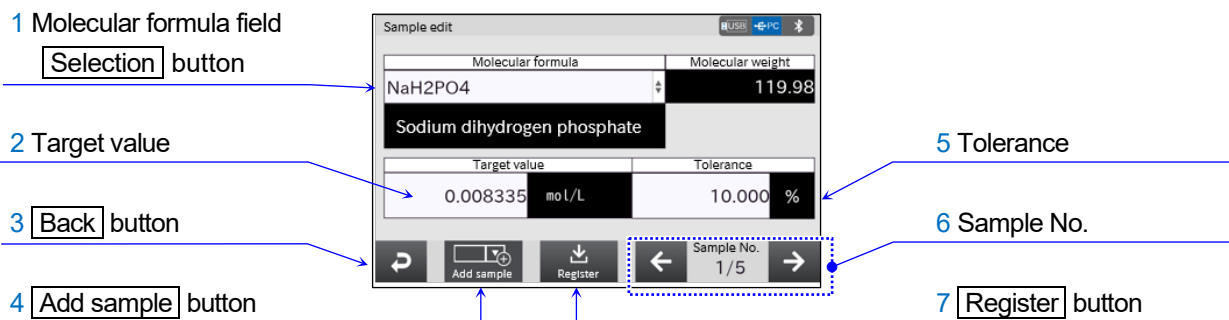
- Display settings: [HOME] key  → [APP] button  → [Application] settings screen
 [Application selection] button → Select [HPLC mode]
 [HOME] key  → [HPLC mode] screen → [Go to the recipe list] button →
 Select the recipe → [Edit] button → [Edit] button → [Sample edit] screen
 Pressing the [Edit] button on the [Recipe edit] screen displays the [Sample edit] screen.





	Name	Setting value (setting range)	Description
1	[Molecular formula] field, [Selection] button	—	Select the sample to be registered from the [Selection] button. Initially this field is blank. You can add samples on the [Sample registration] screen. Sample names are displayed below the [Selection] button.
2	Target value	Balance readability ~ Weighing capacity	Set the target value to be weighed for the selected sample.
3	[Back] button	—	Displays the [Recipe edit] screen. The edited contents are discarded and the state before editing is restored.
4	[Add sample] button	—	Displays the [Sample registration] screen.
5	Tolerance	0.001 ~ 100.000	Set the tolerance for the target value to be weighed. Zero cannot be set for the tolerance.
6	Sample No.	—	Displays the current sample number. Touching the left arrow  / right arrow  button displays the previous/next page.
7	[Register] button	—	Registers the edited sample information. The [Recipe edit] screen will be displayed.

- When a sample is selected in the [Sample name] field (1), the input fields for Target value (2) and Tolerance (5) are enabled.
- The following samples are registered for the [Selection] button at the time of shipment from the factory.

Display in the [Molecular formula] field	Sample name	Molecular weight
NaH ₂ PO ₄	Sodium dihydrogen phosphate	119.98
Na ₂ HPO ₄	Disodium hydrogen phosphate	141.96
KH ₂ OP ₄	Potassium dihydrogen phosphate	136.09
K ₂ HOP ₄	Dipotassium hydrogen phosphate	174.18
C ₆ H ₈ O ₇ ·H ₂ O	Citric acid hydrate	210.14
C ₆ H ₅ Na ₃ O ₇ ·2H ₂ O	Trisodium citrate dihydrate	294.10
CH ₃ COONa	Sodium acetate	82.03
CH ₃ COONH ₄	Ammonium acetate	77.08
HCOONH ₄	Ammonium formate	63.06
C ₄ H ₄ Na ₂ O ₆ ·2H ₂ O	Sodium tartrate dihydrate	230.08
H ₃ BO ₄	Boric acid	61.83
NaClO ₄	Sodium perchlorate	122.44
NaCl	Sodium chloride	58.44

5.7.5. Registering a sample

Display settings: [HOME] key  → [APP] button  → [Application] settings screen
 [Application selection] button → Select [HPLC mode]
 [HOME] key  → [HPLC mode] screen → [Go to the recipe list] button →
 Select the recipe → [Edit] button → [Edit] button → [Add sample] button →
 [Sample registration] screen

- Pressing the [Add sample] button on the [Sample edit] screen displays the [Sample registration] screen.

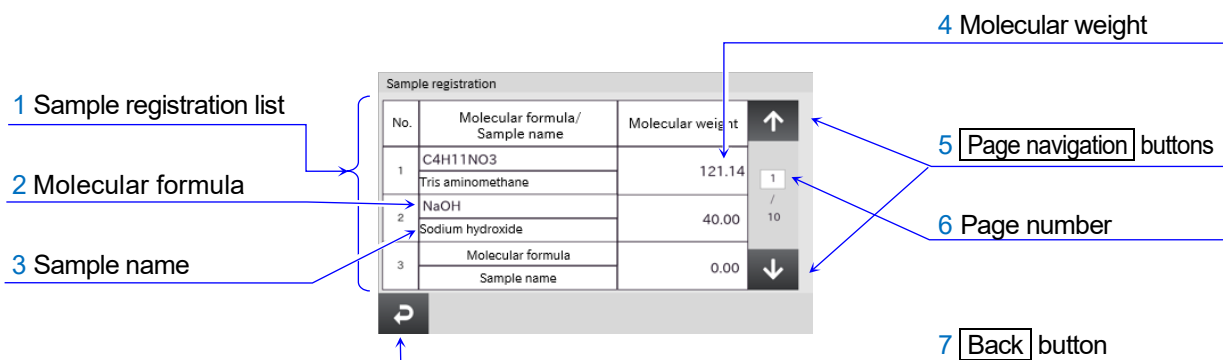

	Name	Description
1	Sample registration list	Displays a list of the registered samples. In addition to the 13 samples initially registered, 30 samples can be registered.
2	Molecular formula	Enter the sample name to be displayed when you press the [Selection] button in the [Molecular formula] field on the [Sample edit] screen. Up to 20 characters can be entered. “Molecular formula” is displayed in the field where there is no entry.
3	Sample name	Enter the sample name to be displayed below the [Selection] button in the [Sample name] field on the [Sample edit] screen. Up to 30 characters can be entered. “Sample name” is displayed in a field where there is no entry.
4	Molecular weight	Enter the molecular weight of the sample to be registered.※1
5	[Page navigation] button	Navigates to the previous/next sample registration list page.
6	Page number	Displays the current page number. To display another page, touch this field and enter the page number.
7	[Back] button	Displays the [Sample edit] screen.





※1 When the sample is not registered in the recipe:

The input range for the molecular weight of the sample is 0.00 to 9999999.99.





When the sample is already registered in the recipe:

The molecular weight can be entered in the range in which the amount to be weighed does not exceed the capacity of the balance

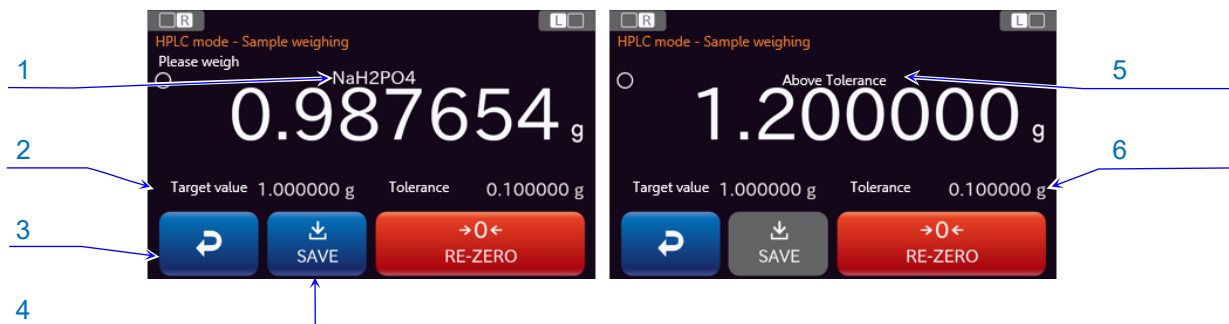
5.7.6. Sample weighing screen

Display settings: **HOME** key  → **APP** button  → [Application] settings screen
Application selection button → Select [HPLC mode]
HOME key  → [HPLC mode] screen → **Skip** button  (or **SAVE** button ) →
[HPLC mode - Sample weighing] screen



	Name	Description
1	Sample name display	Displays the name of the sample to be weighed.
2	Target value display	Displays the target value of the registered sample.
3	Back button	Reweighs the tare of the sample currently being measured. <ul style="list-style-type: none"> For the first sample, the [HPLC mode] screen will be displayed. For samples other than the first, the [HPLC mode - Tare weighing] screen will be displayed.
4	SAVE button 	Records the weighing value of the desired sample. <ul style="list-style-type: none"> Pressing the SAVE button  applies re-zeroing. The SAVE button  is enabled when the weighing value stabilizes within the allowable range. Allowable range: $(Weighing\ value) - (Target\ value) \leq (Tolerance)$ If the next sample is registered in the recipe, pressing the SAVE button  displays the [HPLC mode - Tare weighing] screen. If it is the last sample, pressing the SAVE button  displays the [HPLC mode results] screen.
5	Warning display for weighing value	Displayed with the stability indicator lit when the weighing value is stable while it is out of the allowable range. <ul style="list-style-type: none"> If the weighing value exceeds the allowable range, the message [Above tolerance] is displayed. If the weighing value is below the allowable range, the message [Below Tolerance] is displayed.
6	Tolerance display	Displays the tolerance for the registered sample. The tolerance is registered as a ratio (%) to the target value and displayed as the value converted to the unit of measure (g).

□ To cancel the measurement, press the **HOME** key .

5.7.7. Tare weighing screen

Display settings: **HOME** key → **APP** button → [Application] settings screen
 [Application selection] button → Select [HPLC mode]
HOME key → [HPLC mode] screen → **SAVE** button →
 [HPLC mode - Tare weighing] screen

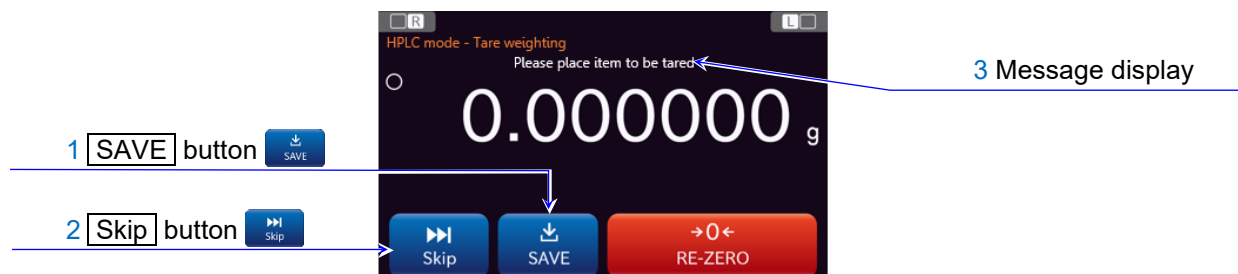

	Name	Description
1	SAVE button	Weighs the tare value and displays the [HPLC mode - Sample weighing] screen. If the recipe is incomplete, the SAVE button is disabled. If the weighing value is negative, it is recorded as 0 g.
2	Skip button	Skips tare weighing and displays the [HPLC mode - Sample weighing] screen. If the recipe is incomplete, the button is disabled.

- If the tare weight plus sample target value exceeds the capacity, the message “Overload error” is displayed for the item indicated by 3 in the figure above and the **SAVE** button is disabled.

5.7.8. Measurement results screen

Display settings: **HOME** key → **APP** button → [Application] settings screen
 [Application selection] button → Select [HPLC mode]
HOME key → [HPLC mode] screen → **Skip** button (or **SAVE** button) →
SAVE button → [HPLC mode results] screen

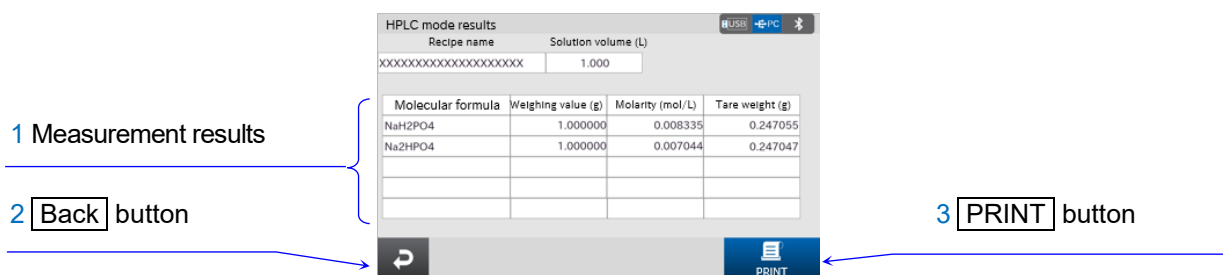

	Name	Description
1	Measurement results	Displays measurement results. If you press the Skip button for a sample, the tare weight field of the sample will be blank. If you press the Skip button for every sample, the tare weight column will not be displayed.
2	Back button	Displays the [HPLC mode] screen.
3	PRINT button	Outputs the measurement results to a device connected to the balance.

Example of HPLC mode results

```
-----HPLC  MODE-----
DATE      2021/08/16
TIME      12:12:12

-----RECIPE  DATA-----
RECIPE No.001
SOLUTION VOLUME
          1.000 L
NaH2PO4   1.000000 g
Na2HPO4   1.000000 g

-----RESULT-----
TARE WEIGHT
          3.108846 g
          2.048640 g
NaH2PO4   0.945216 g
          0.007878 mol/L
Na2HPO4   0.983151 g
          0.000693 mol/L

REMARKS

SIGNATURE
```

Recipe information

- Recipe number
- Solution volume
- Molecular formula, Target value

Measurement result

- Tare weight
- Molecular formula, Weighing value, Molarity
- Remarks
- Signature

5.7.9. Recipe registration example

The following are used for this recipe registration example.

Recipe name	PBS(-)
Target value unit	mmol/L
Solution volume	1 L

Sample name	Target value	Tolerance
Disodium hydrogen phosphate	10.000 mmol/L	10.000 %
Potassium dihydrogen phosphate	2.000 mmol/L	10.000 %
Sodium chloride	137.000 mmol/L	10.000 %
Potassium chloride	2.680 mmol/L	10.000 %

Step 1. Press the **Go to the recipe list** button on the [HPLC mode] screen to display the [Recipe list] screen.

Press the **Go to the recipe list** button

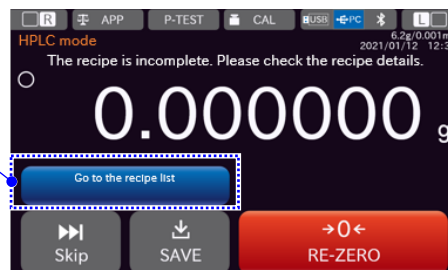

Step 2. On the [Recipe list] screen, touch and select the line with the number to which the recipe will be registered. In the example, the first line is selected for registration. After selecting the recipe to be registered, press the **Edit** button to display the [Recipe edit] screen in step 3.

Press the **Edit** button

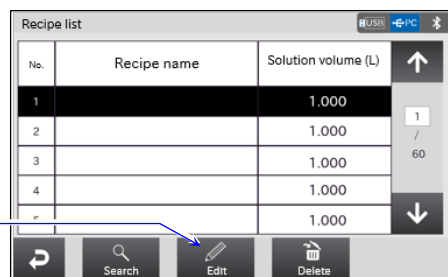

Step 3. Enter the recipe name. In the example, the recipe name is set to "PBS (-)", the buffer volume is set to 1.000 L, and the target value unit is set to mmol/L. After setting, press the **Edit** button to display the [Sample edit] screen in step 4.

Enter the recipe name

Enter the solution volume

Specify the target value unit

Press the **Edit** button

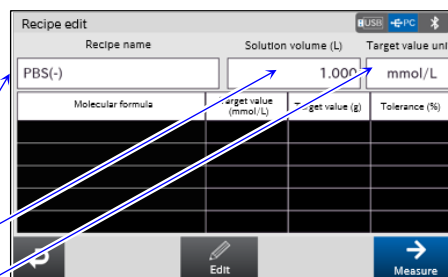

Step 4. Select the sample to be registered using the **Selection** button in the [Molecular formula] field. To select a sample other than the one registered at the time of shipment from the factory, the sample needs to be added to the **Selection** button. In this case, press the **Add sample** button to go to the [Sample registration] screen in step 5. In this example, potassium chloride is newly registered. Press the **Add sample** button to go to step 5.

If a sample does not need to be added, proceed to step 6.

Selection button in the [Molecular formula] field

Press the **Add sample** button

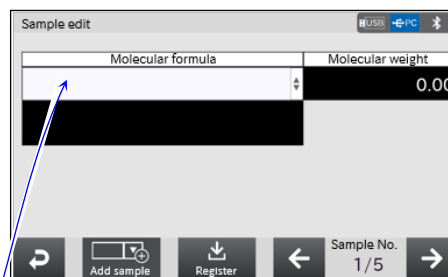

Step 5. Enter the [Molecular formula] and [Sample name] to be registered. The figure on the right shows an input example on the [Sample registration] screen. After inputting, press the **Back** button to display the [Sample edit] screen.

Enter the fields then press the **Back** button

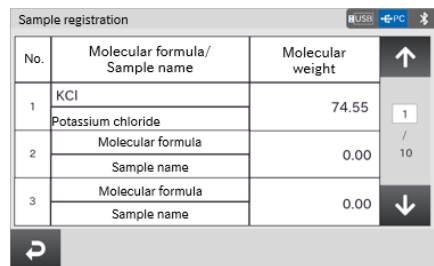



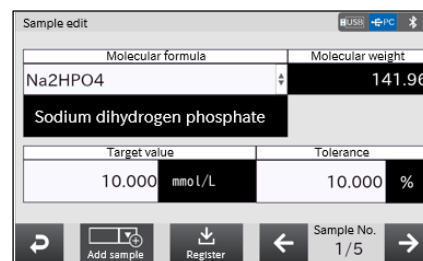

Step 6. Register the first sample in the recipe. Select the desired sample using the **Selection** button, and then enter values in the [Target value] and [Tolerance] fields. In the example, the sample name is Na₂HPO₄, the target value is 10.000 mmol/L, and the tolerance is 10.000 %. After inputting, press the right arrow button **→** at the bottom right of the screen to display the registration screen for the second sample.

The right arrow button **→** displays the registration screen for the next sample.



Step 7. Enter the contents of the remaining samples in the same way. Then, press the **Register** button to register the recipe and to display the [Recipe edit] screen.

Caution: If the **Back** button, **ON:OFF** key , **HOME** key , **LOG-IN** key , or **MENU** key  is pressed to display another screen, the sample is not registered in the recipe.

Press the **Register** button

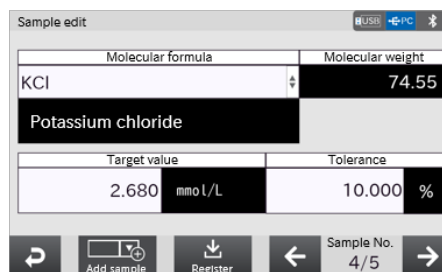

Step 8. Now the recipe registration is complete.

To start measurement with the registered recipe, press the **Measure** button on the [Recipe edit] screen.

To register another recipe, press the **Back** button on the [Recipe edit] screen to display the [Recipe list] screen, and then register the recipe on the [Recipe list] screen shown in step 2.





5.7.10. Measurement example

Select a recipe to perform measurement according to the recipe. The registration example below is described here as an example.

Recipe name	PBS(-)
Target value unit	mmol/L
Solution volume	1 L

Sample name	Target value	Tolerance
Disodium hydrogen phosphate	10.000 mmol/L	10.000 %
Potassium dihydrogen phosphate	2.000 mmol/L	10.000 %
Sodium chloride	137.000 mmol/L	10.000 %
Potassium chloride	2.680 mmol/L	10.000 %

Step 1. On the [HPLC mode] screen, press the **Go to the recipe list** button to display the [Recipe list] screen. Select the recipe to be used for the measurement from the list and press the **Back** button to display the [HPLC mode] screen.
Re-zero will be applied automatically when the screen changes to the [HPLC mode] screen.
Sample 1 is selected here as an example.

Step 2. To record the tare value:
Press the **SAVE** button  when the weighing value is 0 g or greater and stable.
Tare operation will be applied automatically when the **SAVE** button  is pressed.
The weighing screen for the first sample is displayed.
If the target value plus tare value of the first sample exceeds the capacity, the **SAVE** button  is disabled.

To skip recording of the tare value:

Press the **Skip** button .

The weighing screen for the first sample is displayed.

If a warning is displayed at the top of the screen:

Check the recipe name or the target value and tolerance value of the registered sample.

Step 3. Weigh the displayed sample.

When the stability indicator lights up and the **SAVE** button  is enabled, press the button to save the weighing value.

Allowable range: $|(Weighing\ value) - (Target\ value)| \leq (Tolerance)$

If the allowable range is exceeded:

To start over from tare weighing with the current sample, press the **Back** button.



Step 4. Repeat the tare weighing and sample weighing in steps 2 and 3 for every sample registered in the recipe.

Step 5. The measurement results screen will be displayed when measurement of all samples is completed. Check and output the results. Then, press the **Back** button to display the [HPLC mode] screen.

5.7.11. Exporting/importing recipes (with the touch panel software version 1.019 or later)

Display settings: **HOME** key  → [HPLC mode] screen → **Go to the recipe list** button → **USB flash drive** button  → [Export/import recipe] screen

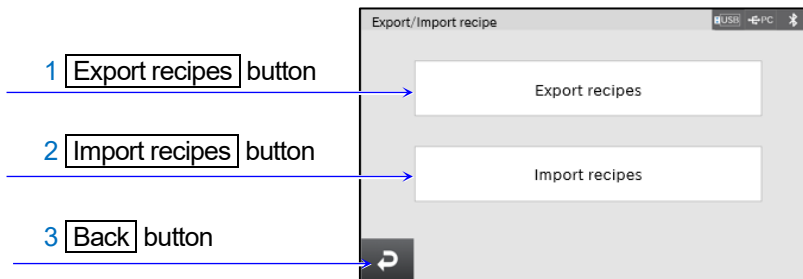

	Name	Description
1	Export recipes button	Exports recipes that are registered in the USB flash drive.
2	Import recipes button	Imports recipes from the USB flash drive.
3	Back button	Returns to the previous screen.

- The name of the exported file is 'ExportedRecipe_HPLC.'
- When recipes are imported, an error message will be displayed if there is no file mentioned above in the USB flash drive or the contents of the file is wrong.
- Recipes cannot be imported to models that have a different weighing capacity.

5.8. Statistical calculation function

Usage

- This mode processes weighing values statistically and displays/outputs the result.
- Calculation items available for display/output include the number of data, sum, maximum, minimum, range (Max-Min), mean, standard deviation, coefficient of variation and relative error. You can select these output data in four steps on the [Statistical calculation setting] screen.
- You can delete incorrectly input data from the [Statistical calculation results] screen.
- Statistical results are initialized if the statistical calculation function is disabled or the power is turned off.
- The standard deviation, coefficient of variation and relative error are calculated with the following formulas.



$$\text{Standard deviation} = \sqrt{\frac{N \cdot \sum(X_i)^2 - (\sum X_i)^2}{N \cdot (N - 1)}} \quad \text{Where } X_i \text{ is the } i\text{th weighing value and } N \text{ is the number of data.}$$

$$\text{Coefficient of variation (CV)} = \frac{\text{Standard deviation}}{\text{Mean}} \cdot 100 (\%)$$

$$\text{Relative error of the maximum value (MAX\%)} = \frac{\text{Maximum} - \text{Mean}}{\text{Mean}} \cdot 100 (\%)$$

$$\text{Relative error of the minimum value (MIN\%)} = \frac{\text{Minimum} - \text{Mean}}{\text{Mean}} \cdot 100 (\%)$$

- If the minimum display digit is disabled for any data, the calculation result is displayed with the minimum display digit disabled.
(The minimum display digit is rounded off)
- If the statistical calculation function is enabled, you cannot change the application, unit of measure or readability.
- If you configure this display, the HOME screen changes to the weighing screen with the statistical calculation function.

Display settings: [HOME] key  → [APP] button  APP → [Application] settings screen
 [Statistical calculation function] button → Select [ON].

[HOME] key  → Weighing screen with the statistical calculation function

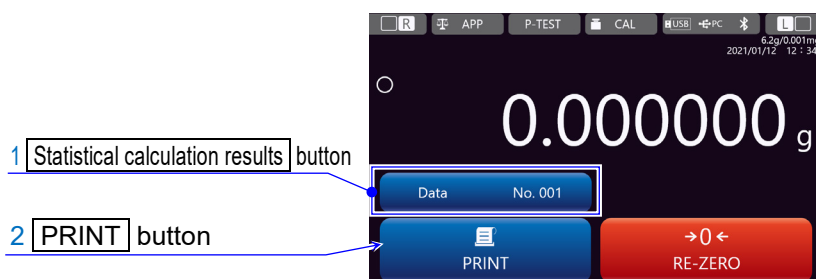

	Name	Description
1	[Statistical calculation results] button	Displays the [Statistical calculation results] screen. Also displays the number of input data. The number of data is displayed within the range from 000 to 999.
2	[PRINT] button	Adds data to be used for statistical calculation. Also outputs data to the device connected to the balance.

- This is the screen for the statistical calculation function.

5.8.1. Statistical calculation results

Display settings for statistical calculation results

Display settings: **HOME** key  → **APP** button  → [Application] settings screen

Statistical calculation function button → Select [ON].

HOME key  → Weighing screen with the statistical calculation function →

Statistical calculation results button

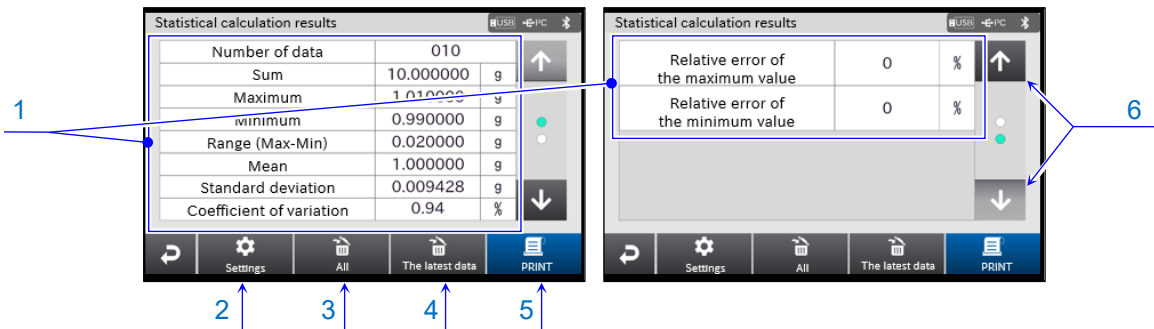

	Name	Description
1	Statistical calculation results area	Displays the statistical calculation results.
2	Statistical calculation setting button	Displays the [Statistical calculation setting] screen.
3	Delete all button	Deletes all statistical calculation data.
4	Delete latest data button	Deletes the latest statistical calculation data.
5	PRINT button	Outputs the statistical calculation results to the device connected to the balance.
6	Page navigation button	Navigates to the previous/next statistical calculation results page.

□ This is the screen for the statistical calculation results.

Display settings for the statistical calculation setting

Display settings: [HOME] key  → [APP] button  APP → [Application] settings screen

→ [Statistical calculation function] button → Select [ON].

[HOME] key  → Weighing screen with the statistical calculation function

→ [Statistical calculation results] button → [Statistical calculation setting] button

1 Statistical display output

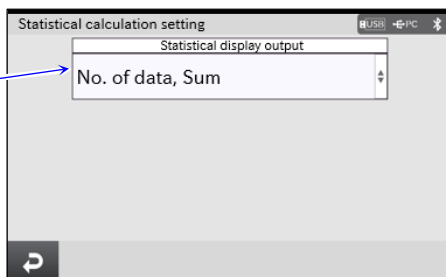

	Name	Setting value	Description
1	Statistical display output	<ul style="list-style-type: none"> • No. of data, Sum • No. of data, Sum, Max, Min, Range, Mean • No. of data, Sum, Max, Min, Range, Mean, SD, CV • No. of data, Sum, Max, Min, Range, Mean, SD, CV, Relative error 	Selects the display/output for statistical calculation results.

 Settings in the red box are default values (factory settings).

□ This is the screen for selecting the statistical calculation display.

5.8.2. Statistical calculation output example

Registering data

Step Press the **PRINT** button  in the weighing screen.

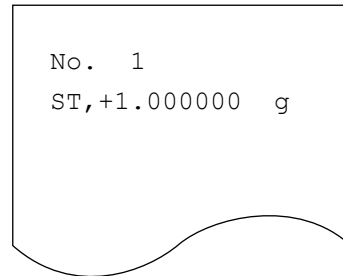
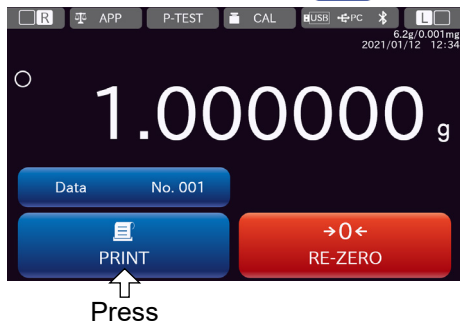

Outputting results

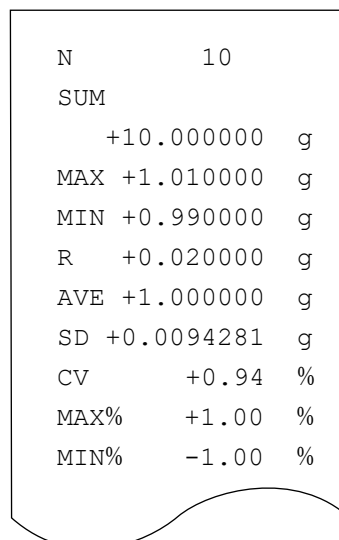
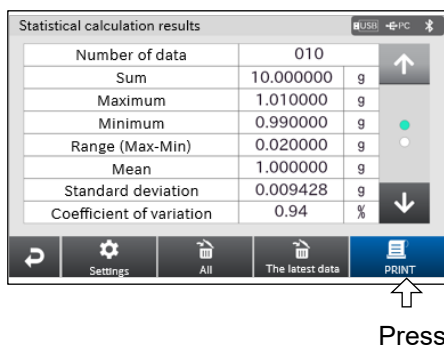

Step Press the **PRINT** button  in the [Statistical calculation results] screen.

Statistical display output: Number of data, Sum, Maximum, Minimum, Range, Mean, Standard deviation, Coefficient of variation, Relative error



5.9. Capacity indicator

- If you configure this display, the HOME screen changes to the weighing screen with the capacity indicator.

Display settings: **HOME** key  → **APP** button  → [Application] settings screen
Capacity indicator button → Select [ON].
HOME key  → Weighing screen with the capacity indicator







1 Capacity indicator





	Name	Description
1	Capacity indicator	Displays the capacity indicator. Displays the current weight as a blue bar with the capacity as 100 %.

5.10. Gross/Net/Tare Function

Gross/net/tare function usage

- The net/gross/tare functions allow you to output data for the gross weight, net weight and tare weight by optionally subtracting the tare.
- Change to the Gross weight/Tare weight display as follows:
 Display settings: [HOME] key  → [APP] button  → [Application] settings screen
 [Gross weight/Tare weight display] button → Select [ON].
 [HOME] key  → Weighing screen with the Gross weight/
 Tare weight display function
- When this function is enabled, the [TARE] button  for subtracting the tare is added.

Caution

- To output all of the net weight, gross weight and tare weight, configure the following data output settings.
 Display settings: [MENU] key  → [System settings] button  → [Communication] button  →
 [Data output] button
 [Data to be added] button  → [Gross weight/Tare weight display] button →
 Select [Gross weight + Tare weight].

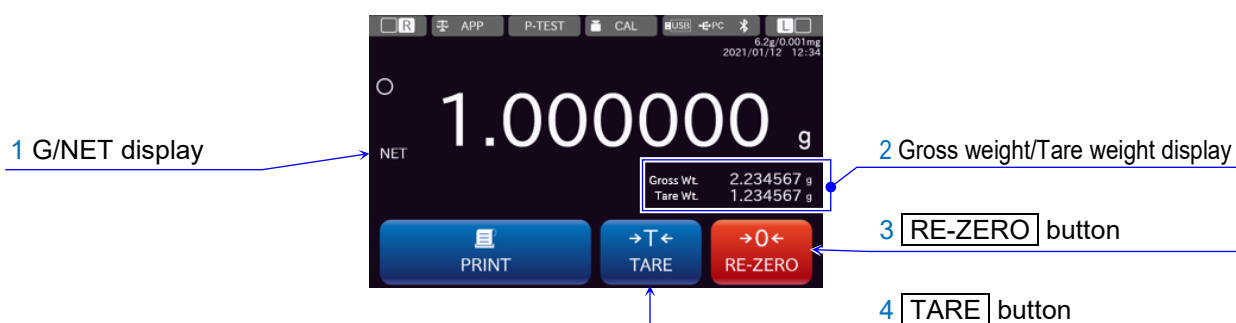

	Name	Description	
1	G/NET display	Displays the gross or net indicator. G (gross): Displayed when the tare weight is zero. NET (net): Displayed when the tare weight is non-zero.	
2	Gross weight/Tare weight display	Displays the current gross weight and tare weight.	
3	[RE-ZERO] button *1	Gross value: Within the zero range *2	Updates the zero point and clears the tare weight.
		Gross value: Exceeding the zero range *2	Performs the same operation as with the TARE button.
4	[TARE] button	Gross value: Positive value	Performs tare operation and updates the tare weight.
		Gross value: Gross zero *3	Clears the tare weight.
		Gross value: Negative value	Does not subtract the tare.

*1 Regardless of the weighing value, zero is displayed.

*2 For details about the zero range, refer to "5.2.2. Zero-point, tare, and weighing range".

*3 "Gross zero" means that the gross weight minimum division is in the range of zero when the unit is "g".

5.11. Warning display

□ Two types of warnings can be displayed according to the situation.

□ Enable the warning display as follows:

Display settings: **HOME** key  → **APP** button  → [Application] settings screen

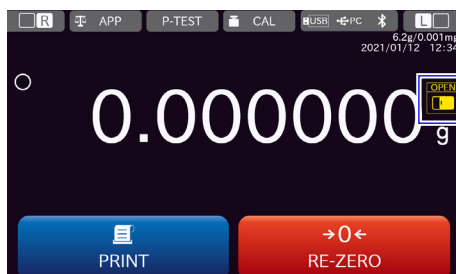

Warning display button → Select [ON]. (Factory setting)

HOME key  → Weighing screen with the warning display function



1 Warning display

	Name	Description
1	Warning display	Displays two types of warnings according to the situation of the balance.

Warning display	Name	Description	Display priority
	Shock indicator	Displayed with the impact level under load by the impact shock detection function.	High
	Static elimination recommended	Displayed when the relative humidity inside the balance is 45% or less. (Lights up for about 30 seconds after the start of weighing)	Medium
	Door open/close	Displayed when the left/right breeze break door is open.	Low





5.11.1. Impact shock detection (ISD) function

- This function detects impact shocks to the mass sensor section, displays the impact level, and records it. (Available with display unit software versions 1.010 or later)
- By lowering the impact level at the time of loading, it is possible not only to alleviate variation in the weighing value but also to reduce the risk of failure of the mass sensor section. Especially when incorporating the balance in a production line, etc. and weighing by means such as an automated system, impact greater than expected may be applied to the sensor. When designing automatic systems and the like, it is recommended that you minimize the impact level as much as possible while checking the shock indicator.
- Impacts of impact level 3 or higher are stored on the balance with date and time. For details, refer to “[13.29 Impact shock detection history](#)”. Impact shock detection history”.
- You can hide the impact level by turning off the Warning display button. If the impact level is level 3 or higher, the record will be kept automatically even if the impact level is hidden.



Caution

- Impact on the weighing sensor is not only that applied to the weighing pan when loaded, but also may be impact applied from the table on which the balance is installed. The impact detection function also works for impact coming from the table.

The shock indicator has 5 levels from level 0 to level 4.

Impact level	Shock indicator	Buzzer	Contents
Level 0	No indicator	No beeps	Safe
Level 1			Caution
Level 2			Caution: Alleviate impact shocks
Level 3		One beep	Warning: Do not apply any more impact shocks
Level 4		Two beeps	Danger: Sensor may be damaged

6. Quick Performance Check [Repeatability Measurement] Screen



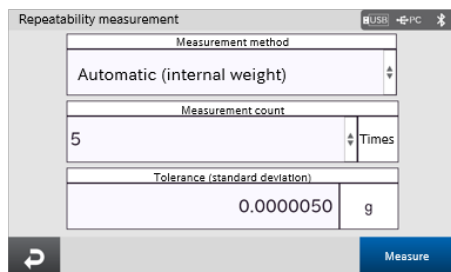



- You can access the quick performance check from the weighing screen with a single touch.
- Display the quick performance check as follows:
Display settings: **HOME** key  → **P-TEST** button  →
[Repeatability measurement] screen





Quick performance check usage

- The quick performance check screen is common to the repeatability check screen described in “[11.3. Repeatability check](#)”.
For details about setting each item, refer to “[11.3. Repeatability check](#)”.

7. Communication device

- Configure the simplified settings for the communication device connected to the balance.
The location of the [Communication device] button    corresponding to the connected device is lit in blue.
- You can configure settings such as the data format as follows:
Display settings: [MENU] key  → [System settings] button  → [Communication] button  → [Communication] screen

7.1.1. [Communication device] – [USB flash drive] settings

- Display the [USB flash drive] tab in the [Communication device] screen as follows:
Display settings: Weighing screen → [Communication device] button    →

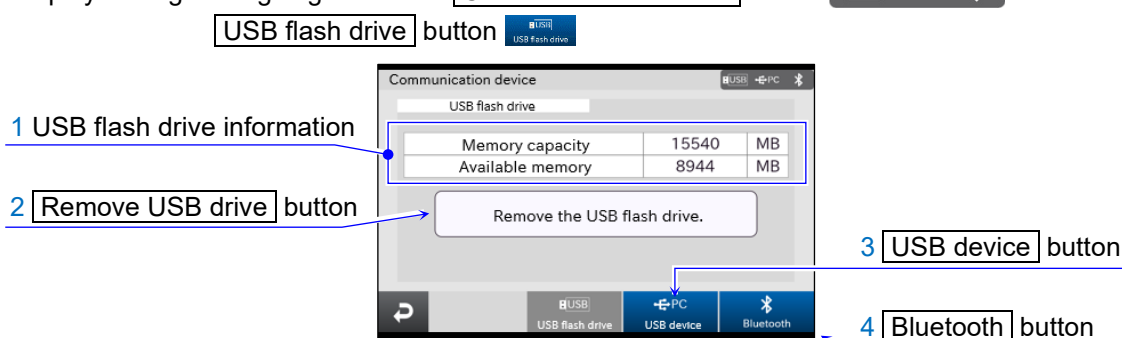

	Name	Description
1	USB flash drive information	Displays the information about the connected USB flash drive.
2	[Remove USB drive] button	Removes the USB flash drive.
3	[USB device] button	Displays the [Communication device] - [USB device] settings screen.
4	[Bluetooth] button	Displays the [Communication device] - [Bluetooth] settings screen.

Caution



- For details about handling the USB flash drive, refer to “[15.3. USB flash drive \(USB host\)](#)”.

USB flash drive usage

- For the BA-T series, you can connect the USB flash drive through the USB host interface.
You can save weighing data, etc. in the USB flash drive and import the data into Windows or macOS computers easily (no driver is required).

7.1.2. [Communication device] - [USB device] settings

- Display the [USB device tab in the [Communication device] screen as follows:

Display settings: Weighing screen → **Communication device** button  → **USB device** button 

1 USB function mode

2 **USB flash drive** button

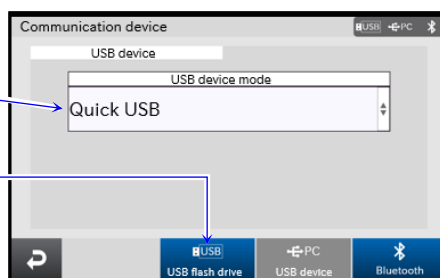

	Name	Setting value (setting range)	Description
1	USB function mode	Quick USB , Virtual COM	Selects the communication method between the balance and computer.
2	USB flash drive button	—	Displays the [USB flash drive] settings screen.

□ Settings in the red box are default values (factory settings).

Note

- You can use the USB miniB connector equipped as standard to connect the balance to PC. For details about the communication method, refer to “[13.14. USB interface](#)”.

7.1.3. [Communication device] - [Bluetooth] settings

- Display the [USB device] tab in the [Communication device] screen as follows:

Display settings: Weighing screen → **Communication device** button  → **Bluetooth** button 

1 Bluetooth mode

2 Connection status

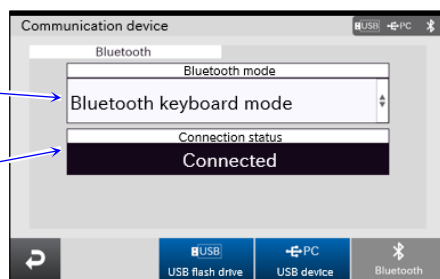

	Name	Setting value (setting range)	Description
1	Bluetooth mode	Bluetooth keyboard mode , Bluetooth serial mode	Switches the Bluetooth mode.
2	Connection status	-	Displays the Bluetooth connection status.

□ Settings in the red box are default values (factory settings).

Note





- Bluetooth allows the balance to be connected to computers and other devices. For details about the communication method, refer to “[13.16. Bluetooth](#)”.

8. Password Function

Intended use

- The password function allows you to restrict the use and functions of the balance.
It is effective in preventing falsification of date and time settings or preventing changes in the function table by the user.

Operation

- To log in, press the **LOG-IN** key  when the display is on, input the user name and password in the [Log-in] screen, and press the **Log-in** button .
- To log out, press the **Log-out** button  or **ON:OFF** key  to turn the display off.

How to manage balance functions/usage and factory settings

- User level
You can restrict functions at each user level.
At the factory setting, all functions are allowed at each user level.
There are four user levels: Administrator, Lab manager, Supervisor and Operator.
Users can select the Lab manager and Supervisor user levels.
Users who are not logged in are an Operator. (Users who do not use the password function)
- Administrator
Only the Administrator can restrict functions. Refer to “[8.2. User authorization](#)”.
The Administrator is registered before shipment and you cannot delete this user or change the user level of this user.
The password of the Administrator is “0000” at the factory setting. Be sure to change the password of the Administrator if you want to use the password function. If the password of the Administrator is lost or forgotten, you cannot manage users or change user authorization. Contact your local A&D dealer to reset the password.

8.1. Log-in screen

- Display the [Log-in] screen as follows:

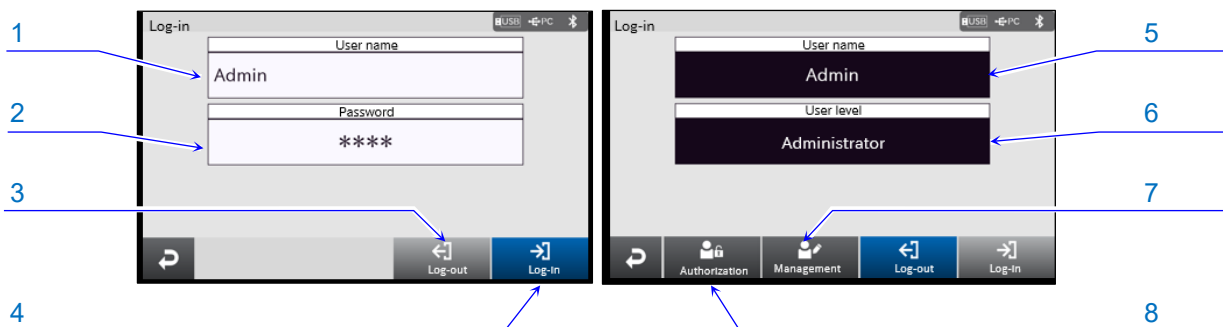

Display settings: Weighing screen → **LOG-IN** key  → [Log-in] screen



	Name	Description
1	User name input field	Input the user name for login. The length of user names is up to 20 characters.
2	Password input field	Input the set password. The password consists of alphanumerics with a length of 4 characters.
3	Log-out button	Logs out. * You can also press the ON:OFF key  to turn the display off and log out.
4	Log-in button	Logs in.
5	Log-in user name	Displays the logged in user name.
6	Log-in user level	Displays the user level of the logged in user.
7	User management button	Displays the [User management] screen. * Displayed only when the user is logged in as the Administrator.
8	User authorization button	Displays the [User authorization] settings screen. * Displayed only when the user is logged in as the Administrator.

8.2. User authorization

- Display the [Log-in] screen as follows:

Display settings: Weighing screen → **LOG-IN** key  → **User authorization** button  → [User authorization] settings screen

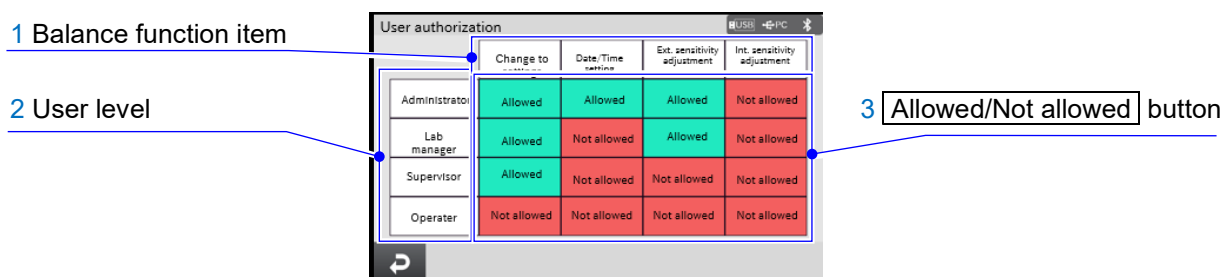

	Name	Description
1	Balance function item	Balance functions to restrict.
2	User level	User levels at which functions are restricted.
3	Allow/Not allowed button	These buttons switch between [Allowed] and [Not allowed] for the corresponding function at the restricted user level. At the factory setting, all functions are allowed at each user level.

8.2.1. User authorization - Change to settings not allowed

If changes to settings are not allowed in user authorization, the following buttons are disabled.

MENU screen - System settings

Display settings: **MENU** key  → [Menu] screen

Disabled button

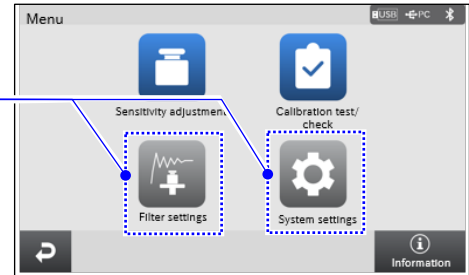



Sensitivity adjustment - Settings

Display settings: **MENU** key  → **Sensitivity adjustment** button  → [Sensitivity adjustment] screen

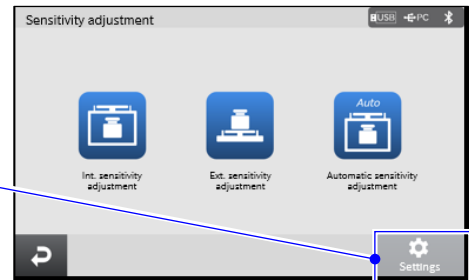
Disabled button



Calibration test/check screen - Settings

Display settings: **MENU** key  → **Calibration test/check** button  → [Calibration test/check] screen

- * There is a button for navigating to the same settings screen during a periodic check. This button is also disabled.

Disabled button

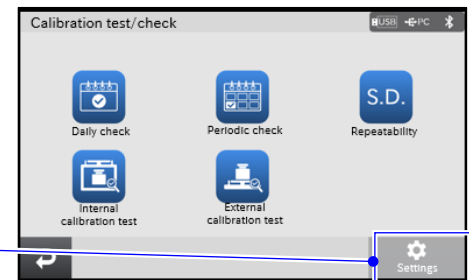

Counting mode screen - Counting mode setting

Display settings: **HOME** key  → **APP** button  → [Application] settings screen



Application selection button  → Select [Counting mode].

HOME key  → [Counting mode] screen

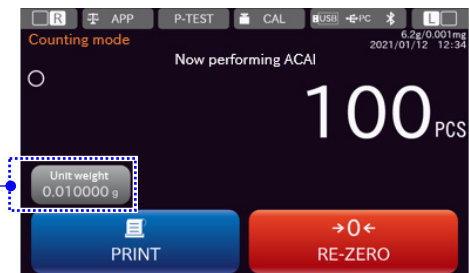
Disabled button



Percent weighing screen - Percent mode setting

Display settings: **HOME** key  → **APP** button  → [Application] settings screen



Application selection button  → Select [Percent mode].

HOME key  → [Percent weighing] screen

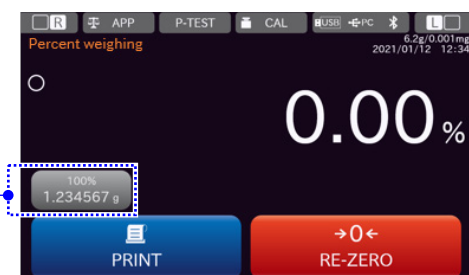
Disabled button



Weighing screen with the minimum weight alert function - Minimum weight setting



Display settings: **HOME** key  → **APP** button  → [Application] settings screen
Application selection button → Select [Minimum weight alert function].

HOME key  → Weighing screen with the minimum weight alert function

Disabled button



Statistical calculation results screen - Setting



Display settings: **HOME** key  → **APP** button  → [Application] settings screen
Statistical calculation function button → Select [ON].

HOME key  → Weighing screen with the statistical calculation function → **Statistical calculation results** button

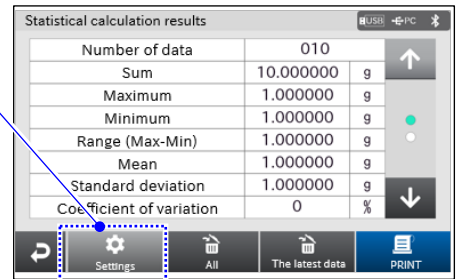
Disabled button



Formulation mode - Recipe list



Display settings: **HOME** key  → **APP** button  → [Application] settings screen
Application selection button → Select [Formulation mode]

HOME key  → [Formulation mode] screen → **Go to the recipe list** button → [Recipe list] screen

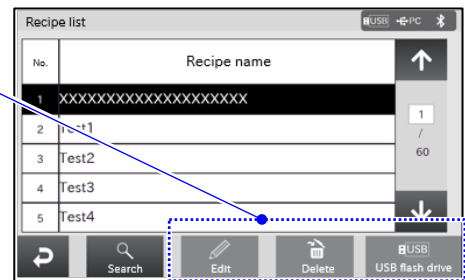
Disabled button



Formulation mode - Recipe search

Display settings: **HOME** key  → **APP** button  → [Application] settings screen
Application selection button → Select [Formulation mode]



HOME key  → [Formulation mode] screen → **Go to the recipe list** button →

Search button → [Recipe search] screen

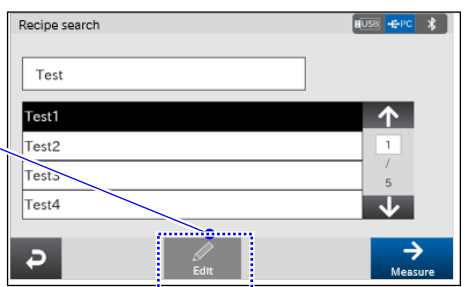
Disabled button



HPLC mode - Recipe list



Display settings: [HOME] key  → [APP] button  → [Application] settings screen
[Application selection] button → Select [HPLC mode]

[HOME] key  → [HPLC mode] screen → [Go to the recipe list] button → [Recipe list] screen

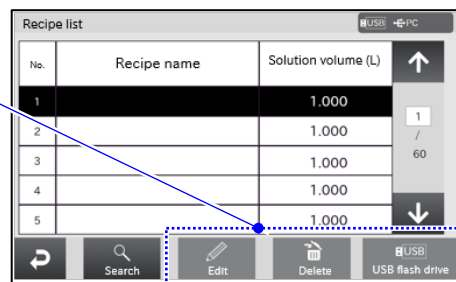
Disabled button



HPLC - Recipe search

Display settings: [HOME] key  → [APP] button  → [Application] settings screen
[Application selection] button → Select [HPLC mode]

[HOME] key  → [HPLC mode] screen → [Go to the recipe list] button →
[Search] button → [Recipe search] screen

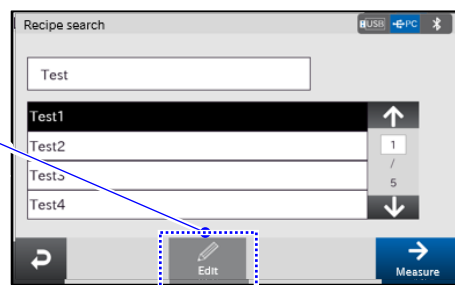

Disabled button



8.2.2. User authorization - Date/time setting not allowed

If the date/time setting is not allowed in user authorization, the following button is disabled.

System settings - Date/time setting

Display settings: [MENU] key  → [System settings] button  → [System settings] screen

Disabled button

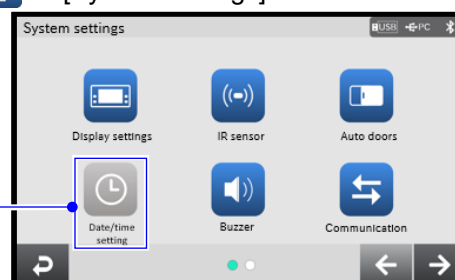

8.2.3. User authorization - Ext. sensitivity adjustment not allowed

If external calibration adjustment is not allowed in user authorization, the following buttons are disabled.

Sensitivity adjustment - Ext. sensitivity adjustment

Display settings: **MENU** key  → **Sensitivity adjustment** button  → [Sensitivity adjustment] screen

Disabled button

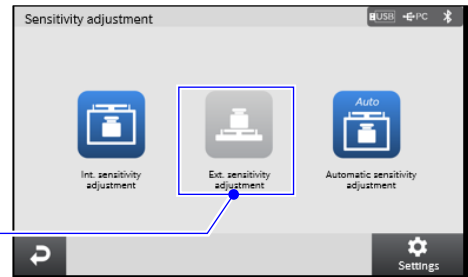



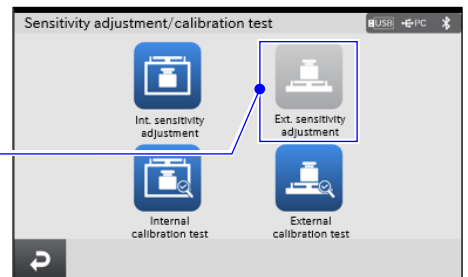

Sensitivity adjustment/calibration Test - Ext. sensitivity adjustment

Display settings: **HOME** key  → **CAL** button  → [Sensitivity adjustment/calibration test] screen

Disabled button



Periodic check - Sensitivity adjustment, Daily check - Sensitivity adjustment

Display settings: **MENU** key  → **Sensitivity adjustment** button  → **Calibration test/check** button  → **Daily check** button  → [Sensitivity adjustment] screen or **Periodic check** button  → [Sensitivity adjustment] screen

* If an external weight is used, the [Execute] button is disabled.

Disabled button

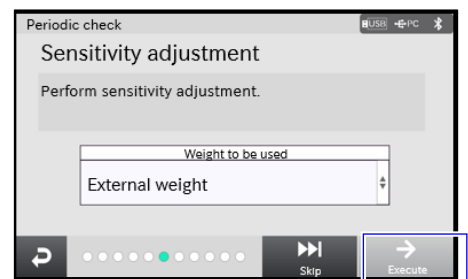

8.2.4. User authorization - Int. sensitivity adjustment not allowed

If internal sensitivity adjustment is not allowed in user authorization, the following buttons are disabled. In addition, when a user at a user level where the internal sensitivity adjustment is not allowed is logged in, the [Automatic sensitivity adjustment] button is also not allowed and no automatic sensitivity adjustment is performed.

Sensitivity adjustment - Int. sensitivity adjustment

Display settings: [MENU] key  → [Sensitivity adjustment] button  → [Sensitivity adjustment] screen

Disabled button

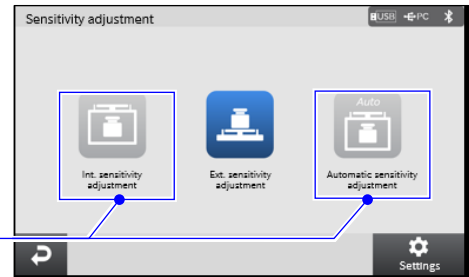



Sensitivity adjustment/calibration Test - Int. sensitivity adjustment

Display settings: [HOME] key  → [CAL] button  → [Sensitivity adjustment/calibration test] screen

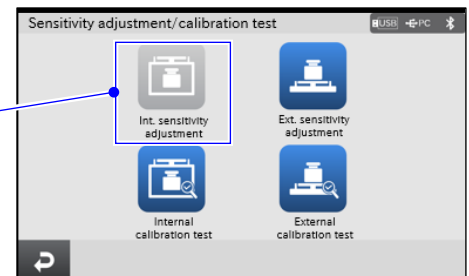
Disabled button



Periodic check - Sensitivity adjustment, Daily check - Sensitivity adjustment

Display settings: [MENU] key  → [Sensitivity adjustment] button  → [Calibration test/check] button 
[Daily check] button → [Sensitivity adjustment] screen or
[Periodic check] button → [Sensitivity adjustment] screen

- * If an external weight is used, the [Execute] button is disabled.

Disabled button

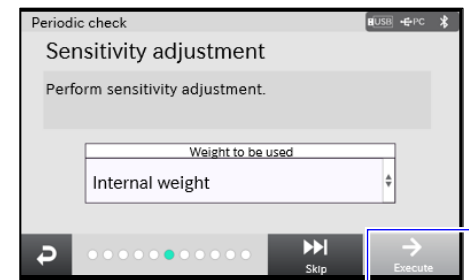

8.3. User management

- Display the [User management] screen as follows:

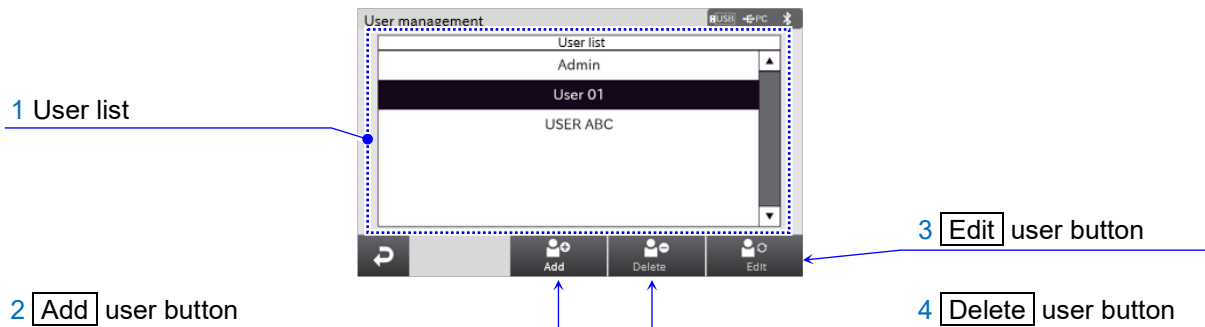

Display settings: Weighing screen → LOG-IN key  → User management button  → [User management] screen



	Name	Description
1	User list	Displays the registered users. Only Admin is registered at the factory setting. Up to 100 users can be registered. When you want to register or delete a user, select the target user.
2	Add user button	Displays the [User management] screen for registration described in “8.3.1. User management for registration ”.
3	Edit user button	Displays the [User management] screen for edit described in “8.3.2. User management for edit ”.
4	Delete user button	Delete the selected user. A confirmation dialog is displayed before deletion. You cannot delete Admin.

8.3.1. User management for registration

- Display the [User management] screen for registration as follows:

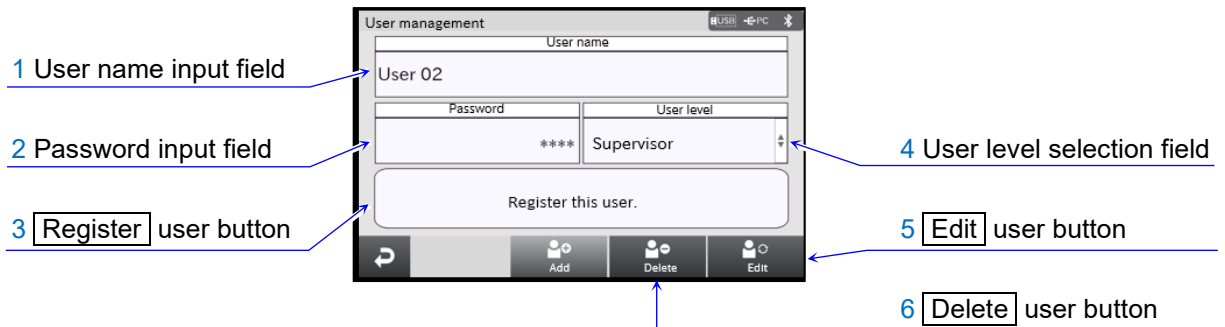

Display settings: Weighing screen → **LOG-IN** key  → **User management** button  → **Add** user button → [User management] screen for registration



	Name	Description
1	User name input field	Set the user to register. The length of user names is up to 20 characters.
2	Password input field	Set the password to register. The password consists of alphanumerics with a length of 4 characters.
3	Register user button	Registers the set user.
4	User level selection field	Set the user level to register. Select either [Supervisor] or [Lab manager].
5	Edit user button	Displays the [User management] screen for edit described in “8.3.2. User management for edit”.
6	Delete user button	Displays the [User management] screen described in “8.3. User management”. Displays the user list.

8.3.2. User management for edit

- Display the [User management] screen for edit as follows:

Display settings: Weighing screen → **LOG-IN** key  → **User management** button  → **Edit** user button → [User management] screen for edit

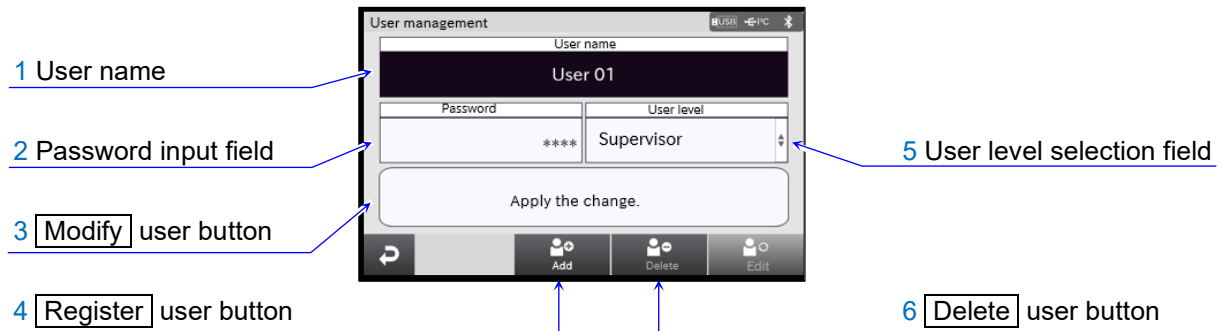

	Name	Description
1	User name	Displays the user to be modified.
2	Password input field	Set the password to register. The password consists of alphanumeric characters with a length of 4 characters.
3	Modify user button	Applies the set password and user level.
4	Register user button	Displays the [User management] screen for registration described in “8.3.1. User management for registration”.
5	User level selection field	Set the user level to register. Select either [Supervisor] or [Lab manager].
6	Delete user button	Displays the [User management] screen described in “8.3. User management”. Displays the user list.

9. Menu Screen

- Display the [Menu] screen as follows:



Display settings: **MENU** key  → [Menu] screen



	Name	Description
1	Sensitivity adjustment button	Displays the [Sensitivity adjustment] screen. You can configure the operation and settings for the internal sensitivity adjustment and external sensitivity adjustment.
2	Filter settings button	Displays the [Filter settings] screen. You can configure the response characteristics, stability bandwidth and zero tracking settings.
3	Back button	Displays the weighing screen.
4	Calibration test/check button	Displays the [Calibration test/check] screen. You can configure the operation and settings for the daily check, periodic check, repeatability check, etc.
5	System settings button	Displays the [System settings] screen. You can configure settings for the display, buttons, IR sensors, communication language, clock, etc.
6	Information button	Displays the [Information] screen. You can check the balance information, software version and history.

10. [Sensitivity adjustment] screen

- Display the [Sensitivity adjustment] screen as follows:

Display settings: [MENU] key  → [Sensitivity adjustment] button  → [Sensitivity adjustment] screen

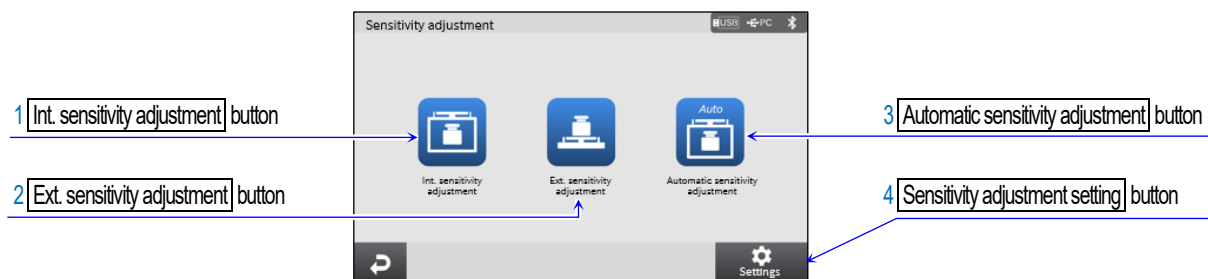



	Name	Description
1	[Int. sensitivity adjustment] button	Displays the [Internal sensitivity adjustment] screen to execute the internal sensitivity adjustment. After adjustment, the [Sensitivity adjustment result] screen for the internal sensitivity adjustment is displayed.
2	[Ext. sensitivity adjustment] button	Displays the [External sensitivity adjustment] screen to start the external sensitivity adjustment. After adjustment, the [Sensitivity adjustment result] screen for the external sensitivity adjustment is displayed.
3	[Automatic sensitivity adjustment] button	Displays the [Automatic sensitivity adjustment] settings screen. The automatic sensitivity adjustment is executed.
4	[Sensitivity adjustment setting] button	Displays the [Sensitivity adjustment setting] screen. You can configure the settings for the [CAL] button, standard value for external weight values and internal weight value correction for the weighing screen.

- Since the balance's resolution is high, weighing values may change due to gravity and daily environmental changes. It is necessary to perform sensitivity adjustment with the weight in order to keep the weighing values from changing even if gravity or the environment changes.
It is recommended that you perform sensitivity adjustment if the balance is installed for the first time or relocated, or when the weighing values change significantly in daily check, etc.
- Sensitivity adjustment means to adjust the weighing value of the balance using the reference weight or internal weight.

Caution on sensitivity adjustment

- Do not allow vibration, drafts or temperature changes to affect the balance especially during sensitivity adjustment.
- The GLP/GMP (etc.) compliant report can be output in sensitivity adjustment. A computer or optional printer is required for GLP output. A timestamp (clock and calendar) is available for the GLP output using the clock function of the balance.
- You can set the clock function from the [Date/time setting] screen.

Display settings: [MENU] key  → [System settings] button  → [Date/time] button  → [Date/time setting] screen

10.1. Internal sensitivity adjustment

Display settings 1: **MENU** key  → **Sensitivity adjustment** button  →

Int. sensitivity adjustment button  → [Internal sensitivity adjustment] screen

Display settings 2: **HOME** key  → **CAL** button  → **Int. sensitivity adjustment** button  →

[Internal sensitivity adjustment] screen



	Name	Description
1	Back button	Returns to the previous screen.
2	Date	Displays the date when the internal sensitivity adjustment was complete.
3	Time	Displays the time when the internal sensitivity adjustment was complete.
4	Weight used	Displays the weight used.
5	PRINT button	Outputs the sensitivity adjustment result. The result is automatically output if [GLP output] in [Data output] is set to ON.



The balance performs sensitivity adjustment using the internal weight.



- Be sure to warm up the balance with nothing on the weighing pan for at least an hour, or at least four hours for BA-6TE/6DTE, with the AC adapter connected to the power supply.
- Do not apply vibration and the like to the balance during sensitivity adjustment.
- When the adjustment is complete, the [Sensitivity adjustment result] screen for the internal sensitivity adjustment is automatically displayed.

About the internal weight

- The value of the internal weight may change due to factors such as the operating environment and aging.
- Correct the internal weight value as necessary by referring to “Correcting the internal weight value”.
- In order to maintain the weighing accuracy, it is advisable to perform the external sensitivity adjustment regularly.

10.2. External sensitivity adjustment

Display settings 1: **MENU** key  → **Sensitivity adjustment** button  →
Ext. sensitivity adjustment button  → [External sensitivity adjustment] screen

Display settings 2: **HOME** key  → **CAL** button  CAL →
Ext. sensitivity adjustment button  → [External sensitivity adjustment] screen

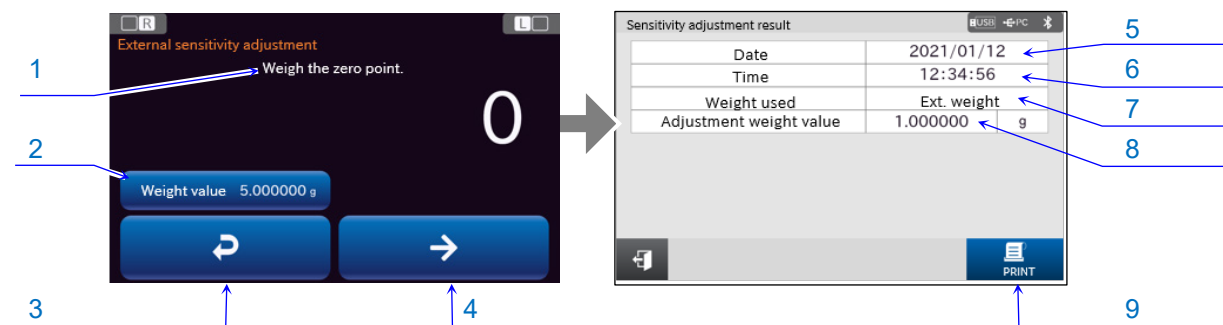

	Name	Description
1	Instruction display	Displays the instruction for external sensitivity adjustment.
2	External weight value input field	Input the external weight value. This is common to the external weight value input field in the [Sensitivity adjustment result] screen for external sensitivity adjustment. Input range BA-6TE/BA-6DTE : 0.9 g ~ 5 g ~ 5.1 g BA-225TE/BA-225DTE : 9.9 g ~ 200 g ~ 200.1 g BA-125DTE : 9.9 g ~ 100 g ~ 100.1 g
3	Back button	Returns to the previous screen.
4	Confirm button	Confirms the current input setting and proceeds to the next instruction.
5	Date	Displays the date when the external sensitivity adjustment was complete.
6	Time	Displays the time when the external sensitivity adjustment was complete.
7	Weight used	Displays the type of the weight used.
8	Adjustment weight value	Displays the weight value used.
9	PRINT button	Outputs the sensitivity adjustment result. The result is automatically output if [GLP output] in [Data output] is set to ON.

Settings in the red box are default values (factory settings).

This function performs sensitivity adjustment of the balance using your external weight.

- ❑ Be sure to warm up the balance with nothing on the weighing pan for at least an hour, or at least four hours for BA-6TE/6DTE, with the AC adapter connected to the power supply.
- ❑ Do not apply vibration and the like to the balance during sensitivity adjustment.
- ❑ When the adjustment is complete, the [Sensitivity adjustment result] screen for the external sensitivity adjustment is automatically displayed.

Caution

- ❑ The accuracy of the weight used in sensitivity adjustment affects the accuracy of the balance after sensitivity adjustment.

10.2.1. Procedure for external sensitivity adjustment

Weighing example for BA-6DTE

- Step 1. Make sure that nothing is on the weighing pan and press the **Confirm** button .
- The balance measures the zero point.
- Do not apply vibration and the like to the balance.
- * You can input the external weight value before input.

- Step 2. Place the weight on the weighing pan and press the **Confirm** button .
- Measure the weight.
- Do not apply vibration and the like to the balance.
- * You can input the external weight value before input.

- Step 3. The [Sensitivity adjustment result] screen for the external sensitivity adjustment is automatically displayed. Please remove the weight.

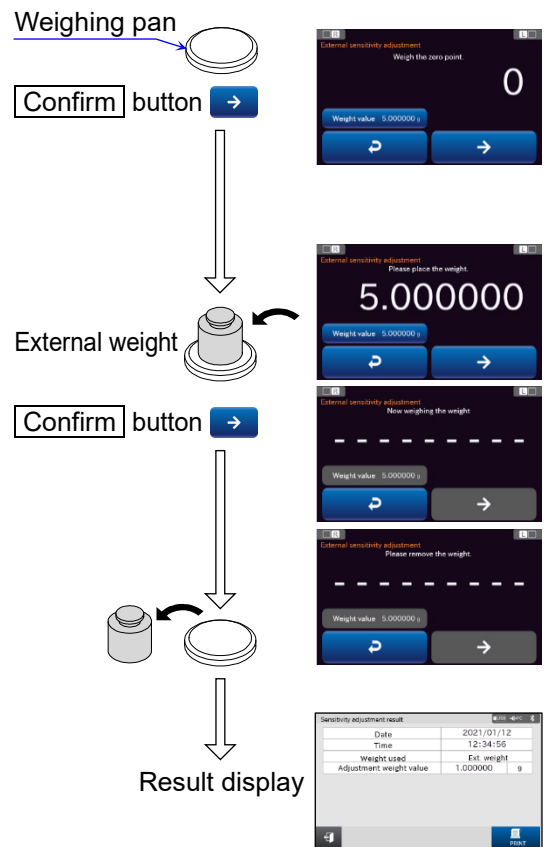

- Step 4. You can output the result by pressing the **PRINT** button .
- * The result is automatically output if [GLP output] in [Data output] is set to ON.

- Step 5. Press the **HOME** key  to return to the weighing screen.
- Place the weight again to confirm that the sensitivity of the balance is adjusted properly.
- If it is not within the range, start over from the first step of this procedure in the appropriate ambient conditions.



GLP output  **PRINT** button 

10.3. Automatic sensitivity adjustment

Display settings: **MENU** key  → **Sensitivity adjustment** button  → **Automatic sensitivity adjustment** button  → [Automatic sensitivity adjustment] settings screen

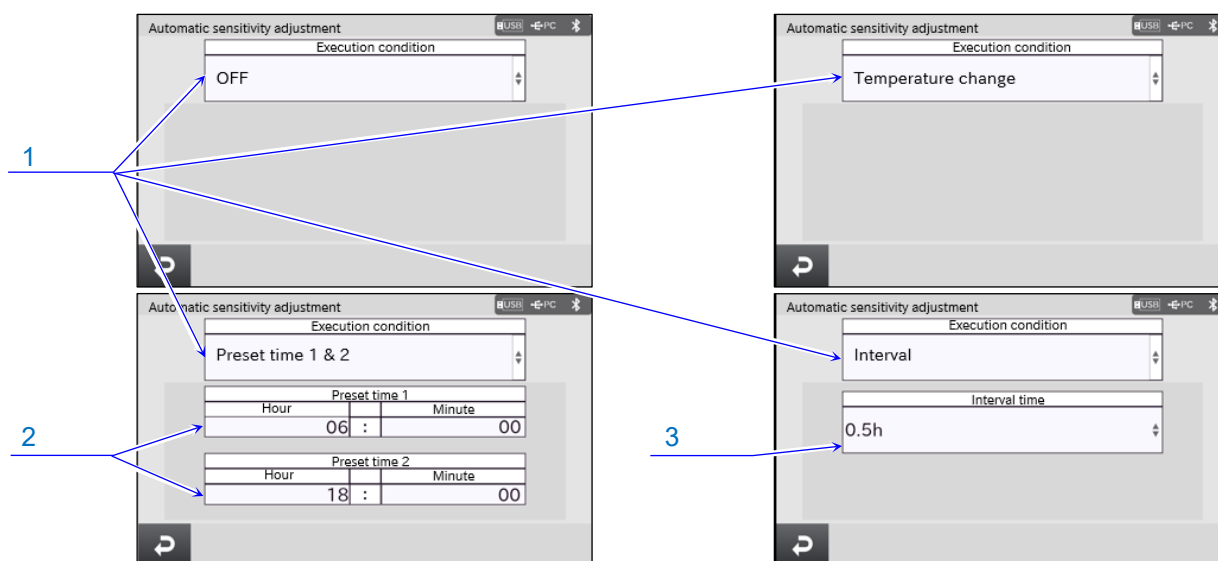

	Name	Setting value (setting range)	Description
1	Automatic sensitivity adjustment execution condition setting field	OFF, Temperature change , Preset time 1, Preset time 1&2, Interval	Set the automatic sensitivity adjustment execution condition. If you select the preset time or interval, the relevant time setting is displayed below the setting field.
2	Automatic sensitivity adjustment time setting	0:00 - 24:00	Set the automatic sensitivity adjustment start time.
3	Automatic sensitivity adjustment interval setting	0.5 , 1.0, 1.5, 2.0, 2.5, 3.0, 3.5, 4.0, 4.5, 5.0, 5.5, 6.0, 7.0, 8.0, 9.0, 10.0, 11.0, 12.0, 14.0, 16.0, 18.0, 20.0, 22.0, 24.0	Set the automatic sensitivity adjustment interval.

Settings in the red box are default values (factory settings).

This function automatically adjusts the sensitivity of the balance according to ambient temperature change, set time or interval time using the internal weight. It works even when the display is off. If the GLP output is enabled, the sensitivity adjustment execution record is output after the sensitivity adjustment.

- The execution condition for the automatic sensitivity adjustment can be based on the temperature change, preset time or interval.
- For preset time, you can configure two settings: "Preset time 1" and "Preset time 2".
- For the interval, you can set a value between 0.5h and 24.0h.

Caution



- If something is on the weighing pan, the balance itself will judge that it is in use and will not perform automatic sensitivity adjustment.

The criteria for performing automatic sensitivity adjustment are as follows.

BA-6TE / BA-6DTE	Less than 0.1 g
BA-225DTE / BA-125DTE / BA-225TE	

- To maintain the correct sensitivity adjustment of the balance, do not place anything on the weighing pan while not in use.

10.4. Sensitivity adjustment setting

Display settings: **MENU** key  → **Sensitivity adjustment** button  → **Settings** button  → [Sensitivity adjustment setting] screen

1 External weight value input

2 **Enter the correct internal weight value** button

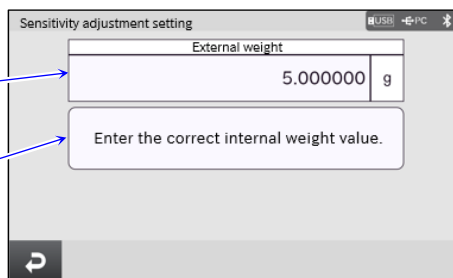

	Name	Setting value (setting range)	Description
1	External weight value input	Input range *1	Input the external weight value. This is common to the “Adjustment weight value” input item in the [External sensitivity adjustment] screen.
2	Enter the correct internal weight value button	—	Displays the [Internal sensitivity adjustment] screen.

 Settings in the red box are default values (factory settings).



*1 Input range

BA-6TE/BA-6DTE : 0.9 g ~ **5 g** ~ 5.1 g

BA-225TE/BA-225DTE : 9.9 g ~ **200 g** ~ 200.1 g

BA-125DTE : 9.9 g ~ **100 g** ~ 100.1 g

10.5. Correcting the internal weight value

Display settings: **MENU** key  → **Sensitivity adjustment** button  → **Settings** button  → **Enter the correct internal weight value** button → [Internal sensitivity adjustment] screen

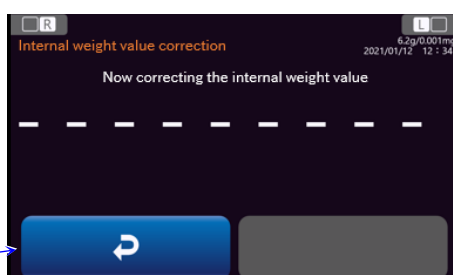

1 **Back** button



	Name	Description
1	Back button	Returns to the previous screen.

- This function corrects the internal weight value based on your external weight. Execute the external sensitivity adjustment in advance.
The balance automatically loads and unloads the internal weight and corrects the internal weight value. Then the balance automatically executes the internal sensitivity adjustment. When the adjustment is complete, the [Sensitivity adjustment setting] screen is displayed.
The corrected value is stored in nonvolatile memory even if the AC adapter is removed.

11. Calibration test/check

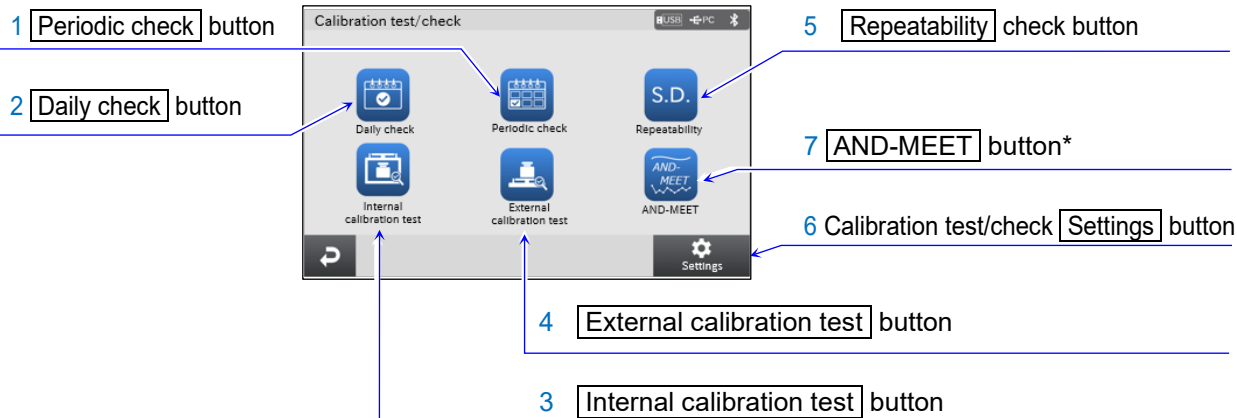

Display settings: [MENU] key  → [Calibration test/check] button  → [Calibration test/check] screen



	Name	Description
1	[Periodic check] button	Executes the periodic check.
2	[Daily check] button	Executes the daily check.
3	[Internal calibration test] button	Executes the internal calibration test.
4	[External calibration test] button	Executes the external calibration test.
5	[Repeatability] check button	Displays the [Repeatability measurement] screen for check.
6	Calibration test/check [Settings] button	Displays the [Calibration test/check] settings screen.
7	[AND-MEET] button	Displays the [AND-MEET] screen.

* Supported with the touch panel software version 1.019 or later

11.1. Daily check

Display settings: [MENU] key  → [Calibration test/check] button  → [Daily check] button
 [Daily check] screen, [Environmental conditions] screen (From this screen, display check items in sequence)

Daily check details

During daily check, you check the minimum required items for using the balance to make sure that there is no serious error with the balance. It is advisable to perform this check every day before work, though this may depend on the maintenance level of the balance.

1 Environmental conditions

Make sure that the operating temperature and humidity of the balance fall within the specifications. If the humidity is 45 %RH or less, it is recommended that static elimination be performed before weighing.

Be sure to warm up the balance before use for at least an hour, or at least four hours for BA-6TE/6DTE, with the AC adapter connected to the power supply.

The warm-up time is the period of time when the power to the balance is on before use.

* You can measure up to 9999 hours for the warm-up time.

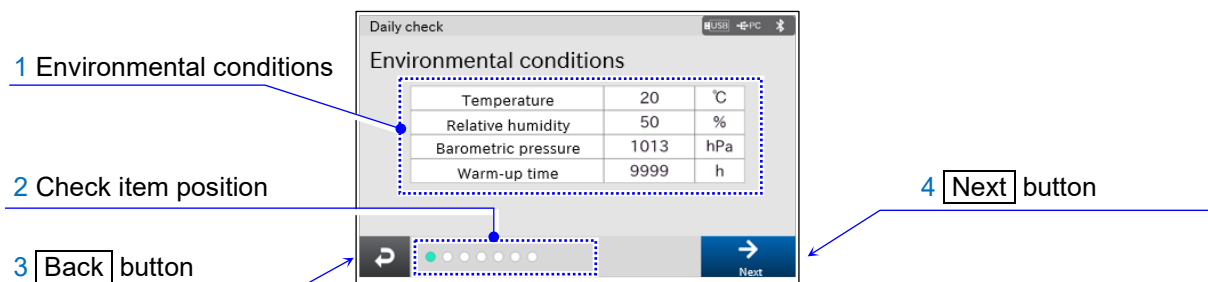

	Name	Description
1	Environmental conditions	Displays the environmental conditions.
2	Check item position	Displays the position of the current check item.
3	[Back] button	Returns to the [Calibration test/check] screen.
4	[Next] button	Considers this check item as OK and proceeds to the next item.

2. Balance handling level

- Check the balance handling level.

The balance handling level is calculated based on the following data.

- The number of times the balance has detected an impact since the last periodic check
- Impact level detected by the balance

	Balance handling level	Description
Good ↑↓ Bad	A	No potentially damaging impact on the balance has been detected. The balance has been used without any problems.
	B	Several potentially damaging impacts on the balance have been detected. Please take care when placing an object on the balance.
	C	Many potentially damaging impacts on the balance have been detected. It is advised to carry out periodic check of the balance.

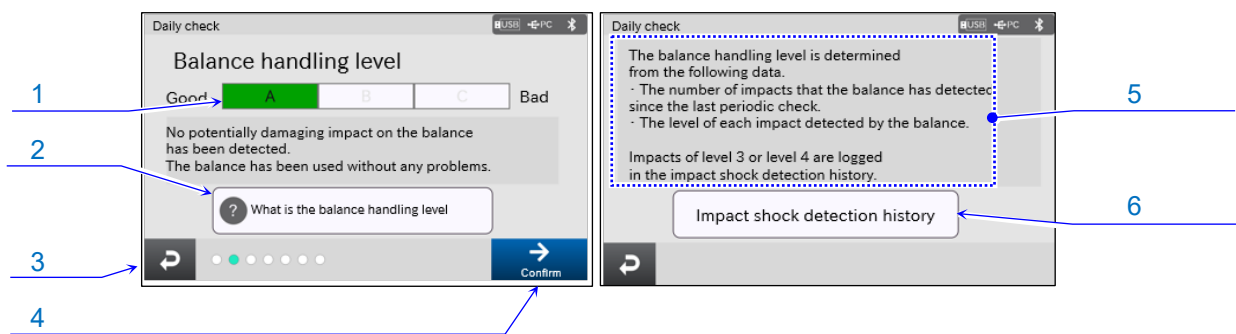

	Name	Description
1	Balance handling level	Displays the level of balance handling.
2	Explanation of Balance handling level button	Displays the screen for explaining balance handling level.
3	Back button	Returns to the previous screen.
4	Confirm button	Considers this check item as OK and proceeds to the next item.
5	Explanation of balance handling level	Balance handling level is explained.
6	Impact shock detection history button	Displays the [Impact shock detection history] screen.

3. External condition check

- Make sure that the area around the weighing pan in the breeze break is clean.
If it is dirty, clean it. Contamination may result.
- Make sure that the balance body is not damaged or deformed.
Damage or deformation may result in malfunction of the balance or injury to users.

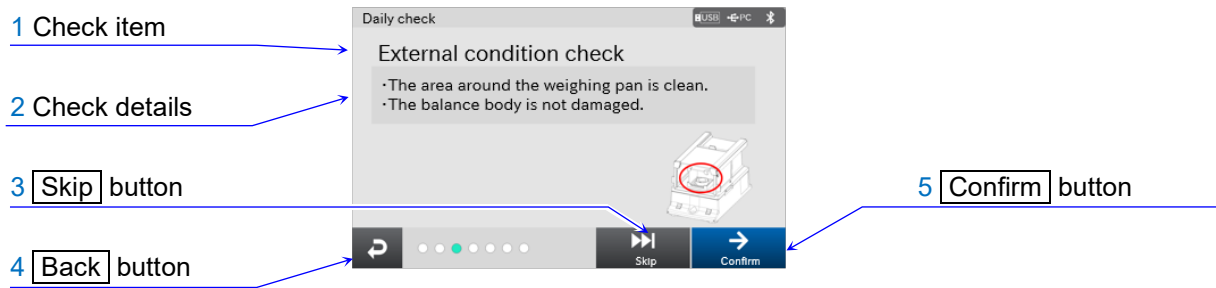

	Name	Description
1	Check item	Displays check items.
2	Check details	Displays check details.
3	Skip button	Skips this check item and proceeds to the next item.
4	Back button	Returns to the previous screen.
5	Confirm button	Considers this check item as OK and proceeds to the next item.

4. Level check

- Make sure that the air bubble on the spirit level is in the center of the circle. If it is not in the center, accurate weighing is not possible.
- Refer to the leveling method and rotate the leveling feet to adjust the level of the balance. The leveling method is the same as with the periodic check.

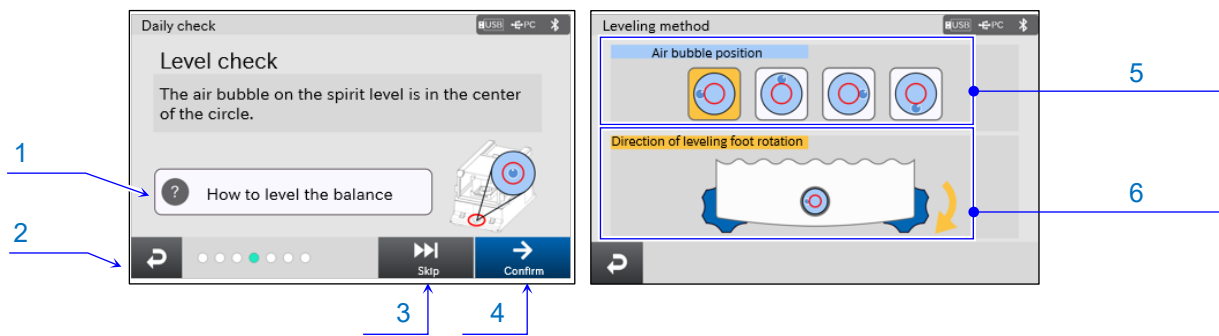

	Name	Description
1	Leveling method button	Displays the [Leveling method] screen.
2	Back button	Returns to the previous screen.
3	Skip button	Skips this check item and proceeds to the next item.
4	Confirm button	Considers this check item as OK and proceeds to the next item.
5	Air bubble position button	Touch the current air bubble position.
6	Direction of leveling foot rotation	Displays the direction of rotating the leveling foot in order to adjust the level of the balance. Images depend on the air bubble position.

5. Weighing pan check

- Make sure that there is nothing on the weighing pan.

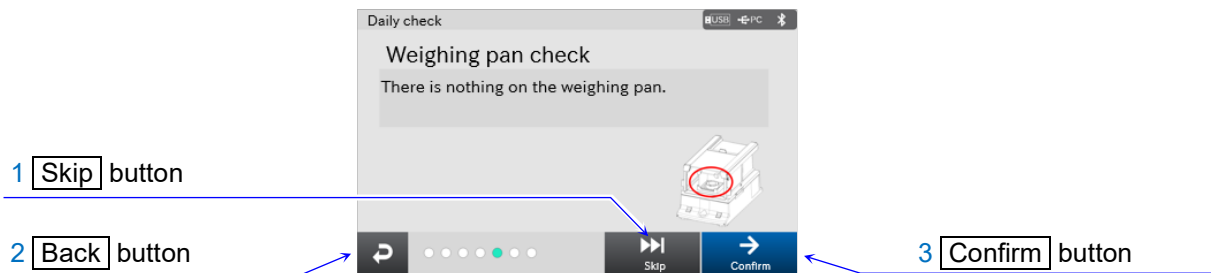

	Name	Description
1	[Skip] button	Skips this check item and proceeds to the next item.
2	[Back] button	Returns to the previous screen.
3	[Confirm] button	Considers this check item as OK and proceeds to the next item.

6 Accuracy check

- Use your test weight to make sure that the deviation falls within the tolerance.

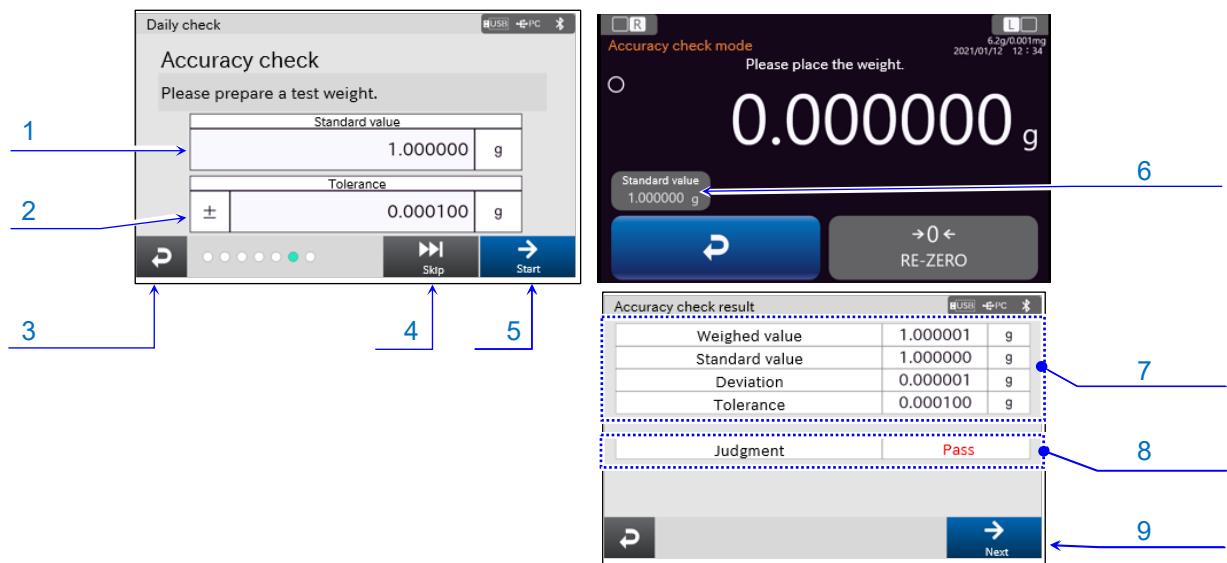

	Name	Description
1	Test weight value input field	Input the value for your test weight.
2	Tolerance input field	Input the tolerance.
3	[Back] button	Returns to the previous screen.
4	[Skip] button	Skips this check item and proceeds to the next item.
5	Accuracy check [Start] button	Displays the [Accuracy check mode] screen.
6	Test weight value input field	Input the value for your test weight. This is common to the one in the [Accuracy check] screen.
7	Accuracy check result display	Displays the accuracy check result.
8	Judgment	Displays the judgment.
9	[Next] button	Proceeds to the next check item.

7. Daily Check Results

- The results of all daily check items are displayed.

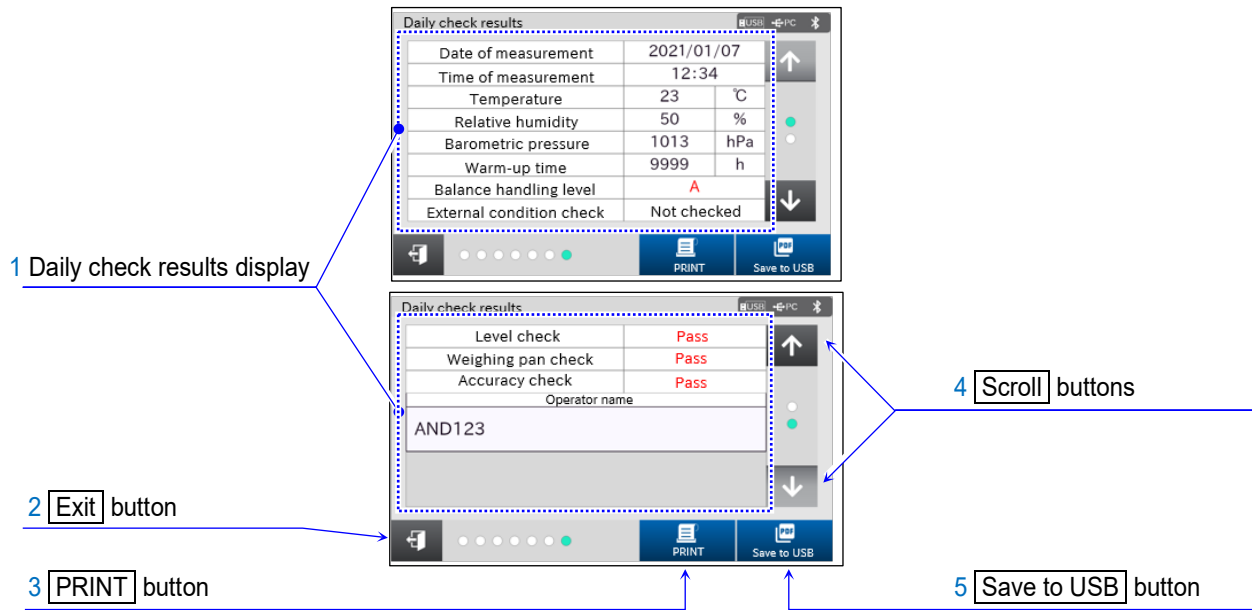

	Name	Description
1	Daily check results display	Shows the results of the daily check.
2	Exit button	Exits the daily check and displays the [Calibration test/check] screen.
3	PRINT button	Outputs the daily check results to the device connected to the balance.
4	Scroll buttons	Select the page.
5	Save to USB button	Outputs PDF data containing the daily check results to the USB flash drive connected to the balance.

11.1.1. Output example for daily check output results

Daily check output results

```

---DAILY CHECK---
                A & D
MODEL          BA-6TE
S/N           123456789
ID LAB-012345678
DATE          2021/01/23
TIME          12:34:56

TEMP          25 C
HR            50 %
BAR           1000hPa
WARM UP       1 h

HANDLING LEVEL
EXT.CONDITION
LEVEL CHECK
WEIGHING PAN

WEIGHT CHECK
SETTING
1.000000 g
MEASURED
0.999999 g
SPEC.
0.000100 g
JUDGEMENT     OK

REMARKS

SIGNATURE
    
```

Daily check PDF results



Daily Balance Check Report

Date : 01/01/2021 12:00:00
 Location :
 Weight used :

1. Balance

Model : BA-6TE Capacity : 6.2 g Readability : 0.001mg
 Serial No. : 123456789 ID No. : LAB-012345678

2. Environmental conditions

Temperature : 25 °C Relative humidity : 50 %
 Barometric Pressure : 1000 hPa Warm-up time : 1 h

3. Check items

3-1. Balance handling level

Good	B	Bad
------	---	-----

3-2. External condition check

- The area around the weighing pan is clean : Pass
- The balance body is not damaged : Pass

3-3. Level check

- The air bubble on the spirit level is in the center of the circle : Pass

3-4. Weighing pan check

- There is nothing on the weighing pan : Pass



3-5. Accuracy check : Pass

Std value	1.000000 g	Weighed value	1.000001 g
Deviation	0.000001 g	Judgment	0.000050 g

4. Remarks _____

Signature (Operator) _____
 Signature (Manager) _____

11.2. Periodic check

Display settings: **MENU** key  → **Calibration test/check** button  → **Periodic check** button  → [Periodic check] screen, [Environmental conditions] screen (From this screen, display check items in sequence)

Periodic check details

During the periodic check, a weight is used to check basic properties of the balance including the repeatability, linearity and eccentricity and manage how weighing values perform against the specifications. It is advisable to perform this check once per week or month, though this may depend on the maintenance level of the balance.

1 Environmental conditions

- Make sure that the operating temperature and humidity of the balance fall within the specifications. If the humidity is 45 %RH or less, it is recommended that static elimination be performed before weighing.
- Be sure to warm up the balance before use for at least an hour, or at least four hours for BA-6TE/6DTE, with the AC adapter connected to the power supply.

The warm-up time is the period of time when the power to the balance is on before use.

* You can measure up to 9999 hours for the warm-up time.

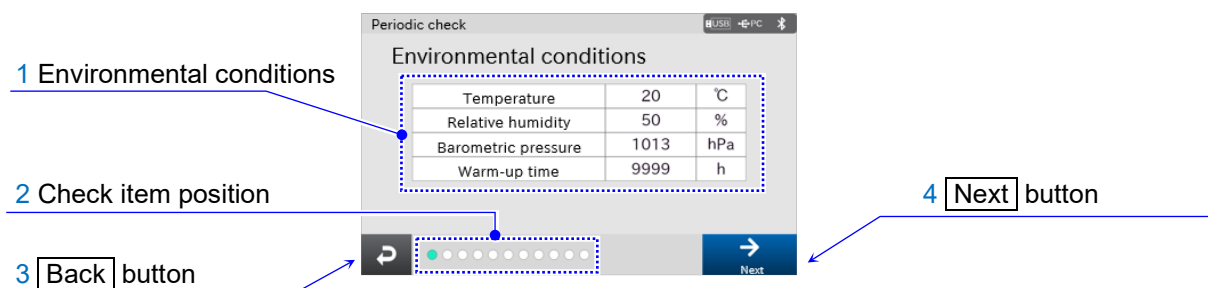

	Name	Description
1	Environmental conditions	Displays the environmental conditions.
2	Check item position	Displays the position of the current check item.
3	Back button	Returns to the [Calibration test/check] screen.
4	Next button	Considers this check item as OK and proceeds to the next item.

2. External condition check

- Make sure that the area around the weighing pan in the breeze break is clean.
If it is dirty, clean it. Contamination may result.
- Make sure that the balance body is not damaged or deformed.
Damage or deformation may result in malfunction of the balance or injury to users.

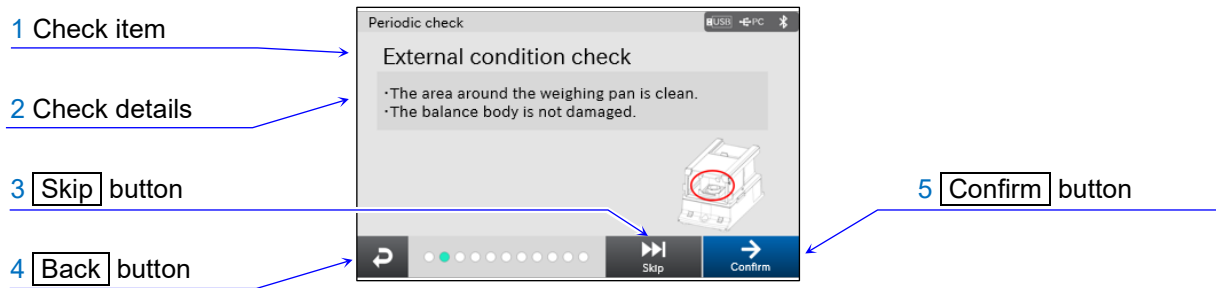

	Name	Description
1	Check item	Displays check items.
2	Check details	Displays check details.
3	Skip button	Skips this check item and proceeds to the next item.
4	Back button	Returns to the previous screen.
5	Confirm button	Considers this check item as OK and proceeds to the next item.

3. Level check

- Make sure that the air bubble on the spirit level is in the center of the circle. If it is not in the center, accurate weighing is not possible.
- Refer to the leveling method and rotate the leveling feet to adjust the level of the balance. The leveling method is the same as with the daily check.

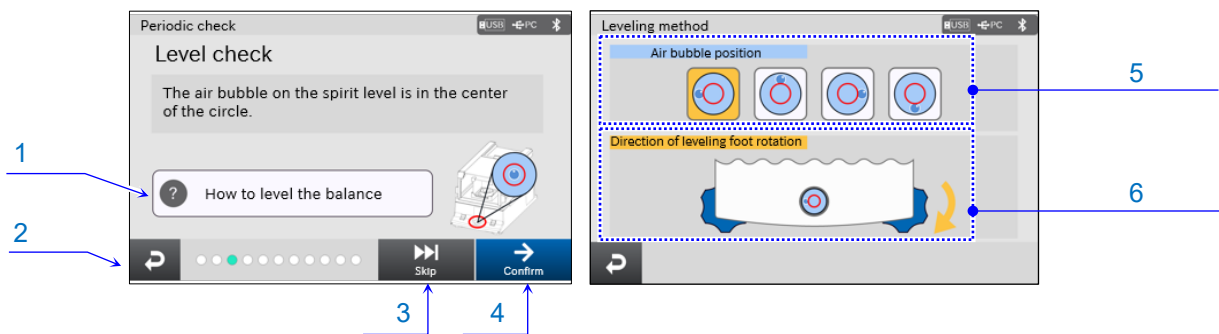

	Name	Description
1	Leveling method button	Displays the [Leveling method] screen.
2	Back button	Returns to the previous screen.
3	Skip button	Skips this check item and proceeds to the next item.
4	Confirm button	Considers this check item as OK and proceeds to the next item.
5	Air bubble position button	Touch the current air bubble position.
6	Direction of leveling foot rotation	Displays the direction of rotating the leveling foot in order to adjust the level of the balance. Images depend on the air bubble position.

4. Weighing pan check

- Make sure that there is nothing on the weighing pan.

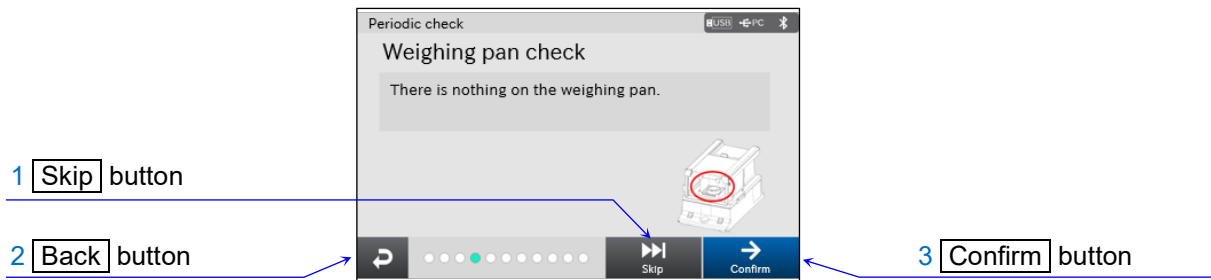

	Name	Description
1	Skip button	Skips this check item and proceeds to the next item.
2	Back button	Returns to the previous screen.
3	Confirm button	Considers this check item as OK and proceeds to the next item.

5. Calibration Test (Before Sensitivity Adjustment)

- The calibration test is performed before sensitivity adjustment.

When the test is completed, the [Calibration test result] screen is displayed.

- When the internal weight is used, this is automatically performed. When an external weight is used, follow the instruction.

Do not apply vibration and the like to the balance during the calibration test.

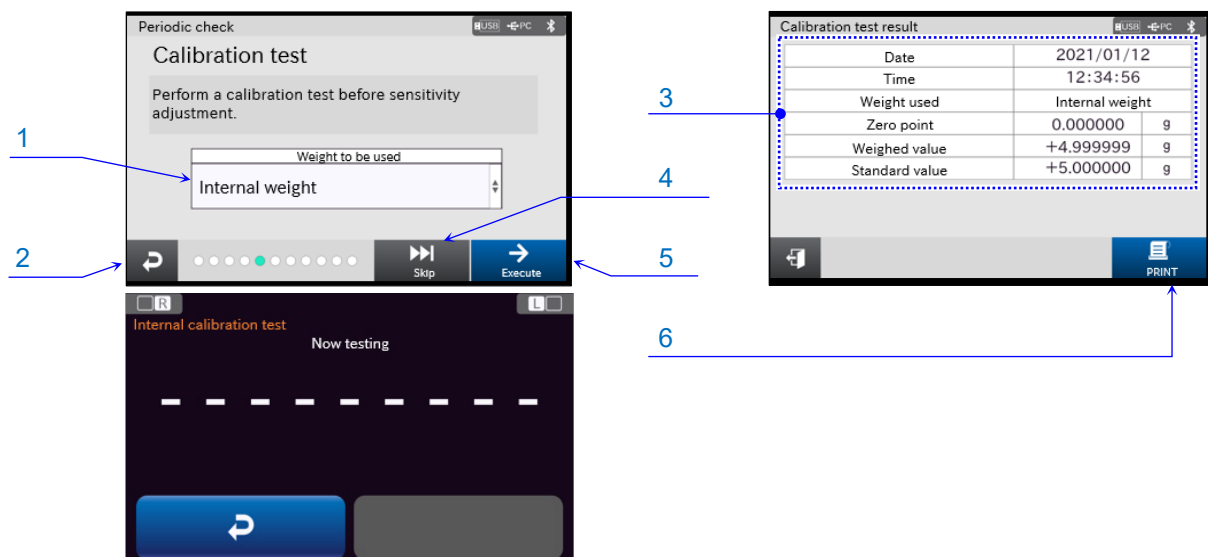

	Name	Setting value (setting range)	Description
1	Weight to be used	Internal weight , External weight	Select the weight to be used.
2	Back button	-	Cancels and returns to the previous screen.
3	Result display	—	Displays the calibration test result.
4	Skip button	—	Skips this check item and proceeds to the next item.
5	Execute button	—	Executes the calibration test.
6	PRINT button		Outputs the results to the device connected to the balance. The results are automatically output if [GLP output] in [Data output] is set to ON.

 Settings in the red box are default values (factory settings).

6. Sensitivity Adjustment

The sensitivity adjustment is performed. When the adjustment is complete, the [Sensitivity adjustment result] screen is automatically displayed.

Be sure to warm up the balance with nothing on the weighing pan for at least an hour, or at least four hours for BA-6TE/BA-6DTE, with the AC adapter connected to the power supply.

When the internal weight is used, this is automatically performed. When an external weight is used, follow the instruction.

Do not apply vibration and the like to the balance during sensitivity adjustment.

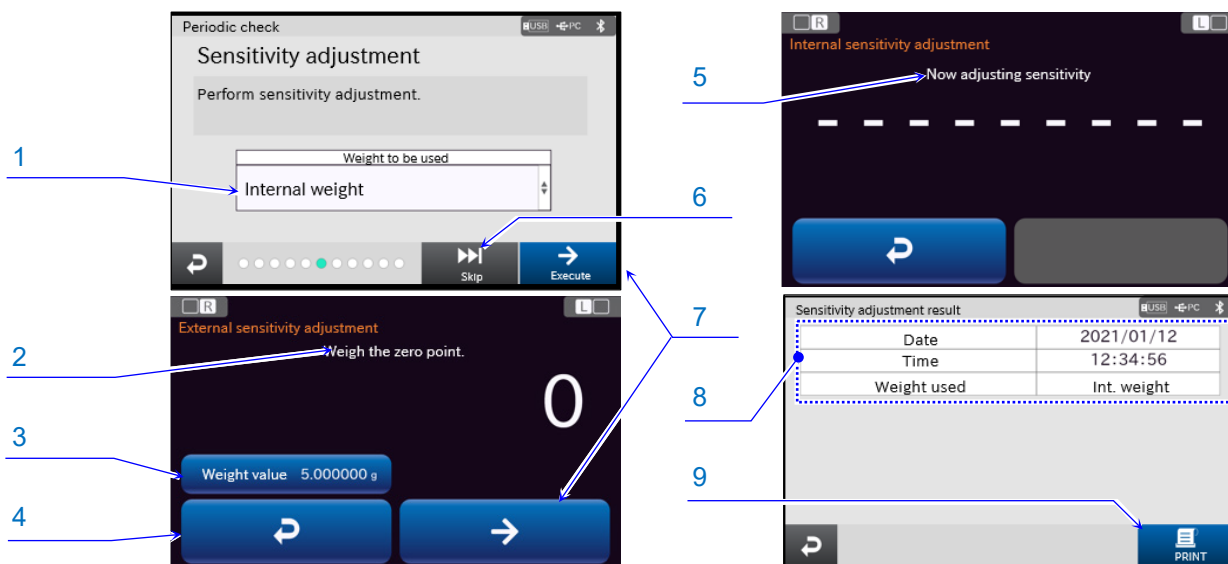

	Name	Setting value (setting range)	Description
1	Weight to be used	Internal weight, External weight	Select the weight to be used.
2	Instruction display	—	Displays the instruction for external sensitivity adjustment.
3	External weight value input	Input range *1	Input the external weight value. This is common to the external weight value input field in the [Sensitivity adjustment setting] screen.
4	[Back] button	-	Cancels and returns to the previous screen.
5	Instruction display	—	Displays the progress of the internal sensitivity adjustment.
6	[Skip] button	—	Skips this check item and proceeds to the next item.
7	[Execute] button	—	Executes the sensitivity adjustment.
8	Result display	—	Displays the sensitivity adjustment result.
9	[PRINT] button		Outputs the results to the device connected to the balance. The results are automatically output if [GLP output] in [Data output] is set to ON.

 Settings in the red box are default values (factory settings).

*1 Input range

BA-6TE/BA-6DTE : 0.9 g ~ 5 g ~ 5.1 g

BA-225TE/BA-225DTE : 9.9 g ~ 200 g ~ 200.1 g

BA-125DTE : 9.9 g ~ 100 g ~ 100.1 g

7. Pre-loading

Select the weight to be used for execution.

For the internal weight, the pre-loading is automatically performed.

For an external weight, the instruction is displayed on the screen.

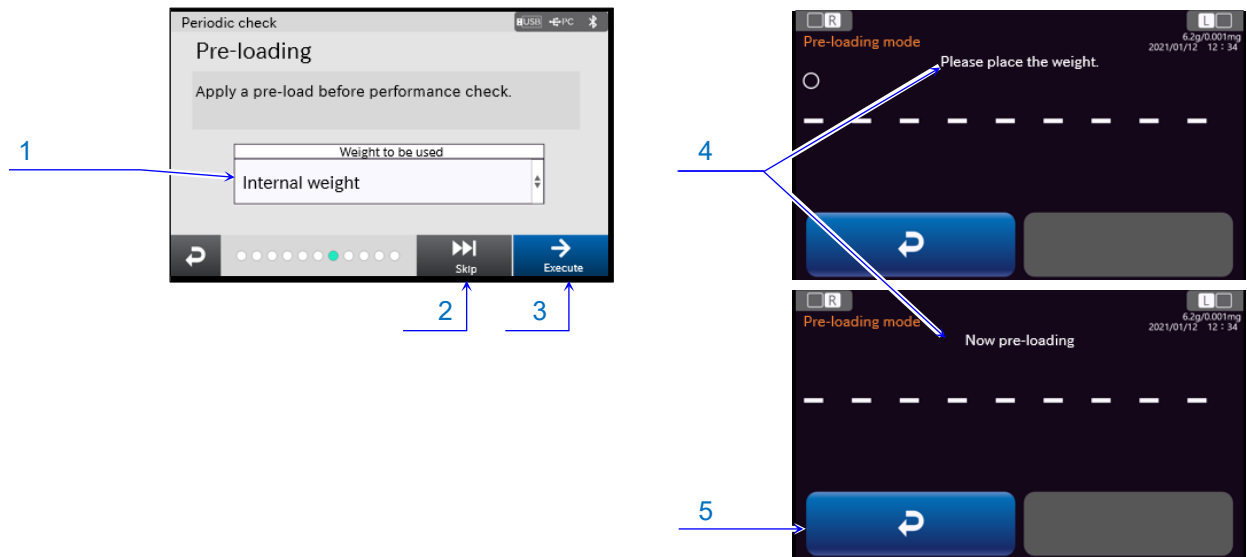

	Name	Setting value (setting range)	Description
1	Weight to be used	Internal weight, External weight	Select the weight to be used.
2	Skip button	-	Skips this check item and proceeds to the next item.
3	Execute button	-	Executes the pre-loading.
4	Instruction display	-	Displays the progress and instruction.
5	Back button	-	Returns to the previous screen.

 Settings in the red box are default values (factory settings).

8. Repeatability

Load and unload the weight multiple times to obtain the standard deviation.

Follow the instruction to load and unload the weight as many times as the specified measurement count.

The setting in the [Repeatability] screen is common to the standard value setting for the daily/periodic check settings.

When the measurement is complete, the [Repeatability measurement result] screen is automatically displayed.

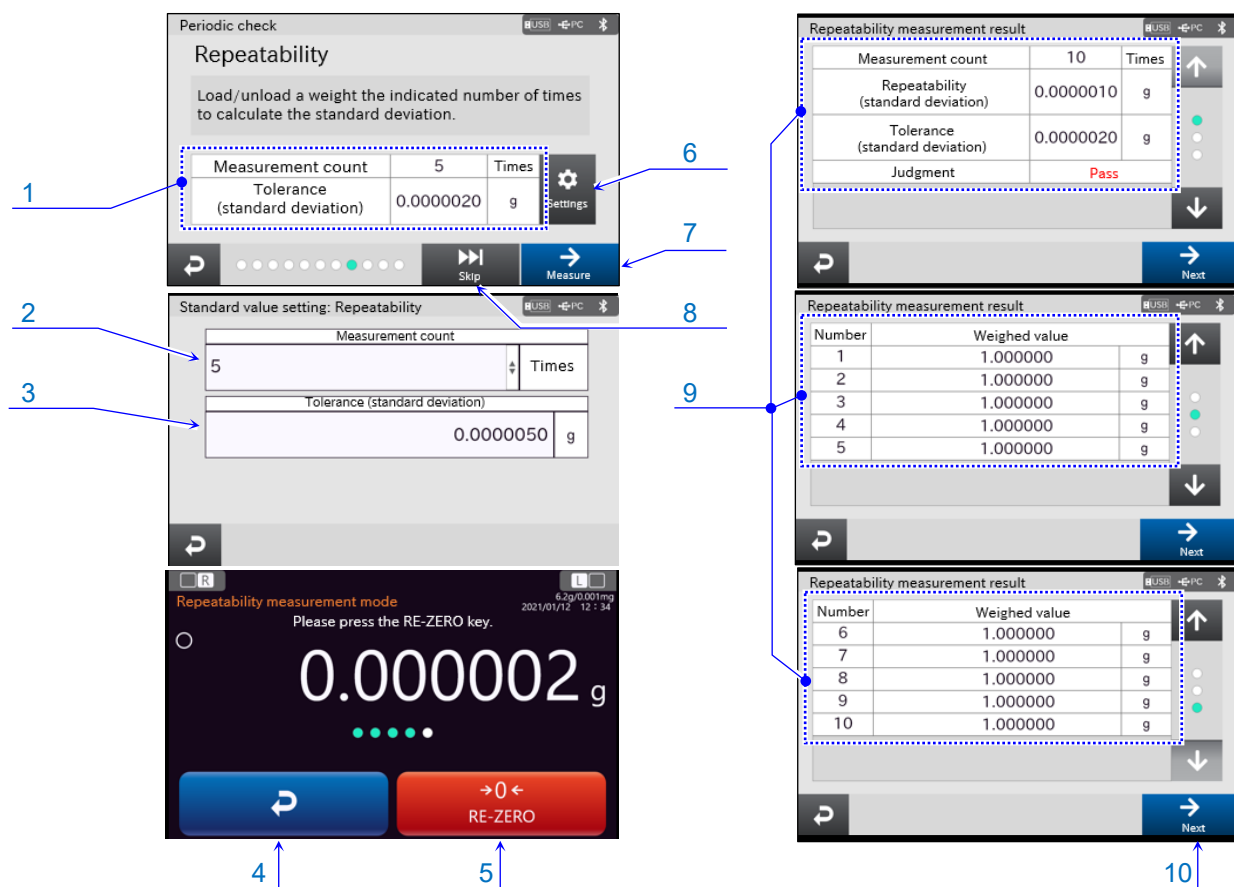

	Name	Description
1	Settings display screen	Displays the set measurement count and tolerance (standard deviation).
2	Measurement count	Set the measurement count. This is common to [11.8.1. Standard value setting: Repeatability].
3	Tolerance (standard deviation)	Set the tolerance (standard deviation). This is common to [11.8.1. Standard value setting: Repeatability].
4	[Back] button	Cancels and returns to the previous screen.
5	[RE-ZERO] button	Sets the displayed value to zero.
6	[Settings] button	Displays the [Standard value setting] screen. Refer to “11.8. Standard value setting”. Set the measurement count and tolerance (standard deviation).
7	[Measure] button	Executes the measurement.
8	[Skip] button	Skips this check item and proceeds to the next item.
9	Repeatability measurement result display	Displays the repeatability measurement result.
10	[Next] button	Proceeds to the next item.

9. Sensitivity Test

The sensitivity test is performed with the selected loading points.

Follow the instruction for measurement operations.

The setting in the [Sensitivity test] screen is common to the standard value setting for the daily/periodic check settings.

When the test is complete, the [Sensitivity test result] screen is automatically displayed.

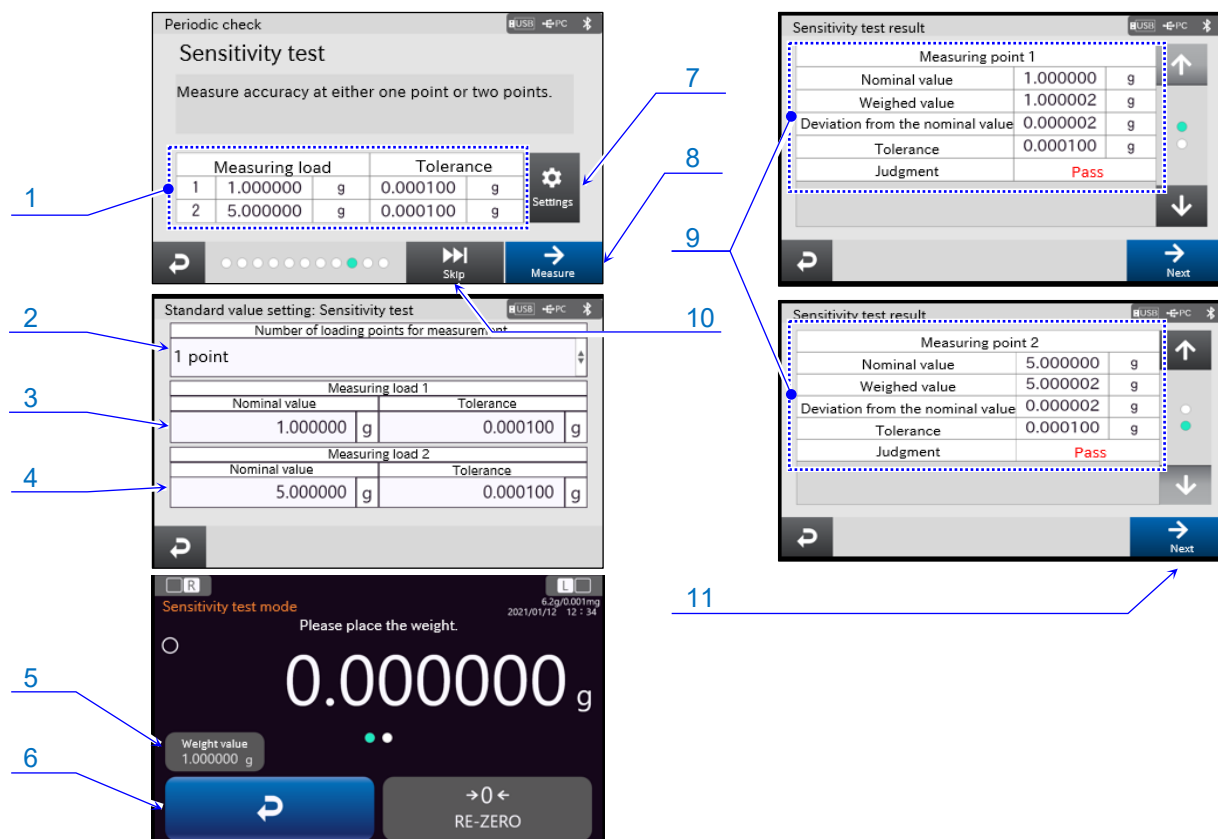

	Name	Setting value (setting range)	Description
1	Settings display screen	—	Displays the set tolerance.
2	Number of loading points for measurement	1 point, 2 points	You can select the number of loading points for measurement.
3	Measuring load 1	—	Displays the nominal value and tolerance.
4	Measuring load 2	—	Displays the nominal value and tolerance.
5	Measuring load display	—	Displays the measuring load.
6	Back button	—	Cancels and returns to the previous screen.
7	Settings button	—	Displays the [Standard value setting] screen. Set the measurement count and tolerance (standard deviation).
8	Measure button	—	Executes the measurement.
9	Sensitivity test result display	—	Displays the sensitivity test result.
10	Skip button	—	Skips this check item and proceeds to the next item.
11	Next button	—	Proceeds to the next item.

Settings in the red box are default values (factory settings).

10. Eccentricity

The eccentricity is measured.

Follow the instruction for measurement.

The setting in the [Sensitivity test] screen is common to the standard value setting for the daily/periodic check settings.

When the measurement is complete, the [Eccentricity measurement result] screen is automatically displayed.

The accurate positions for measurement positions 2, 3, 4 and 5 are at the 1/4 position of the diagonal line or diameter of the weighing pan.

It is advisable to use a weight approx. 1/3 as heavy as the capacity of the balance.

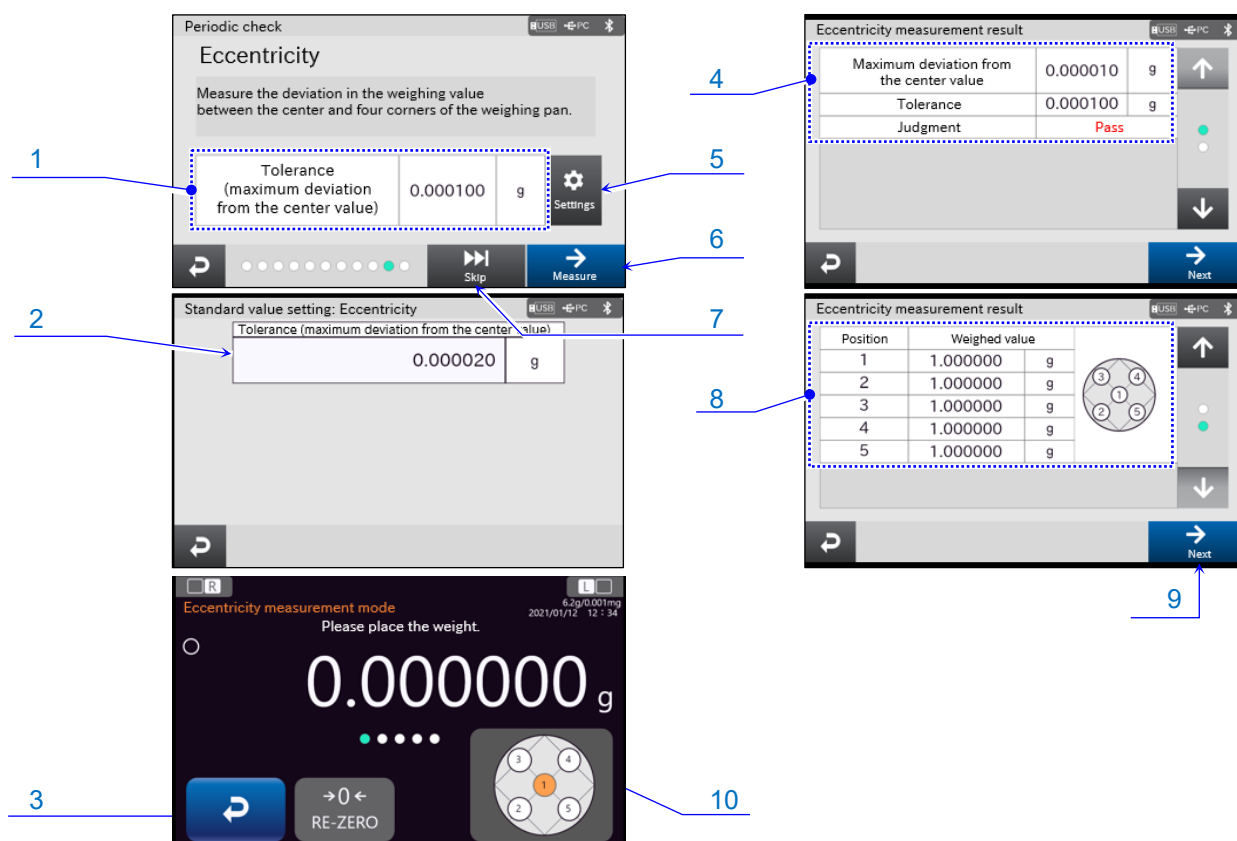

	Name	Description
1	Settings display screen	Displays the set tolerance (maximum deviation from the center value).
2	Tolerance (maximum deviation from the center value)	Set the tolerance for eccentricity.
3	[Back] button	Cancels and returns to the previous screen.
4	Eccentricity measurement result display	Cancels the eccentricity measurement and returns to the previous screen.
5	[Settings] button	Displays the [Standard value setting] screen. Configure the set tolerance (maximum deviation from the center value).
6	[Measure] button	Executes the measurement.
7	[Skip] button	Skips this check item and proceeds to the next item.
8	Weighing value	Displays the measurement positions and weighing values.
9	[Next] button	Proceeds to the next item.
10	Weight position image	Displays the positions where the weight is placed during measurement.

11. Periodic check results

The results of all periodic check items are displayed.

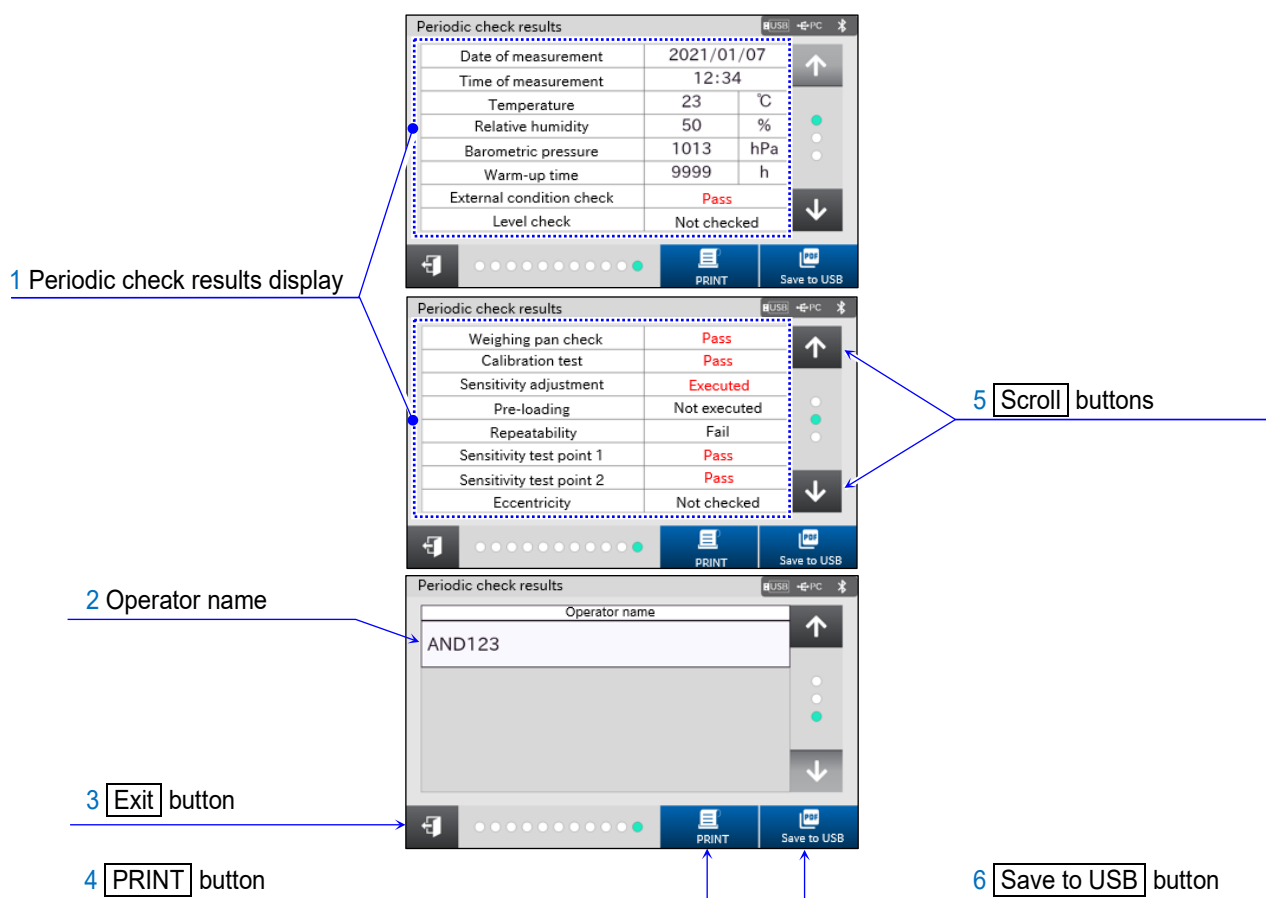

	Name	Description
1	Periodic check results display	Shows the results of the periodic check.
2	Operator name	Displays the name of the user that performed the periodic check. You can enter the name.
3	Exit button	Exits the screen that shows the results of the periodic check.
4	PRINT button	Outputs the periodic check results to the device connected to the balance.
5	Scroll buttons	Select the page.
6	Save to USB button	Outputs PDF data containing the periodic check results to the USB flash drive connected to the balance.

11.2.1. Output example for periodic check output results

Periodic check output results

```

-PERIODIC CHECK-

                A & D
MODEL          BA-6TE
S/N           123456789
ID LAB-012345678
DATE          2021/01/23
TIME          12:34:56

TEMP           25  C
HR             50  %
BAR            1000hPa
WARM UP        1  h

EXT.CONDITION

LEVEL CHECK    OK

WEIGHING PAN   OK

CAL.TEST<INT>
ACTUAL         0.000000  g
               +4.999999  g
TARGET        +5.000000  g

PRELOAD        OK

REPEATABILITY
1  1.000000  g
2  1.000000  g
3  1.000001  g
4  1.000000  g
5  1.000001  g
6  1.000000  g
7  1.000000  g
8  1.000000  g
9  0.999999  g
10 1.000000  g

S.D.           0.0000006  g
SPEC.         0.0000050  g
JUDGEMENT     OK

SENSITIVITY TEST
    
```

```

SENSITIVITY TEST
SETTING
    1.000000  g
MEASURED
    0.999999  g
JUDGEMENT    OK

SETTING
- - - - -  g
MEASURED
- - - - -  g
SPEC.
- - - - -  g
JUDGEMENT    **

ECCENTRICITY ERR
1  5.000000  g
2  4.999995  g
3  5.000001  g
4  5.000004  g

MAX. DIFFERENCE
-0.000005  g
SPEC.
0.000020  g
JUDGEMENT    OK

REMARKS

SIGNATURE

-----
    
```

Periodic check results (PDF)

Periodic Balance Check Report



Date : 01/01/2021 12:00:00 Last check date : 12/01/2020 12:00:00
 Location :
 Weight used :

1. Balance

Model : BA-6TE Capacity : 6.2g Readability : 0.001mg
 Serial No. : 123456789 ID No. : LAB-012345678

2. Environmental conditions

Temperature : 25 °C Relative humidity : 50 %
 Barometric Pressure : 1000 hPa Warm-up time : 1 h

3. Check items

3-1. Ext. condition check : Pass 3-2. Level check : Pass
 3-3. Weighing pan check : Pass

4. Performance check

4-1. Calibration test : Executed

Weight used	Int. weight	Std value	5.000000 g	Weighed value	4.999999 g
-------------	-------------	-----------	------------	---------------	------------

4-2. Sensitivity adjustment : Executed

Weight used	Int. weight	Std value	5.000000 g
-------------	-------------	-----------	------------

4-3. Pre-loading : Executed

4-4. Repeatability : Pass

No.	1	2	3	4	5
Weighed value	1.000000 g	1.000000 g	1.000001 g	1.000000 g	1.000001 g
No.	6	7	8	9	10
Weighed value	1.000000 g	1.000000 g	1.000000 g	0.999999 g	1.000000 g
Std deviation	0.0000006 g	Judgment	0.0000050 g		

4-5. Sensitivity test Point 1 : Pass Point 2 : Not checked

Point	Nominal value	Weighed value	Deviation	Judgment
1	1.000000 g	0.999999 g	0.000001 g	0.000100 g
2	----- g	----- g	----- g	----- g

4-6. Eccentricity : Pass

Position	1	2	3
Weighed value	5.000000 g	4.999995 g	5.000001 g
Position	4	5	
Weighed value	5.000004 g	4.999999 g	
Max deviation from center	-0.000005 g	Judgment	0.000010 g

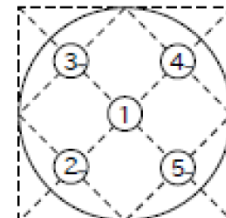

5. Remarks

Signature (Operator) _____

Signature (Manager) _____

11.3. Repeatability check

Display settings: **MENU** key **Calibration test/check** button →
Repeatability check button **S.D.** → [Repeatability measurement] screen

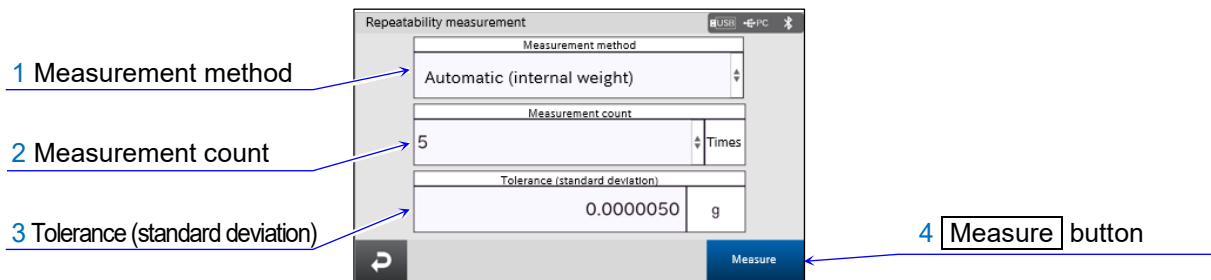

	Name	Setting value (setting range)	Description
1	Measurement method	Automatic (internal weight) , Manual (external weight)	Select the measurement method.
2	Measurement count	-	Displays the measurement count.
3	Tolerance (standard deviation)	-	Displays the tolerance (standard deviation).
4	Measure button	-	Executes the measurement.
5	Back button	-	Returns to the previous screen.

 Settings in the red box are default values (factory settings).

- For the internal weight, the repeatability check is automatically performed.
For an external weight, follow the instruction.
When the measurement is complete, [Repeatability measurement result] is automatically displayed.
- This is common to the [Quick performance check: Repeatability measurement] screen described in "6. Quick performance check: [Repeatability Measurement] Screen".

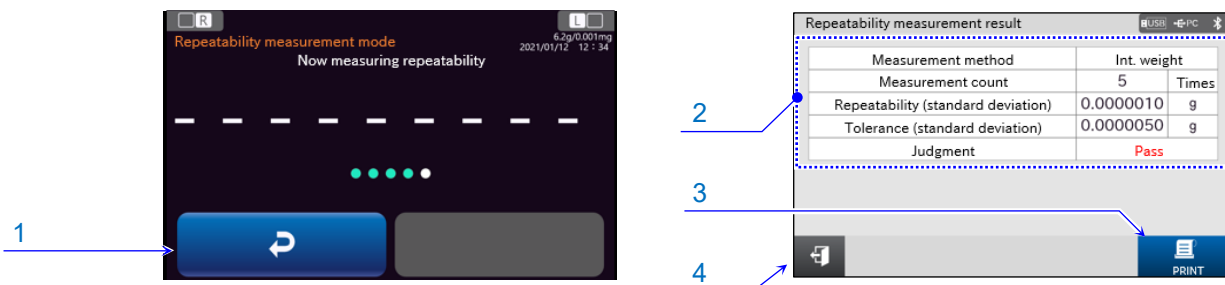

11.3.1. Repeatability measurement with the internal weight

Display settings: **MENU** key **MENU** → **Calibration test/check** button **Measure** →
Repeatability check button **S.D.** → [Repeatability measurement] screen. In this screen,
with [Automatic (internal weight)] selected for the measurement method, select
Measure button **Measure** → [Repeatability measurement] screen with the internal weight



	Name	Description
1	Back button	Returns to the previous screen.
2	Repeatability measurement result display	Displays the repeatability measurement result.
3	PRINT button	Outputs the result to the device connected to the balance.
4	Exit button	Exits the screen that shows the repeatability measurement result.

11.3.2. Repeatability measurement with an external weight

Display settings: **MENU** key  → **Calibration test/check** button  →

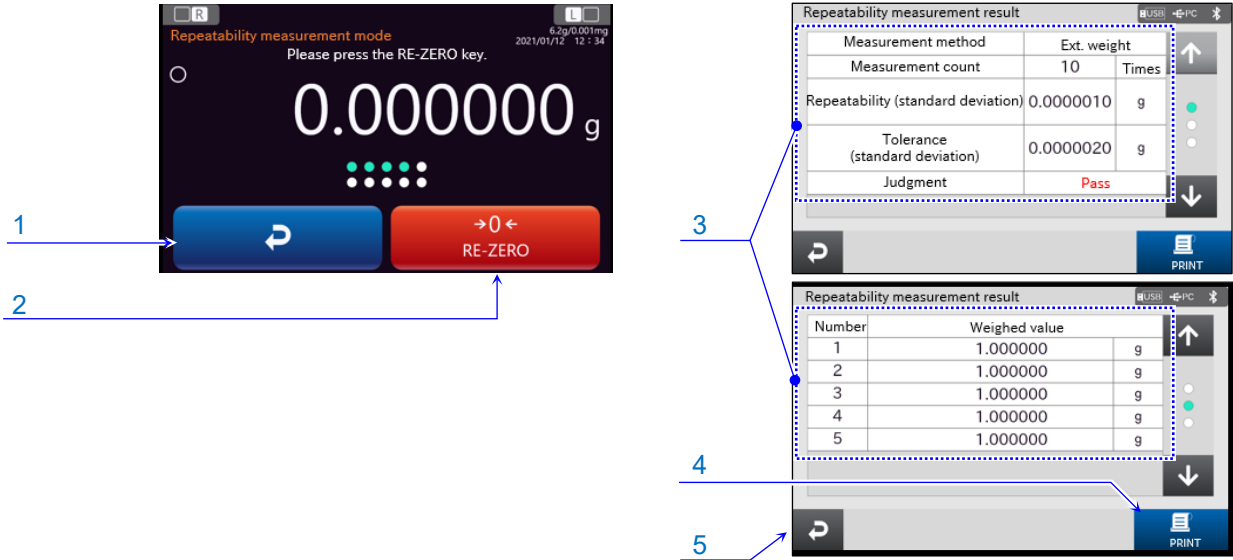

Repeatability check button  → [Repeatability measurement] screen. In this screen, with [Manual (external weight)] selected for the measurement method, select

Measure button  → [Repeatability measurement] screen with an external weight



	Name	Description
1	Back button	Returns to the previous screen.
2	RE-ZERO button	Sets the displayed value to zero.
3	Repeatability measurement result display	Displays the repeatability measurement result.
4	PRINT button	Outputs the result to the device connected to the balance.
5	Exit button	Exits the screen that shows the repeatability measurement result.

11.4. Internal calibration test

Display settings: **MENU** key  → **Calibration test/check** button  → **Internal calibration test** button  → [Calibration test] screen

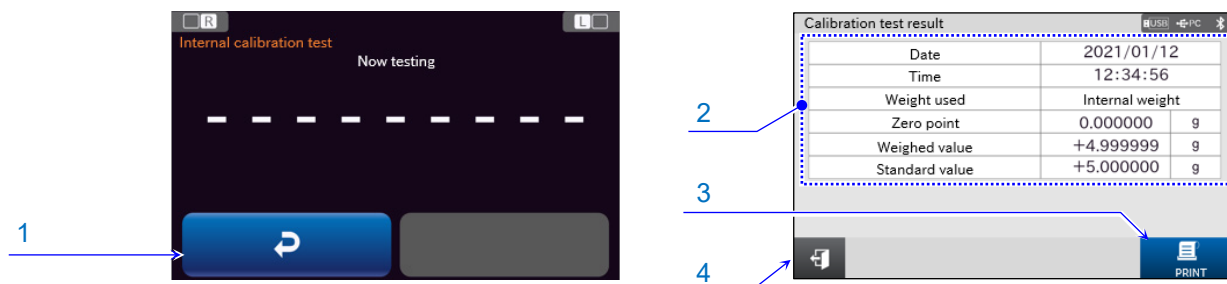



	Name	Description
1	Back button	Returns to the previous screen.
2	Calibration test result display	Displays the measurement result.
3	PRINT button	Outputs the measurement result to the device connected to the balance. The result is automatically output if [GLP output] in [Data output] is set to ON.
4	Exit button	Exits the screen that shows the measurement result.

- The internal weight is used to perform the calibration test.
 - Be sure to warm up the balance with nothing on the weighing pan for at least an hour, or at least four hours for BA-6TE/BA-6DTE, with the AC adapter connected to the power supply.
 - Do not apply vibration and the like to the balance during the calibration test.
 - When the test is completed, the [Calibration test result] screen is displayed.

Caution

- No sensitivity adjustment is performed.

11.5. External calibration test

Display settings: **MENU** key  → **Calibration test/check** button  →

External calibration test button  → [External calibration test] screen

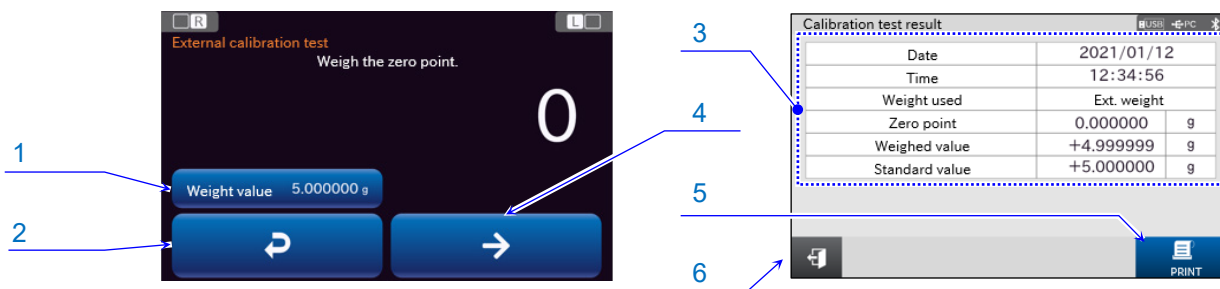

	Name	Description
1	External weight value input	Input the external weight value. Input range: Input range *1 This is common to the external weight value input field in the [Sensitivity adjustment setting] screen.
2	Back button	Returns to the previous screen.
3	Calibration test result display	Displays the measurement result.
4	Confirm button	Confirms the current input setting and proceeds to the next instruction.
5	PRINT button	Outputs the measurement result to the device connected to the balance. The result is automatically output if [GLP output] in [Data output] is set to ON.
6	Exit button	Exits the screen that shows the measurement result.

 Settings in the red box are default values (factory settings).

*1 Input range

BA-6TE/BA-6DTE	: 0.9 g ~ 5 g ~ 5.1 g
BA-225TE/BA-225DTE	: 9.9 g ~ 200 g ~ 200.1 g
BA-125DTE	: 9.9 g ~ 100 g ~ 100.1 g

- Your external weight is used to perform the calibration test.
 - Be sure to warm up the balance with nothing on the weighing pan for at least an hour, or at least four hours for BA-6TE/BA-6DTE, with the AC adapter connected to the power supply.
 - Do not apply vibration and the like to the balance during the calibration test.
 - When the test is completed, the [Calibration test result] screen is displayed.

Caution

- No sensitivity adjustment is performed.

11.6. AND-MEET (with the touch panel software version 1.019 or later)

Display settings: **MENU** key  → **Calibration test/check** button  →
AND-MEET button  → [AND-MEET] screen

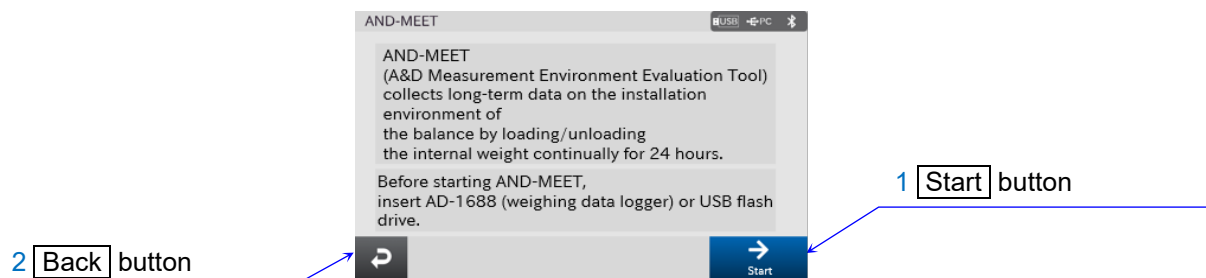

	Name	Description
1	Start button	Starts AND-MEET and displays [AND-MEET] screen.
2	Back button	Returns to the [Calibration test/check] previous screen.

AND-MEET Measurement Environment Evaluation Tool

- ❑ High-sensitivity analytical balances detect minute environmental changes that users cannot detect. This causes the measurement value to be unstable. This is especially so with the BA-6TE/6DTE, a microbalance with a minimum display of 1µg or a semi-microbalance of a minimum display of 10µg. Using these balances, the specified repeatability may not be obtained in many cases, depending on the environment where the balances are installed. Users may feel uneasy when it happens. However, it is not necessarily resolved even if they ask the balance manufacturers for help.
- ❑ AND-MEET constantly monitors the installation environment of the balance while simultaneously loading and unloading the internal weight of the balance automatically over 24 hours. AND-MEET evaluates temperature changes and the corresponding repeatability of measurement data over time. The span value is calculated by subtracting the zero point value from the value obtained when the internal weight is loaded on the balance. Then, the standard deviation of the ten consecutive span values is calculated to obtain the repeatability. The result is presented as a graph for visualization.
- ❑ Time is plotted on the X-axis of the graph. Changes in the zero point, span value, repeatability and temperature are plotted on the Y-axis. Through the graph, interaction between each item (changes in the zero point, span value or repeatability) and environmental changes (time and temperature) can be evaluated.

AND-MEET graph: points to check and measures to take

- ❑ A zero point drift occurs due to changes in the balance internal temperature caused by turning the power on. Warm up the balance until the balance reaches equilibrium with room temperature.
- ❑ Changes in temperature in a day are great:
Use an air conditioner to avoid changes in temperature.
- ❑ Sudden temperature changes occur:
If the causes of the temperature change such as a heat generating device are known, eliminate the causes.

-
- The temperature fine fluctuation occurs:
The air from the air conditioner may be blown directly to the balance. Use a breeze break or change the balance installation site to avoid the direct airflow to the balance from the air conditioner.
 - The repeatability is bad even if changes in temperature are small:
The air from the air conditioner may be strong. Use a breeze break to avoid the direct airflow to the balance from the air conditioner. Sources of vibration may exist near the balance.
 - The repeatability during the day is bad while the repeatability at midnight is good:
Human activities such as opening or closing the door, passing near the balance may influence the balance. Take appropriate measures to avoid passing near the balance while the balance is in use.
 - Temporal poor repeatability:
Impact may have been applied to the balance or table on which the balance is installed. Or an earthquake may have occurred.
 - Others:
Sudden changes in barometric pressure due to typhoon or building vibrations due to strong winds will influence the balance.

Environment to install a microbalance

- Location
The best location is the first floor of the rigid building built on solid ground. Locations along the coast or main roads may be influenced by winds and vibrations.
- Room
Corners of the rooms or areas near a pillar, far from the passage, door or air conditioner outlet and where there is no direct sunlight. A weighing table should be solid and made of stone or wood having low heat conductivity.
- Temperature / barometric pressure / static electricity
Changes in temperature in a day: within 4°C
Changes in temperature in a short time: within 0.2°C/30 minutes
Changes in barometric pressure in a day: within 10 hPa
Static electricity: active elimination is required especially for the balance with a minimum display of 1 mg or less which is more prone to static electricity.

11.6.1. [AND-MEET weighing] screen

Display settings: MENU key → Calibration test/check button → AND-MEET button → Start button → [AND-MEET] screen

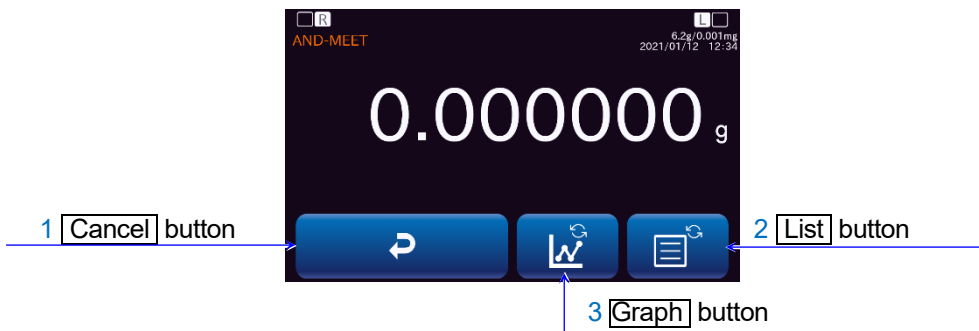

	Name	Description
1	Cancel button	Cancels AND-MEET and displays the [AND-MEET result] screen.
2	List button	Displays the [AND-MEET result list] screen.
3	Graph button	Displays the [AND-MEET graph] screen.

11.6.2. [AND-MEET graph] screen

Display settings: MENU key → Calibration test/check button → AND-MEET button → Start button → Graph button → [AND-MEET graph] screen

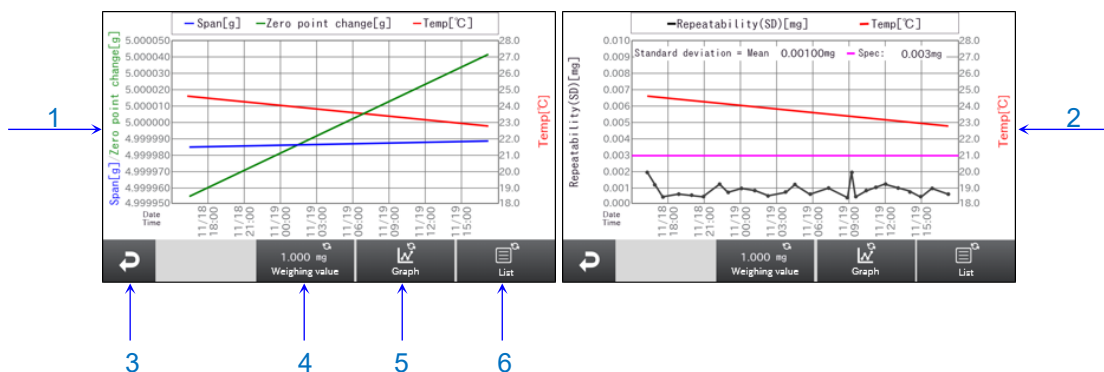

	Name	Description
1	Span/zero point change graph	Displays a span/zero point change graph. Time is plotted on the X-axis. Span/zero point change is plotted on the Y-axis 1. Temperature is plotted on the Y-axis 2.
2	Repeatability graph	Displays a repeatability graph. Time is plotted on the X-axis. Repeatability (standard deviation) is plotted on the Y-axis 1. Temperature is plotted on the Y-axis 2.
3	Cancel button	Cancels AND-MEET and displays the [AND-MEET result] screen.
4	Weighing value button	Displays the [AND-MEET] screen.
5	Graph button	Switches the zero point/span/temperature graph and the repeatability/temperature graph.
6	List button	Displays the [AND-MEET result list] screen.

11.6.3. Description of a graph: temperature/zero point change/span

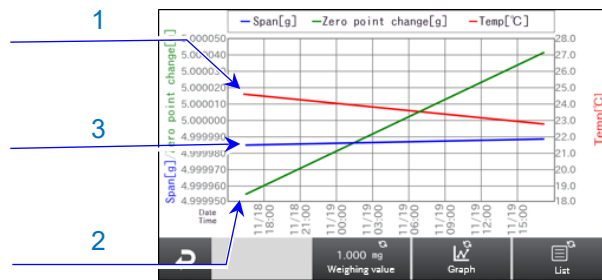



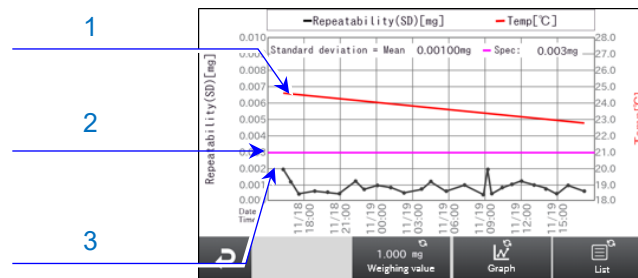

	Name	Description
1	Temperature (red)	Indicates the temperature. The temperature scale is on the right side of the Y-axis.
2	Zero point change (green)	Indicates the changes in zero point. Although the actual value is near zero, the value in the graph has the offset value as large as the span value added to plot on the same graph with the span value. The zero point scale is on the left side of the Y-axis.
3	Span (blue)	Indicates the span value, the value obtained by subtracting the zero value from the value displayed when the internal weight is loaded. The span scale is on the left side of the Y-axis.

11.6.4. Description of a graph: temperature/repeatability



	Name	Description
1	Temperature (red)	Indicates the temperature. The temperature scale is on the right side of the Y-axis.
2	Spec. (pink)	Reference line (standard deviation) for repeatability specified in the brochure. The spec scale is on the left side of the Y-axis.
3	Repeatability (black)	Indicates the standard deviation of ten span values. The repeatability scale is on the left side of the Y-axis.

11.6.5. [AND-MEET result list] screen

Display settings: **MENU** key  → **Calibration test/check** button  → **AND-MEET** button  → **Start** button  → **List** button → [AND-MEET list] screen



	Name	Description
1	AND-MEET result table	Displays the temperature, zero point, span, the standard deviation's maximum value, minimum value, range, and average value.
2	Cancel button	Cancels AND-MEET and displays the [AND-MEET result] screen.
3	Scroll button	Selects a screen.
4	Weighing value button	Displays the [AND-MEET] screen.
5	Graph button	Displays the [AND-MEET graph] screen.

11.6.6. [AND-MEET result] screen



	Name	Description
1	AND-MEET status	Displays either 'Exit' or 'Cancel.' Also displays the time to start and exit the AND-MEET.
2	<input type="button" value="Exit"/> button	Exits the AND-MEET.
3	Span/zero point change graph	Refer to "11.6.3 Description of a graph: temperature/zero point change/span".
4	Repeatability graph	Refer to "11.6.4. Description of a graph: temperature/repeatability".
5	AND-MEET result table	Displays the temperature, zero point, span, the standard deviation's maximum value, minimum value, range, and average value.
6	<input type="button" value="Back"/> button	Returns to the previous screen.
7	<input type="button" value="Next"/> button	Transitions to the next page.
8	Location input	Input the measurement location.
9	Operator name	Input the name of user who operates the AND-MEET.
10	<input type="button" value="USB flash drive"/> button	Outputs the PDF data of the AND-MEET result to the USB flash drive.

11.6.7. AND-MEET analysis graph example

AND-MEET Analysis Graph



Start time : 2021/11/18 16:48 End time : 2021/11/19 16:48

Location : a&d

Balance

Model : BA-6DTE Capacity : 2.1g/6.2g Readability : 0.001mg/0.01mg

Serial No. : T2400104 ID No. : 000000000000

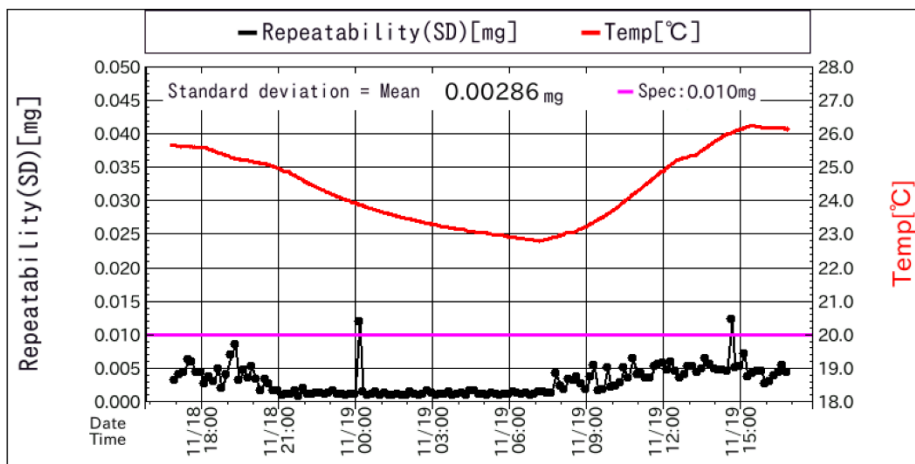
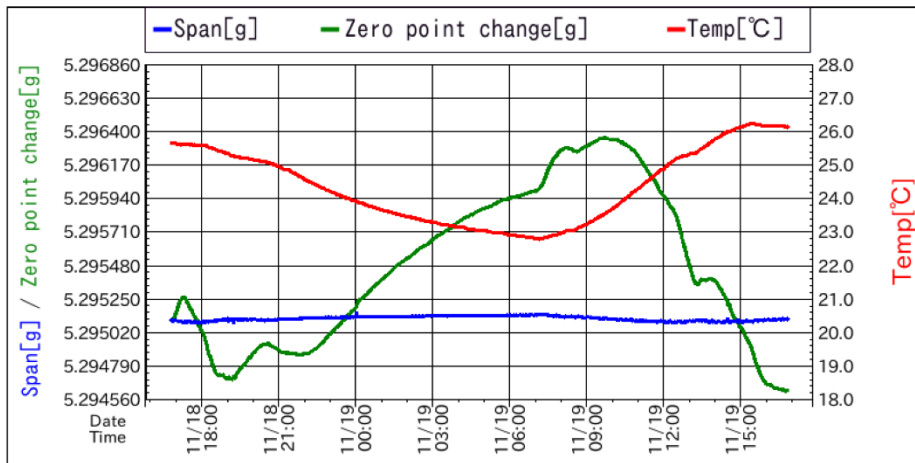



	Maximum	Minimum	Range(Max-Min)	Mean
Temp[C]	26.25	22.79	3.46	24.36
Zero[g]	0.001246	-0.000495	0.001741	0.000367
Span[g]	5.295164	5.295072	0.000092	5.295117
Std deviation[mg]	0.01217	0.00063	0.01153	0.00286

Remarks

Signature (Operator) A&D

Signature (Manager)

11.7. Daily/periodic check settings

Display settings: [MENU] key  → [Calibration test/check] button  → [Settings] button  → [Daily/periodic check settings] screen

1 [Standard value setting] button

2 [Daily/periodic check reminder] button



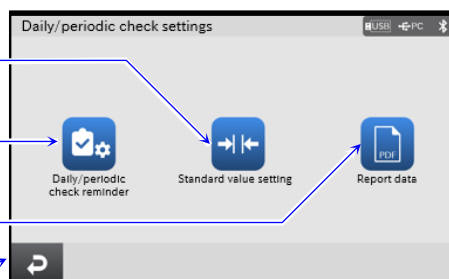

3 [Report data] button

4 [Back] button



	Name	Description
1	[Standard value setting] button	Displays the [Standard value setting] screen.
2	[Daily/periodic check reminder] button	Displays the [Daily/periodic check reminder] screen.
3	[Report data] button	Displays the [Report data] screen.
4	[Back] button	Returns to the previous screen.

11.8. Daily/periodic check reminder

Display settings: [MENU] key  → [Calibration test/check] button  → [Settings] button  → [Daily/periodic check reminder] button  → [Daily/periodic check reminder] screen

1 Daily check reminder before the start of weighing

2 Periodic check reminder

3 Periodic check cycle

4 Last periodic check date

5 [Back] button

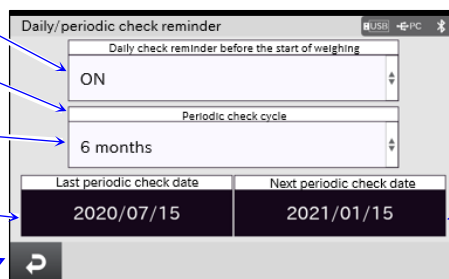





6 Next periodic check date

	Name	Setting value (setting range)	Description
1	Daily check reminder before the start of weighing	OFF, ON	Sets the daily check reminder before the start of weighing.
2	Periodic check reminder	OFF , ON	Select whether to send the periodic check reminder.
3	Periodic check cycle	1 month, 6 months , 1 year, 2 years	Select the periodic check cycle.
4	Last periodic check date	-	Displays the last periodic check date.
5	[Back] button	-	Returns to the previous screen.
6	Next periodic check date	-	Displays the next periodic check date.

Settings in the red box are default values (factory settings).

11.8.1. Startup screen when the daily check reminder is set to ON



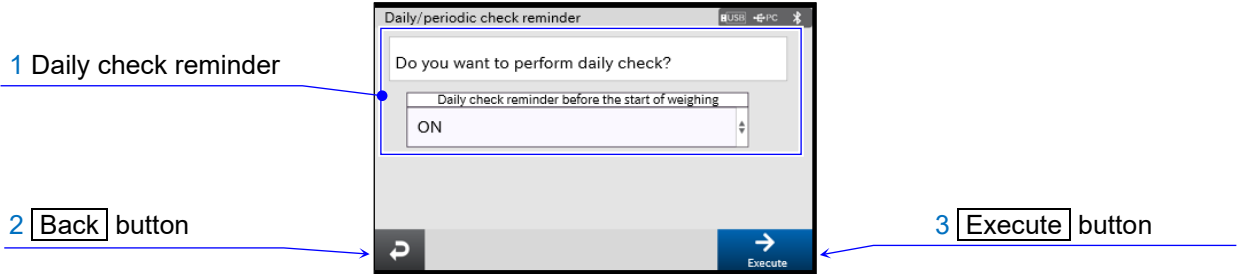

Display settings: **MENU** key  → **Calibration test/check** button  → **Settings** button  → **Daily/periodic check reminder** button  → **Daily check reminder before the start of weighing** button → Select [ON]

Use the **ON:OFF** key  to turn on the display → [Daily/periodic check reminder] screen for daily check



	Name	Description
1	Daily check reminder	Displayed at startup if [Daily check reminder before the start of weighing] is set to ON.
2	Back button	Cancels the check and returns to the HOME screen.
3	Execute button	Executes the check.

11.8.2. Startup screen when the periodic check reminder is set to ON



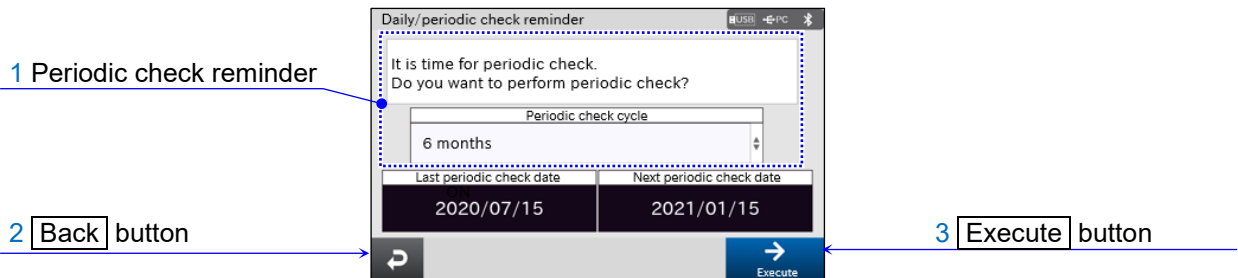

Display settings: **MENU** key  → **Calibration test/check** button  → **Settings** button  → **Daily/periodic check reminder** button  → **Periodic check reminder** button → Select [ON]

Use the **ON:OFF** key  to turn on the display → [Daily/periodic check reminder] screen for periodic check



	Name	Description
1	Periodic check reminder	Displayed at startup if the periodic check reminder is set to ON.
2	Back button	Cancels the check and returns to the HOME screen.
3	Execute button	Executes the check.



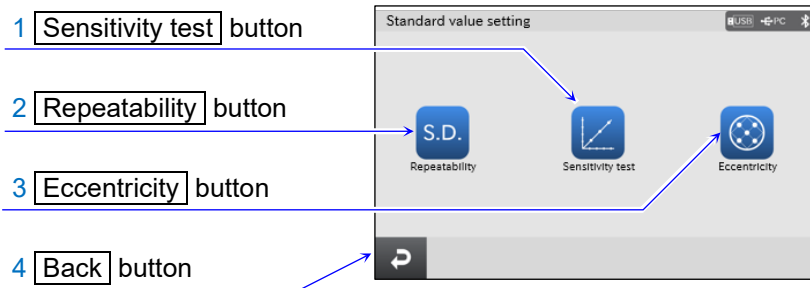

11.9. Standard value setting

Display settings: [MENU] key  → [Calibration test/check] button  → [Settings] button  → [Standard value setting] button  → [Standard value setting] screen



	Name	Description
1	[Sensitivity test] button	Displays the [Standard value setting: Sensitivity test] screen.
2	[Repeatability] button	Displays the [Standard value setting: Repeatability] screen.
3	[Eccentricity] button	Displays the [Standard value setting: Eccentricity] screen.
4	[Back] button	Returns to the previous screen.

11.9.1. Standard value setting: Repeatability



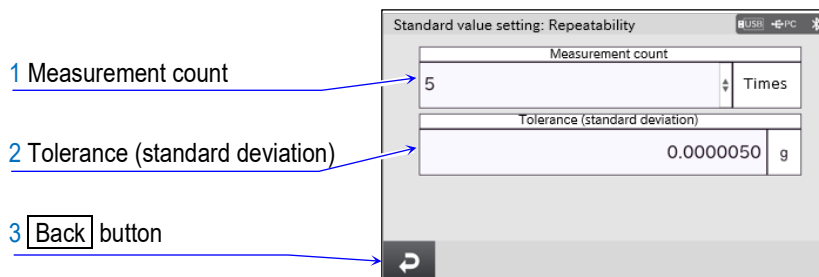

Display settings: [MENU] key  → [Calibration test/check] button  → [Settings] button  → [Standard value setting] button  → [Repeatability] button  → [Standard value setting: Repeatability] screen



	Name	Description
1	Measurement count	Set the measurement count.
2	Tolerance (standard deviation)	Set the tolerance (standard deviation).
3	[Back] button	Returns to the previous screen.

- You can change the repeatability settings.
The settings in this screen are common to the repeatability settings screen for the periodic check.

11.9.2. Standard value setting: Sensitivity test

Display settings: MENU key  → Calibration test/check button  → Settings button  → Standard value setting button  → Sensitivity test button  → [Standard value setting: Sensitivity test] screen

1 Number of loading points for measurement

2 Measuring load 1

3 Measuring load 2

4 Back button

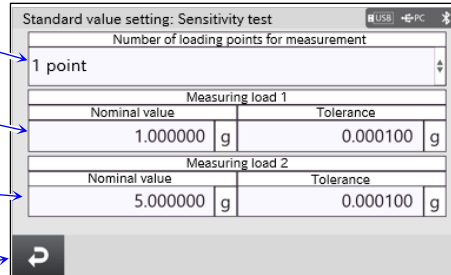





	Name	Setting value (setting range)	Description
1	Number of loading points for measurement	2 point , 1 points	Set the number of loading points for measurement.
2	Measuring load 1	-	Set the nominal value and tolerance.
3	Measuring load 2	-	Set the nominal value and tolerance.
4	Back button	-	Returns to the previous screen.

1 points Settings in the red box are default values (factory settings).

- You can change the sensitivity test settings.
The settings in this screen are common to the sensitivity test settings screen for the periodic check.

11.9.3. Standard value setting: Eccentricity

Display settings: MENU key  → Calibration test/check button  → Settings button  → Standard value setting button  → Eccentricity button  → [Standard value setting: Eccentricity] screen

1 Tolerance (maximum deviation from the center value)



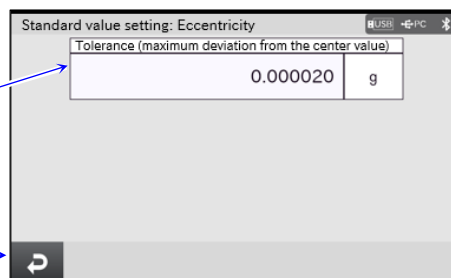

2 Back button



	Name	Description
1	Tolerance (maximum deviation from the center value)	Set the tolerance (maximum deviation from the center value).
2	Back button	Returns to the previous screen.

- You can change the eccentricity settings.
The settings in this screen are common to the eccentricity settings screen for the periodic check.

11.10. Report data

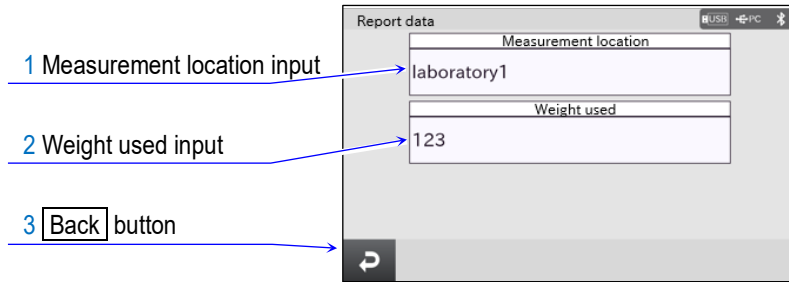

Display settings: MENU key  → Calibration test/check button  → Settings button  → Report data button  → [Report data] screen



	Name	Description
1	Measurement location input	Input the measurement location.
2	Weight used input	Input the weight used.
3	Back button	Returns to the previous screen.

- The [Report data] screen displays the measurement location and weight used.

12. Filter Settings

Display settings: **MENU** key  → **Filter settings** button  → [Filter settings] screen

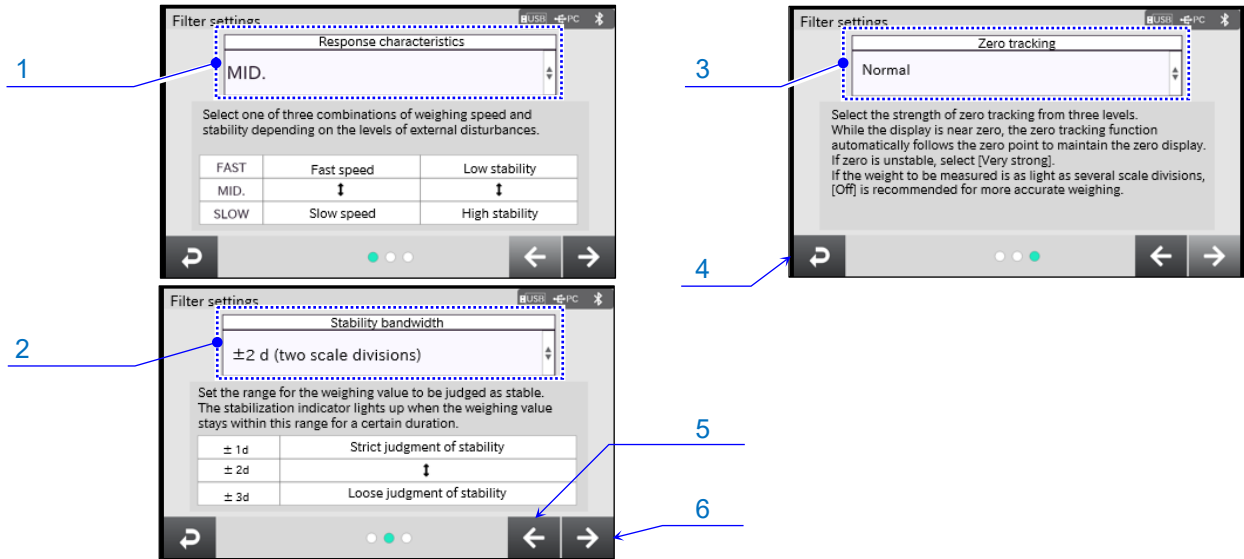

	Name	Setting value (setting range)	Description
1	Response characteristics	FAST, MID. , SLOW	You can set the level of the response to external disturbances that affect the balance.
2	Stability bandwidth	±1 d, ±2 d , ±3 d	Sets the fluctuation range where the stabilization indicator of the weighing value is displayed.
3	Zero tracking	OFF, Normal , Strong, Very strong	Changes the setting of the zero tracking.
4	Back button	-	Returns to the previous screen.
5	Previous button	-	Returns to the previous screen.
6	Next button	-	Transitions to the next screen.

 Settings in a red box are default values (factory settings).

"d" is a unit of readability.

12.1. Commentary on filter settings

Response characteristics

FAST



SLOW

The display shows an acute response to weight variation. Reduce the setting value when weighing powder or liquid, weighing extremely lightweight samples, or prioritizing the operating efficiency over the stability of the weighing value.

The display shows a gradual response to weight variation. Increase the setting value when the weighing value does not get stabilized depending on the usage environment.

Stability bandwidth

The setting to determine that the weighing value is stable. It shows the stabilization indicator when the fluctuation range in a certain time of period gets lower than the setting value, and outputs the weighing value based on the internal settings. This setting affects the automatic printing.

The minimum display to be shown is 1 d.

(Example) If **No blank** is selected with BA-6TE and 0.000001-g display is chosen, 0.000001 g is shown as 1 d.

±1d



±3d

The stabilization indicator does not appear unless the weighing value is stable enough, and it disappears when the weighing values changes even slightly. Reduce the setting value for precise weighing.



The display does not easily respond to a slight weight variation. Increase the setting value when the weighing value does not get stabilized depending on the usage environment.

Zero tracking

The function to automatically track the zero point and keep the zero display when the display shows zero and the zero point slightly fluctuates depending on usage environment. A tracking level can be selected from 3 levels. Increase the setting value if zero is not stabilized. Do not perform zero tracking when the weighing value is slightly over d. d is the minimum unit of the display.

Setting value	BA-6TE / BA-6DTE	BA-225TE / BA-225DTE / BA-125DTE	Description
Off		Off	The zero point is not tracked with zero tracking.
Normal	±2 d/1 second	±1 d/1 second	The zero point is normally tracked with zero tracking.
Strong	±5 d/0.5 seconds	±1.5 d/0.5 seconds	The zero point is strongly tracked with zero tracking.
Very strong	±10 d/0.2 seconds	±1.5 d/0.2 seconds	The zero point is very strongly tracked with zero tracking.

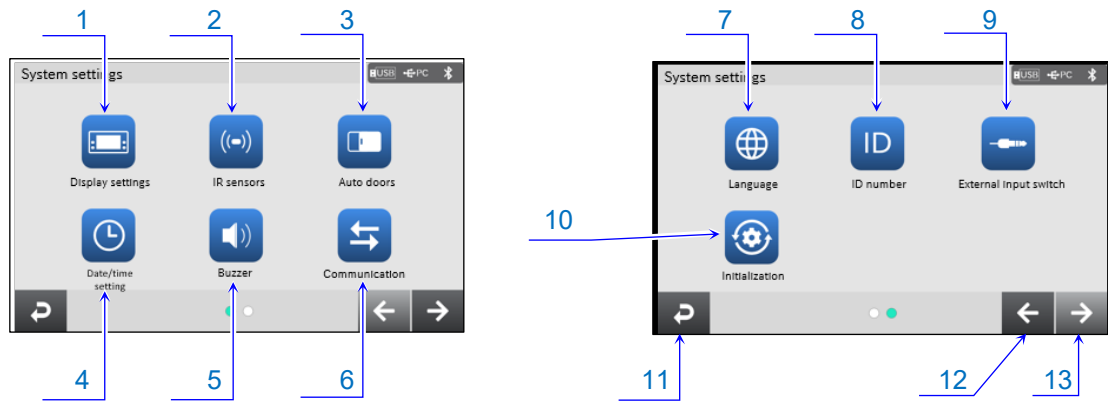

13. System settings

Display settings: **MENU** key  → **System settings** button  → [System settings] screen



	Name	Description
1	Display settings button	Displays the [Display settings] screen.
2	IR sensors button	Displays the [IR sensor] settings screen. You can configure the settings regarding the sensitivity and opening/closing of the breeze break doors for the left and right IR sensors.
3	Auto doors button	Displays the [Auto doors] settings screen. You can configure the settings for the open position of the breeze break doors for the left and right IR sensors.
4	Date/time setting button	Displays the [Date/time setting] screen.
5	Buzzer button	Displays the [Buzzer] settings screen.
6	Communication button	Displays the [Communication] screen. You can configure settings for the output data, connections and communication method.
7	Language button	Displays the [Language] screen.
8	ID number button	Displays the [ID number] settings screen.
9	External input switch button	Displays the [External input switch settings] screen.
10	Initialization button	Resets the various settings for the balance to the factory settings.
11	Back button	Returns to the previous screen.
12	Previous button	Returns to the previous screen.
13	Next button	Transitions to the next screen.

13.1. Display settings

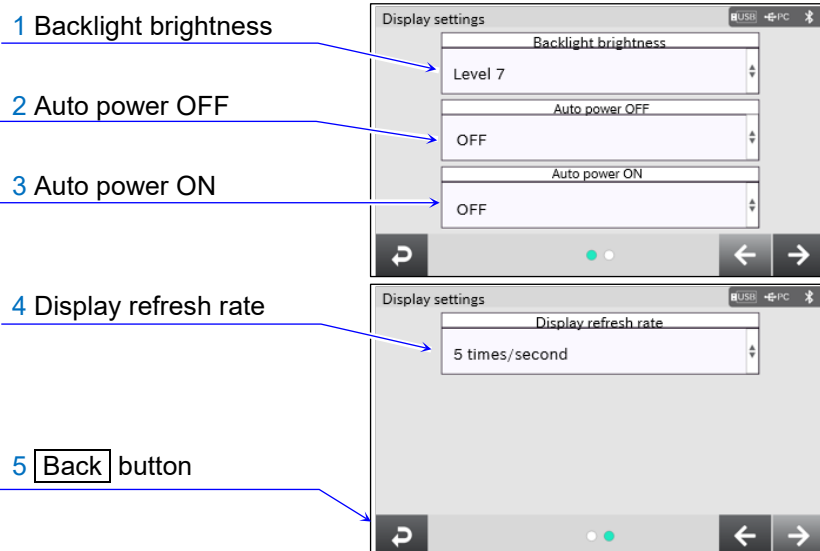

Display settings: [MENU] key  → [System settings] button  → [Display settings] button  → [Display settings] screen



	Name	Setting value (setting range)	Description
1	Backlight brightness	Level 1, Level 2, Level 3, Level 4, Level 5, Level 6, Level 7	Selects the brightness of the backlight of the display.
2	Auto power OFF	OFF , ON (10 minutes)	Turns off the display after 10 minutes has elapsed without any operations.
3	Auto power ON	OFF , ON	This setting turns on the weighing mode display when the AC adapter is connected.
4	Display refresh rate	5 times/second , 10 times/second	Selects the display and output rate. This is common to the setting described in “ 13.8. Data output mode ”.
5	[Back] button	-	Returns to the previous screen.

Settings in the red box are default values (factory settings).

13.2. IR sensors

Display settings: **MENU** key  → **System settings** button  → **IR sensors** button  →
[IR sensor] settings screen

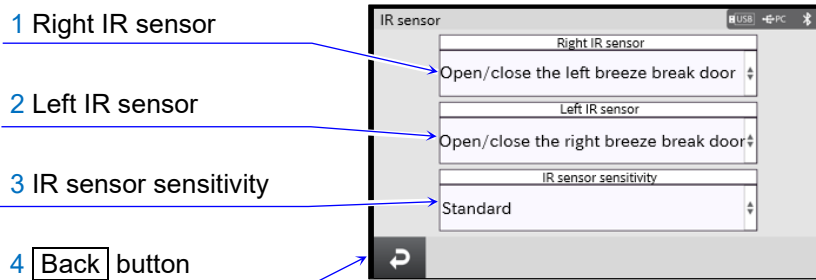



	Name	Setting value (setting range)	Description
1	Right IR sensor	OFF, Open/close the right breeze break door, Open/close the left breeze break door , Open/close both doors*, RE-ZERO, PRINT	Configures the function of the left and right IR sensors.
2	Left IR sensor	OFF, Open/close the right breeze break door , Open/close the left breeze break door, Open/close both doors*, RE-ZERO, PRINT	
3	IR sensor sensitivity	Least sensitive, Standard , Most sensitive	You can select the IR sensor sensitivity.
4	Back button	-	Returns to the previous screen.

Settings in the red box are default values (factory settings).

* Supported with the touch panel software version 1.019 or later

- BA-T series analytical balances are equipped with IR sensors that allow operation without directly touching the balance display.
At factory settings, the IR sensors on the left and right of the display are assigned to open and close the breeze break doors.
You can change the settings for the IR sensors in this device settings screen.

13.3. Breeze break auto doors

Display settings: **MENU** key  → **System settings** button  → **Auto door** button  →
[Auto doors] settings screen

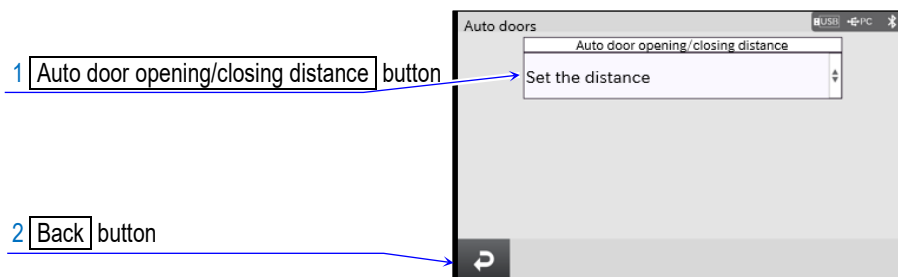



	Name	Setting value (setting range)	Description
1	Auto door opening/closing distance button	Full, Half, Set the distance	Changes the open position of the breeze break.
2	Back button	-	Returns to the previous screen.

Set the distance Settings in the red box are default values (factory settings).

- BA-T series analytical balances are equipped with auto doors that allow you to open/close the breeze break without touching the doors.
The positions of the breeze break auto doors are automatically detected by the IR sensors on the breeze break side surfaces.
At factory settings, the IR sensors on the left and right of the display are assigned to open and close the breeze break doors.
At factory setting, the position each breeze break door was previously opened to is automatically detected.
It is also possible to change the function table of the balance for the doors to be fully open or partially open.

13.4. Date/time setting

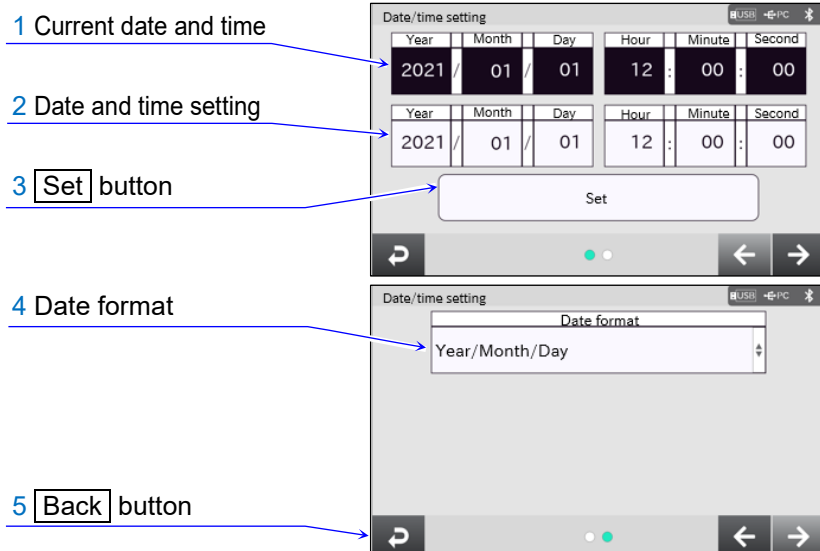

Display settings: **MENU** key  → **System settings** button  → **Date/time** button  → [Date/time setting] screen



	Name	Setting value (setting range)	Description
1	Current date and time	-	Displays the currently set date and time.
2	Date and time setting	-	Input the date and time that you want to set.
3	Set button	-	Changes the settings for the date/time.
4	Date format	Year/Month/Day, Month/Day/Year, Day/Month/Year	Sets the order of the year, month and day.
5	Back button	-	Returns to the previous screen.

- The balance is equipped with a clock and calendar function. When the settings described in “13.9. Data to be added” are set, the time/date can be added to the weighing value output.

13.5. Buzzer

Display settings: **MENU** key  → **System settings** button  → **Buzzer** button  →
[Buzzer] settings screen

1 Buzzer sound

2 **Back** button





	Name	Setting value (setting range)	Description
1	Buzzer sound	OFF, ON	Selects ON/OFF for the built-in buzzer that sounds when a key is operated or the state changes.
2	Back button	-	Returns to the previous screen.

 Settings in the red box are default values (factory settings).

- You can change the setting of the built-in buzzer that sounds when a key is operated or the state changes.



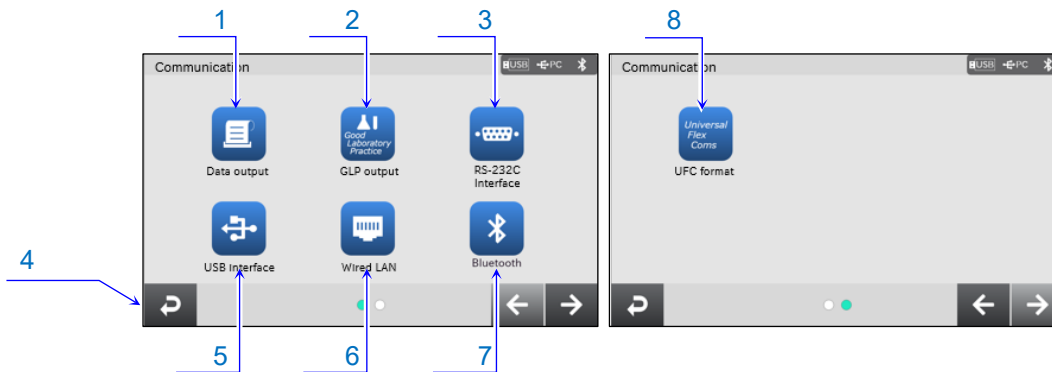

13.6. Communication

Display settings: **MENU** key  → **System settings** button  → **Communication** button  → **[Communication]** screen



	Name	Description
1	Data output button	Displays the [Data output] screen. You can select the output mode and configure the data to be added, output settings and command settings.
2	GLP output button	Displays the [Data output settings] screen. You can configure output settings for the pause between data outputs, auto feed and auto re-zero.
3	RS-232C interface button	Displays the [RS-232C interface] screen.
4	Back button	Returns to the previous screen.
5	USB interface button	Displays the [USB interface] settings screen.
6	Wired LAN button	Displays the [Wired LAN] screen.
7	Bluetooth button	Displays the [Bluetooth] screen.
8	UFC format button	Displays the [UFC format] screen



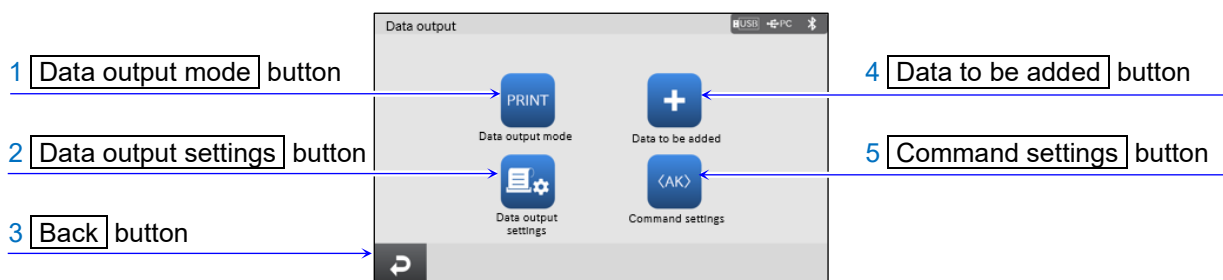

13.7. Data Output

Display settings: **MENU** key  → **System settings** button  → **Communication** button  → **Data output** button  → **[Data output]** screen



	Name	Description
1	Data output mode button	Displays the [Data output mode] screen.
2	Data output settings button	Displays the [Data output settings] screen.
3	Back button	Returns to the previous screen.
4	Data to be added button	Displays the [Data to be added] screen.
5	Command settings button	Displays the [Command settings] settings screen.

13.8. Data output mode

Display settings: **MENU** key  → **System settings** button  → **Communication** button  → **Data output** button  → **Data output mode** button  → [Data output mode] screen

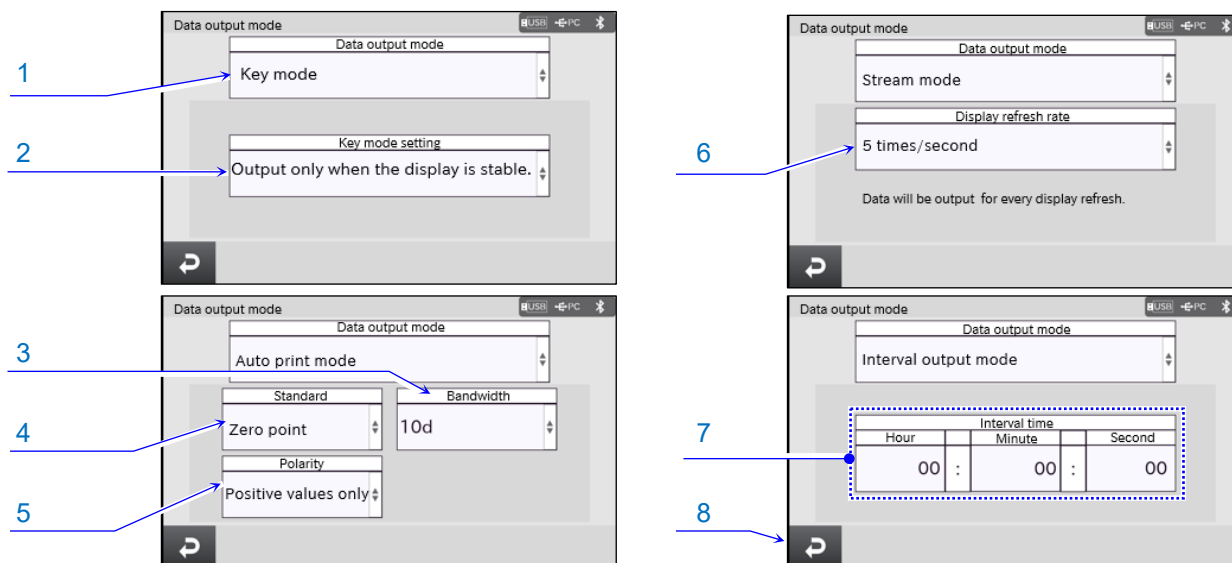





	Name	Setting value (setting range)	Description
1	Data output mode	Key mode , Auto print mode, Stream mode, Interval output mode	Selects the output timing for the selected data.
2	Key mode setting	Output only when the display is stable , Output regardless of whether the display is stable or unstable, Output after the display becomes stable	Selects the output condition for the weighing value.
3	Bandwidth	10 d , 100 d, 1000 d	Selects the auto print bandwidth.
4	Standard	Zero point , Last stable value	Selects the standard for the weighing value.
5	Polarity	Positive values only , Negative values only, Both positive and negative values	Selects the auto print polarity.
6	Display refresh rate	5 times/second , 10 times/second	Selects the display and output rate. This is common to the setting described in "13.1. Display settings".
7	Interval time*	-	Sets the interval time for outputting the weighing value.
8	Back button	-	Returns to the previous screen.

 Settings in the red box are default values (factory settings). "d" is a unit of readability.

- You can change the data output timing for the balance in the [Data output mode] screen.
- * Depending on the interval time and baud rate, all data may not be transmitted unless the baud rate is increased.
- For details about the data output mode, refer to "19.1. Data output mode".

13.9. Data to be added

Display settings: MENU key  → System settings button  → Communication button  → Data output button  → Data to be added button  → [Data to be added] screen

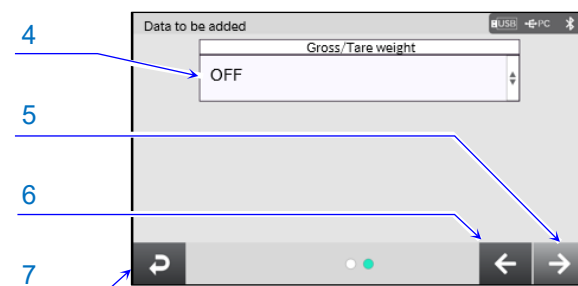
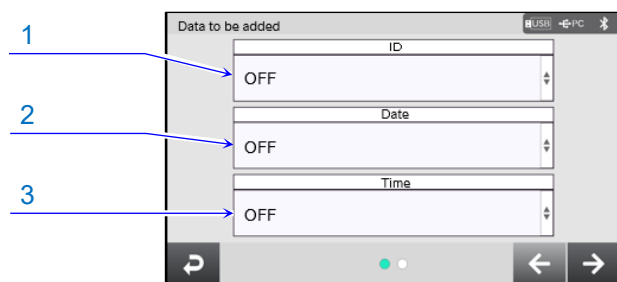





	Name	Setting value (setting range)	Description
1	ID	<input type="checkbox"/> OFF, ON	Whether or not to add ID to the output data.
2	Date	<input type="checkbox"/> OFF, ON	Whether or not to add the date to the output data.
3	Time	<input type="checkbox"/> OFF, ON	Whether or not to add the time to the output data.
4	Gross/Tare weight	<input type="checkbox"/> OFF, Tare weight, Gross weight, Gross weight + Tare weight	Whether to add gross/tare weight, etc. to the output data or not.
5	Next button	-	Transitions to the next screen.
6	Previous button	-	Returns to the previous screen.
7	Back button	-	Returns to the previous screen.

Settings in the red box are default values (factory settings).

You can select to add the ID, date and time to the output data in the [Data to be added] screen.

13.10. Data Output settings



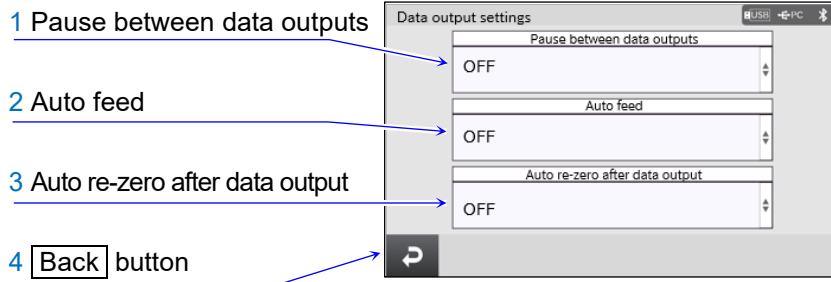

Display settings: **MENU** key  → **System settings** button  →
Communication button  → **Data output** button  →
Data output settings button  → [Data output settings] screen



	Name	Setting value (setting range)	Description
1	Pause between data outputs	OFF , 1.6 seconds	Selects the pause between data outputs.
2	Auto feed	OFF , 1 line	Selects the line feed after data output.
3	Auto re-zero after data output	OFF , ON	Sets the function to automatically set to zero after data output.
4	Back button	-	Returns to the previous screen.

Settings in the red box are default values (factory settings).

13.12. GLP output

Display settings: **MENU** key  → **System settings** button  → **Communication** button  → **GLP output** button  → [GLP output] screen

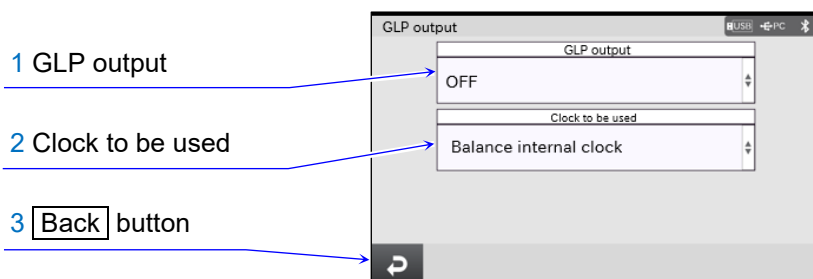

	Name	Setting value (setting range)	Description
1	GLP output	OFF , ON	Change the setting to output GLP.
2	Clock to be used	Balance internal clock , External device clock	Sets the clock for GLP output.
3	Back button	-	Returns to the previous screen.

 Settings in the red box are default values (factory settings).

Main objectives

- The GLP/GMP compliant data can be output to a personal computer or optional printer.
- The GLP/GMP compliant report includes the balance manufacturer (A&D), model name, serial number, ID number, date, time, and space for a signature. For a sensitivity adjustment or calibration test, the result and the weight used are also included.
- The balance can output the following GLP/GMP compliant reports via the connected external output.
- Sensitivity adjustment report (Output for sensitivity adjustment using the internal weight, automatic sensitivity adjustment, sensitivity adjustment using the external weight)
- Calibration test report (Output for calibration test using an internal weight or external weight)
- Breaks ("title block" and "end block") for easy management of a series of weighing data

Output examples of sensitivity adjustment with the internal weight

- The GLP output when the sensitivity of the balance is adjusted using the internal weight is shown below.
- Clock to be used : Balance internal clock. Outputs data with the internal clock of the balance.

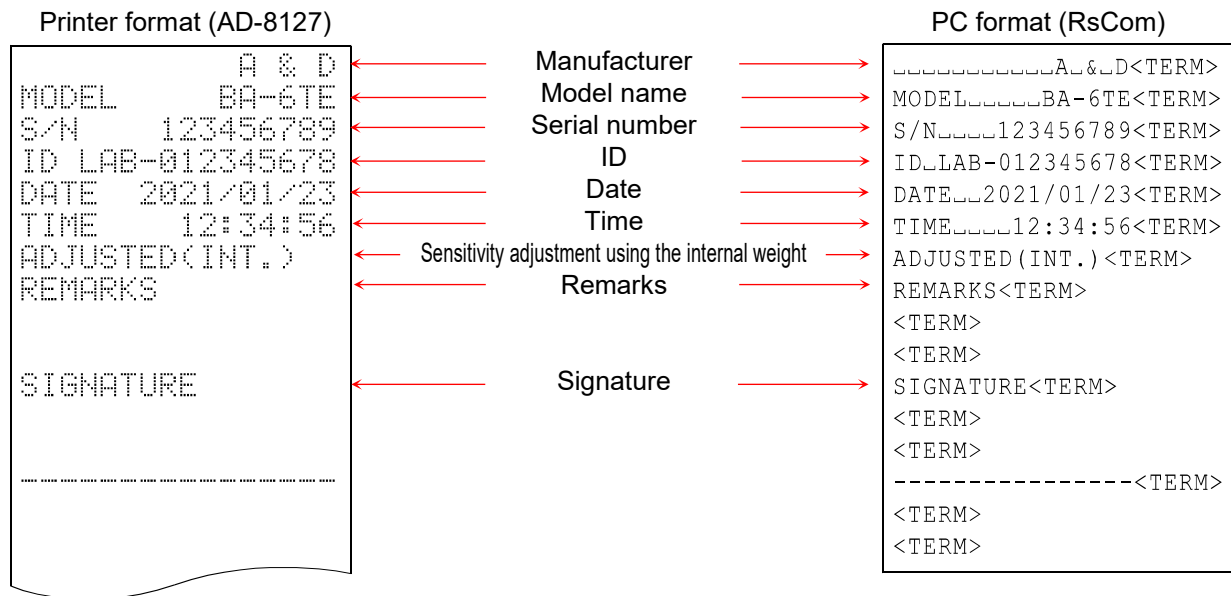

- ␣ : Space, ASCII 20h
- <TERM> : Terminator, CR LF or CR
- CR : Carriage return, ASCII 0Dh
- LF : Line feed, ASCII 0Ah

Outputting external device clock data (clock to be used: external device clock)

- By setting an external device clock for the clock to be used for outputting GLP/GMP data, you can use the clock data from an external device such as a personal computer or printer for the balance instead of the internal clock data. This setting is used to unify the clock data with the clock function of the external device.

Caution

- The clock data output from an external device can be used with a device that has a clock function and that can output the date and time in response to <ESC>D, <ESC>T. (AD-8127 multi-functional compact printer, RsCom [WinCT] data communication software, etc.)

Output examples of calibration test with the internal weight

- The GLP output when the weighing accuracy of the balance is checked using the internal weight is shown below. (Note that sensitivity adjustment is not performed.)
- Clock to be used : Set to [External device clock]. Outputs clock data from an external device clock.

Printer format (AD-8127)		PC format (RsCom)
A & D	Manufacturer	AAAAAAAA&D<TERM>
MODEL BA-6TE	Model name	MODELBA-6TE<TERM>
S/N 123456789	Serial number	S/N123456789<TERM>
ID LAB-012345678	ID	IDLAB-012345678<TERM>
DATE 2021/01/23	Date	2021-05-23<TERM>
TIME 12:34:56	Time	12:34:56<TERM>
CAL. TEST (INT.)	Calibration test	CAL. TEST (INT.) <TERM>
ACTUAL		ACTUAL<TERM>
0.000000 g	Zero point result	0.000000g<TERM>
+4.999999 g	Loaded weight result	+4.999999g<TERM>
TARGET		TARGET<TERM>
+5.000000 g	Target weight used	+5.000000g<TERM>
REMARKS	Remarks	REMARKS<TERM>
		<TERM>
		<TERM>
SIGNATURE	Signature	SIGNATURE<TERM>
		<TERM>
		<TERM>
		-----<TERM>
		<TERM>
		<TERM>

␣ : Space, ASCII 20h

<TERM> : Terminator, CR LF or CR

CR : Carriage return, ASCII 0Dh

LF : Line feed, ASCII 0Ah

Output examples of sensitivity adjustment with an external weight

- The GLP output when the sensitivity of the balance is adjusted using an external weight is shown below.
- Clock to be used : Balance internal clock. Outputs data with the internal clock of the balance.

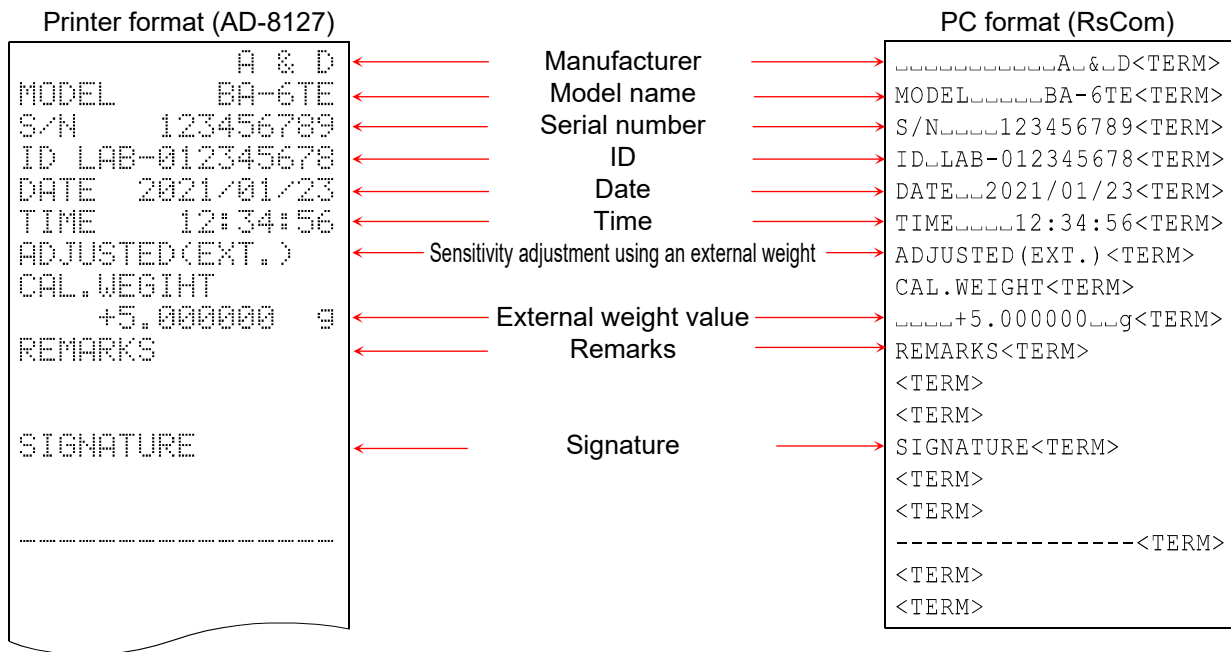

- ␣ : Space, ASCII 20h
- <TERM> : Terminator, CR LF or CR
- CR : Carriage return, ASCII 0Dh
- LF : Line feed, ASCII 0Ah

Output examples of calibration test with an external weight

- The GLP output when the weighing accuracy of the balance is checked using your own external weight is shown below. (No sensitivity adjustment is performed.)
- Clock to be used : Balance internal clock. Outputs data with the internal clock of the balance.

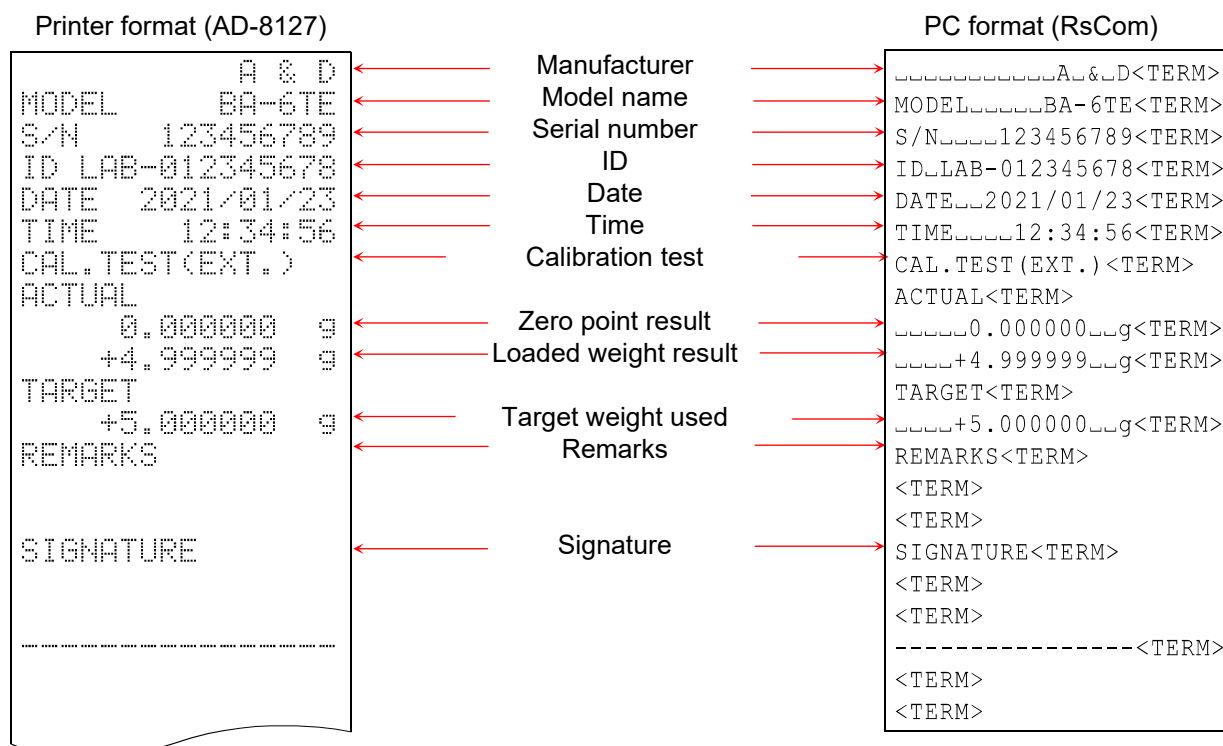

- ▯ : Space, ASCII 20h
- <TERM> : Terminator, CR LF or CR
- CR : Carriage return, ASCII 0Dh
- LF : Line feed, ASCII 0Ah

Title block and End block

Application/Operation

A "Title block" and "End block" can be added before and after a series of weighing values for data management.

Pressing the **GLP** button outputs the "Title block" and "End block" alternately.

Output method using the keys

- Step 1. In the weighing display, press the **GLP** button to output the title block.
- Step 2. Output the weighing value. The output method depends on the setting of the data output mode.
- Step 3. Press the **GLP** button to output the end block.

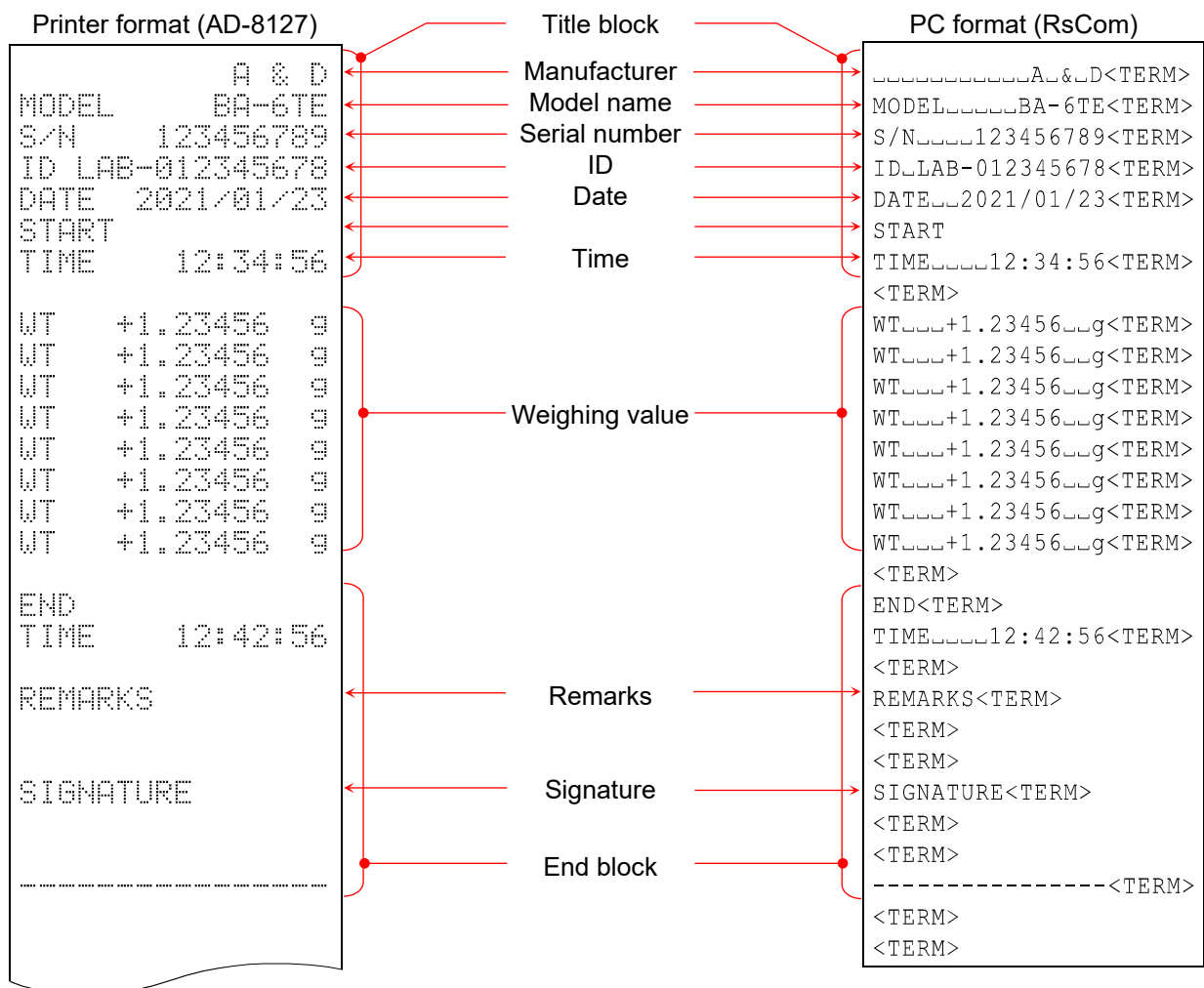

- ␣ : Space, ASCII 20h
- <TERM> : Terminator, CR LF or CR
- CR : Carriage return, ASCII 0Dh
- LF : Line feed, ASCII 0Ah

13.13. RS-232C interface

Display settings: MENU key  → System settings button  → Communication button  → RS-232C interface button  → [RS-232C interface] screen

1 Baud rate

2 Data bit, Parity bits

3 RS-232C data format

4 Back button

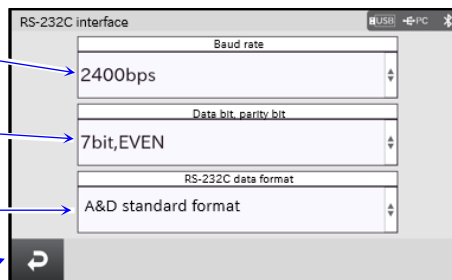

	Name	Setting value (setting range)	Description
1	Baud rate	600 bps, 1200 bps, 2400 bps, 4800 bps, 9600 bps, 19200 bps, 38400 bps	Selects the baud rate for the serial communication.
2	Data bit, Parity bits	7 bit, EVEN 7 bit, ODD 8 bit, NONE	Selects the bit length and parity bit for the serial communication.
3	Data format	A&D standard format, DP format, KF format, MT format, NU format, NU2 format, CSV format, UFC format	You can select the data format.
4	Back button	-	Returns to the previous screen.

 Settings in the red box are default values (factory settings).

- For specifications of RS-232C, refer to “[15.1. RS-232C specifications](#)”.
- For details on the data format, refer to “[19.2. Weighing data format](#)”.

13.14. USB interface

Display settings: **MENU** key  → **System settings** button  → **Communication** button  → **USB interface** button  → [USB interface] screen

1 USB device mode

2 USB data format

3 **Format the USB flash drive** button

4 **Back** button

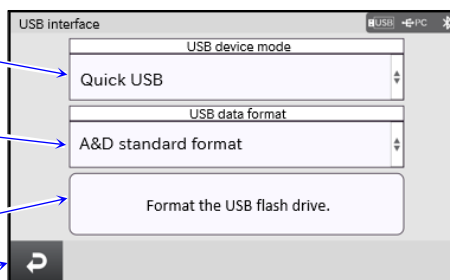





	Name	Setting value (setting range)	Description
1	USB device mode	Quick USB , USB Virtual COM	Selects the connection method when the USB cable is used.
2	Data format	A&D standard format , DP format, KF format, MT format, NU format, NU2 format, CSV format UFC format	You can select the data format.
3	Format the USB flash drive button	-	Format the USB flash drive.
4	Back button	-	Returns to the previous screen.

 Settings in the red box are default values (factory settings).

- To connect the balance with your personal computer, you can select from the Quick USB mode and USB Virtual COM mode. For details, refer to “[18. Connecting to a Personal Computer](#)”.
- For specifications of the USB interface, refer to “[15.2. USB specifications](#)”.
- For details on the data format, refer to “[19.2. Weighing data format](#)”.

13.15. Wired LAN

Display settings: **MENU** key  → **System settings** button  → **Communication** button  → **Wired LAN** button  → [Wired LAN] screen

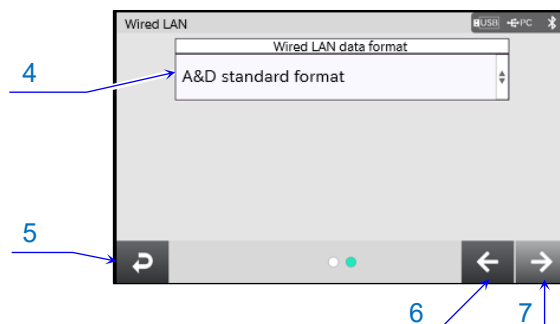
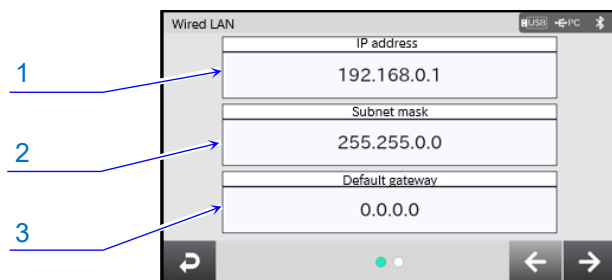

	Name	Setting value (setting range)	Description
1	IP address	For setting values, contact your LAN administrator.	Displays the IP address of the balance.
2	Subnet mask		Displays the subnet mask of the balance.
3	Default gateway		Displays the default gateway of the balance.
4	Data format	A&D standard format, DP format, KF format, MT format, NU format, NU2 format, CSV format, UFC format	You can select the data format.
5	Back button	-	Returns to the previous screen.
6	Previous button	-	Returns to the previous screen.
7	Next button	-	Transitions to the next screen.





A&D standard format Settings in a red box are default values (factory settings).

- For specifications of the wired LAN, refer to “[15.5. Wired LAN specifications](#)”.
- For details on the data format, refer to “[19.2. Weighing data format](#)”.

Cautions on the wired LAN

- For information about the connection to your local area network (LAN), contact your system administrator.

13.16. Bluetooth

Display settings: **MENU** key  → **System settings** button  → **Communication** button  → **Bluetooth** button  → [Bluetooth] screen

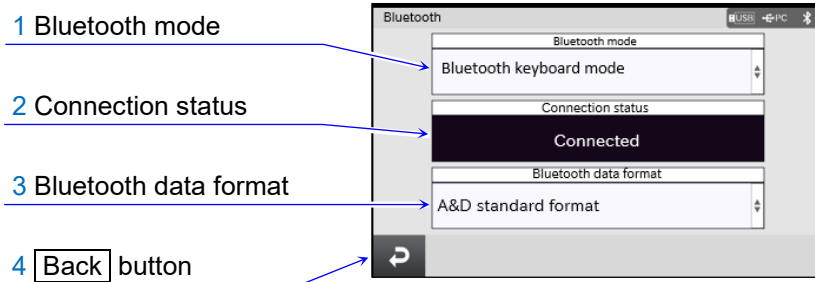





	Name	Setting value (setting range)	Description
1	Bluetooth mode	Bluetooth keyboard mode , Bluetooth serial mode	You can change the communication mode.
2	Connection status	-	The connection status is displayed.
3	Data format	A&D standard format , DP format, KF format, MT format, NU format, NU2 format, CSV format, UFC format	You can select the data format. (This applies when the Bluetooth mode is set to [Bluetooth serial mode].)
4	Back button	-	Returns to the previous screen.

 Settings in the red box are default values (factory settings).

Caution on Bluetooth

- In the Bluetooth keyboard mode, use a Bluetooth enabled device (such as a personal computer or smartphone) to perform a pairing. In the Bluetooth keyboard mode, the communication is one way from the balance to the Bluetooth enabled device. Only numerical values that represent weighing values are output.
- In the Bluetooth serial mode, you can use the personal computer connection dongle AD8541-PC to enable two-way communication where commands are sent from your personal computer. This connection allows WinCT, etc. to communicate.
- For details on the data format, refer to “[19.2. Weighing data format](#)”.
- Bluetooth® communication capability is disabled for regions where the balance is not certified as being compliant with local laws regarding use of Bluetooth® communication.

13.17. UFC format

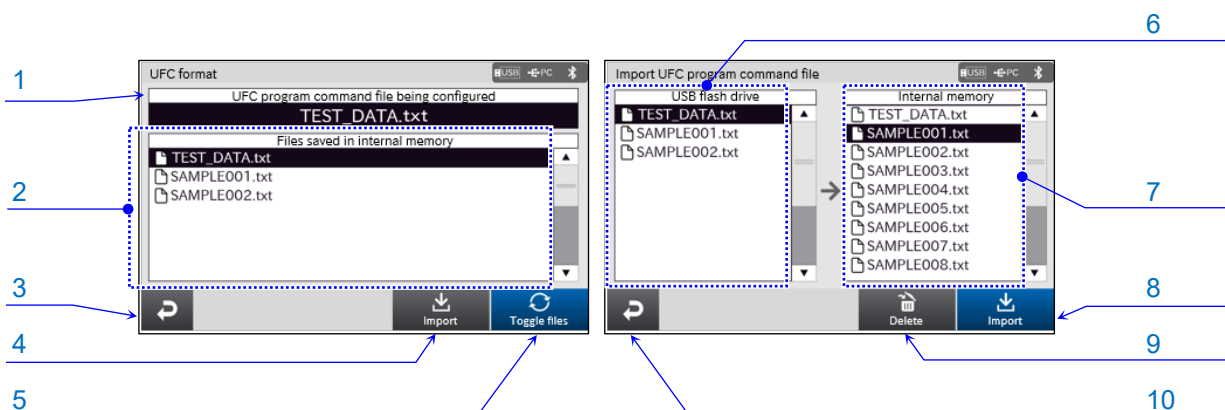

Display settings: **MENU** key  → **System settings** button  → **Communication** button  → **UFC format** button  → [UFC format] screen



	Name	Description
1	UFC program command file being configured	Displays the UFC program command file being configured.
2	Files saved in internal memory	You can view or select the UFC program command files stored in the balance's memory.
3	Back button	Displays the [Communication] screen.
4	Import button	Displays the [Import UFC program command file] screen. Can be used only when a USB flash drive is connected.
5	Toggle files button	Switches the UFC program command file being set to the file currently selected from the file list in the internal memory. Can be used only when a file is selected.
6	USB flash drive file list	You can view or select the UFC program command files stored in the USB flash drive. Only “.txt” format files are displayed.
7	Internal memory file list	Displays the UFC program command files stored in the internal memory.
8	Import button	<ul style="list-style-type: none"> <input type="checkbox"/> Imports the UFC program command file selected in the USB flash drive file list to the internal memory. Can be used only when a file is selected. <input type="checkbox"/> Up to 50 files can be imported. <input type="checkbox"/> Files cannot be imported if the following applies. <ul style="list-style-type: none"> ■ The number of characters in the program command exceeds 1024 characters. ■ The three characters “PF,” are missing at the beginning of the program command. ■ Another existing imported file has the same filename. ■ The filename has characters other than ASCII code. ■ The filename has the following characters: () , . - / ! ¥ ■ The filename is longer than 85 characters.
9	Delete button	Deletes the file selected in the UFC program command file list in the internal memory. Can be used only when a file is selected. The file being configured cannot be deleted.
10	Back button	Displays the [UFC format] screen.

- The UFC (Universal Flex Coms) function allows you to output contents of your choice when outputting the weighing data. For details, refer to “21. UFC Function”.

13.18. Language

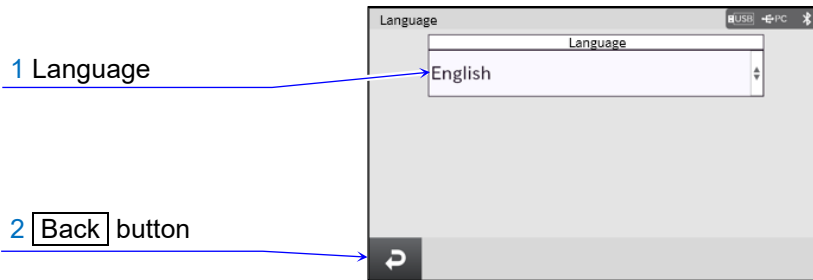

Display settings: **MENU** key  → **System settings** button  → **Language** button  →
[Language] screen



	Name	Setting value (setting range)	Description
1	Language	Japanese, English , Korean, Russian, Chinese, Spanish, German, French, Italian, Dutch, Portuguese	Selects the language used for the display.
2	Back button	-	Returns to the previous screen.

Settings in the red box are default values (factory settings).

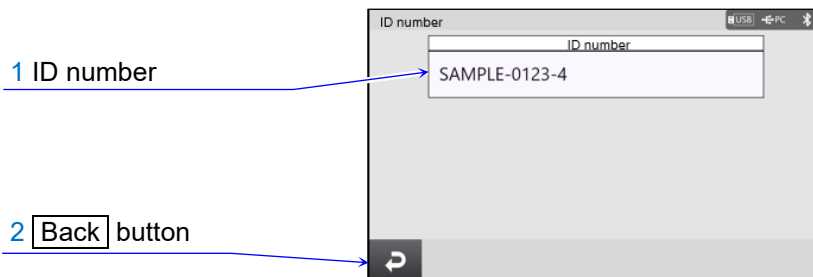

13.19. ID number settings

Display settings: **MENU** key  → **System settings** button  → **ID number** button →
[ID number] settings screen



	Name	Description
1	ID number	You can set an ID number of your choice.
2	Back button	Returns to the previous screen.

13.20. External input switch

Display settings: **MENU** key  → **System settings** button  → **External input switch** button  → [External input switch settings] screen

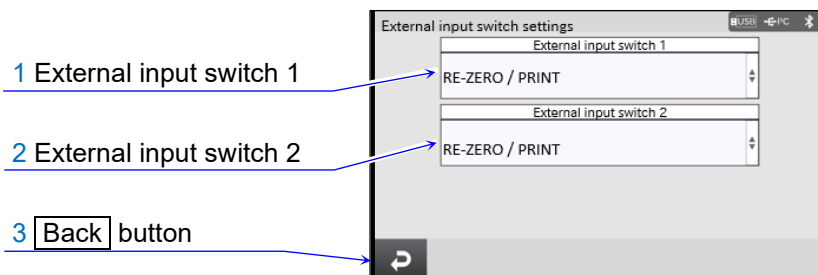



	Name	Setting value (setting range)	Description
1	External input switch 1	RE-ZERO / PRINT	You can change the settings for the function of connected external switches.
2	External input switch 2	Open/close the right breeze break door, Open/close the left breeze break door	
3	Back button	-	Returns to the previous screen.

RE-ZERO / PRINT Settings in the red box are default values (factory settings).

- You can change the function of connected external switches such as a foot switch in the device settings screen.
These settings allow you to perform operations from external switches.
- For the usage and specifications of external input terminals, refer to “[15.4. External input terminal \(external input switch\)](#)”.

13.21. Initialization



Display settings: **MENU** key  → **System settings** button  → **Initialization** button  → Perform initialization

- This function resets the various settings for the balance to the factory settings. Items to be initialized are as follows.
 - Sensitivity adjustment data
 - Weight values for the sensitivity adjustment and calibration test on your external weight
 - Setting values in the function table
 - Standard values for check functions
 - Unit weight in the Counting mode
 - 100% reference mass in the Percent weighing mode
 - UFC program command file
- Items that remain unchanged even if you perform initialization are as follows.
 - Registered users, user authorization
 - Date/time
 - History (login/logout, operation history, sensitivity adjustment history)
 - Balance information and software version

Caution

- Be sure to perform sensitivity adjustment after initializing the balance.

13.22. Balance status

Display settings: [MENU] key  → [Information] button  → [Balance status] screen

1 [Balance information] button

2 [Software version] button

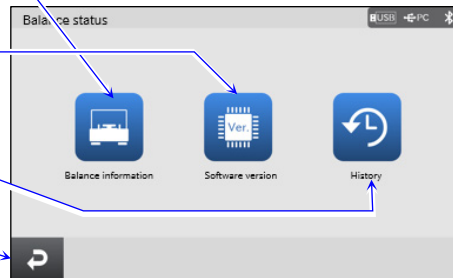

3 [History] button

4 [Back] button



	Name	Description
1	[Balance information] button	Displays the [Balance information] screen.
2	[Software version] button	Displays the [Software version] screen.
3	[History] button	Displays the [History] screen.
4	[Back] button	Returns to the previous screen.

13.23. Balance information

Display settings: [MENU] key  → [Information] button  → [Balance information] button  → [Balance information] screen

1 Model name

2 Capacity

3 Readability

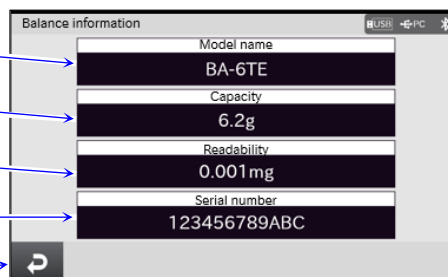

4 Serial number

5 [Back] button



	Name	Description
1	Model name	Displays the model name.
2	Capacity	Displays the capacity.
3	Readability	Displays the readability (scale interval).
4	Serial number	Displays the serial number.
5	[Back] button	Returns to the previous screen.

13.24. Software version

Display settings: **MENU** key  → **Information** button  → **Software version** button  → [Software version] screen

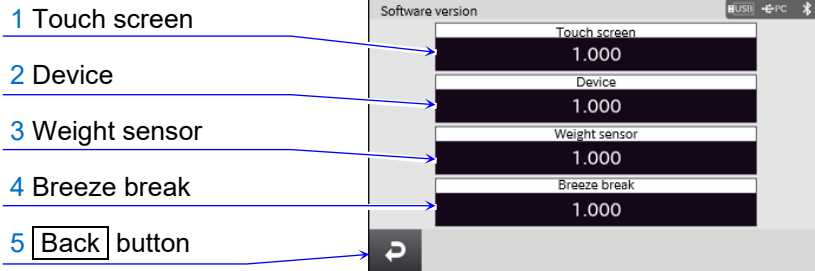

	Name	Description
1	Touch screen	Display the software version of each function used for the balance.
2	Device	
3	Weight sensor	
4	Breeze break	
5	Back button	Returns to the previous screen.



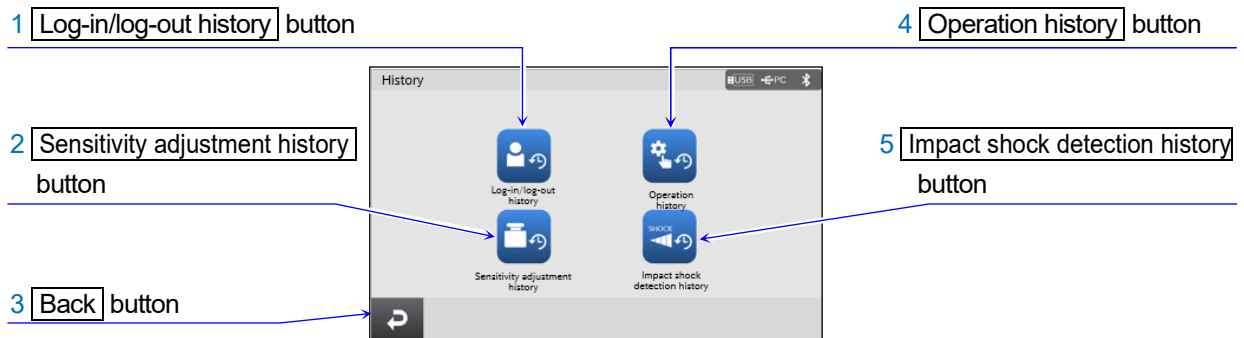

13.25. History

Display settings: **MENU** key  → **Information** button  → **History** button  → [History] screen



	Name	Description
1	Log-in/log-out history button	Displays the [Log-in/log-out history] screen.
2	Sensitivity adjustment history button	Displays the [Sensitivity adjustment history] screen.
3	Back button	Returns to the previous screen.
4	Operation history button	Displays the [Operation history] screen.
5	Impact shock detection history button	Displays the [Impact shock detection history] screen.

13.26. Log-in/log-out history



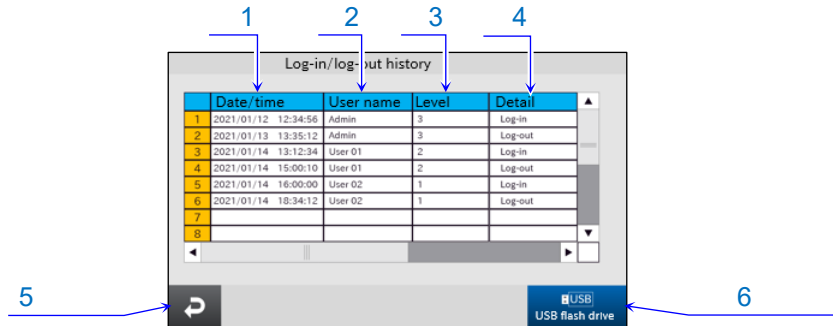

Display settings: MENU key  → Information button  → History button  → Log-in/log-out history button  → [Log-in/log-out history] screen



	Name	Description
1	Time	Displays the time when log-in/log-out operations were detected.
2	User name	Displays the user that performed the detected log-in/log-out operation.
3	Level	Displays the user level of the user that performed the log-in/log-out operation. 0: Operator 1: Supervisor 2: Lab manager 3: Administrator
4	Detail	Displays “Log-in” or “Log-out”.
5	Back button	Returns to the previous screen.
6	USB output	Outputs the history to the USB flash drive as a CSV file.

- The history function saves data only in English.
- Up to the latest 100 history records are displayed.
- Up to the latest 1000 history records are stored and can be output to the USB flash drive as a CSV file.
- If the history exceeds 1000 records, the oldest record is deleted and the latest record is added.

13.27. Operation history

Display settings: [MENU] key  → [Information] button  → [History] button  → [Operation history] button  → [Operation history] screen

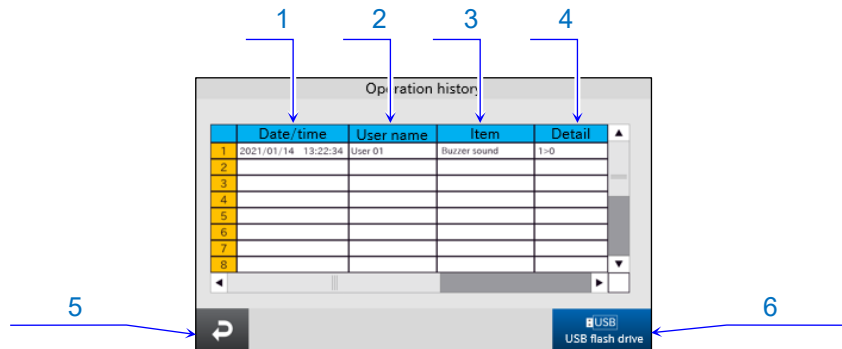



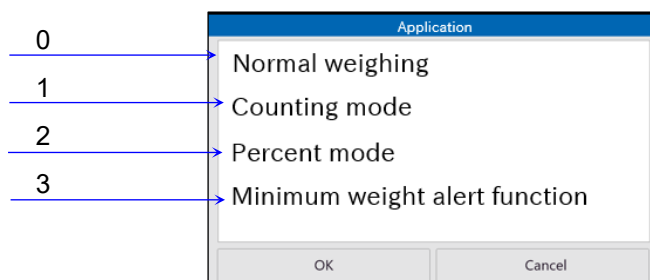

	Name	Description
1	Time	Displays the time when settings were changed.
2	User name	Displays the logged in user when the operation was detected.
3	Item	Displays the item for which settings were changed.
4	Detail	Displays the details of how settings were changed.
5	[Back] button	Returns to the previous screen.
6	USB output	Outputs the history to the USB flash drive as a CSV file.

- The history function saves data only in English.
 - Up to the latest 100 history records are displayed.
 - Up to the latest 1000 history records are stored and can be output to the USB flash drive as a CSV file.
 - If the history exceeds 1000 records, the oldest record is deleted and the latest record is added.
- * Values in the Detail for the operation history represent the selection in the displayed order. For example, in [Application] below, 0 represents the first selection from the top, 1 the second selection, 2 the third selection and 3 the fourth selection.



13.28. Sensitivity adjustment history



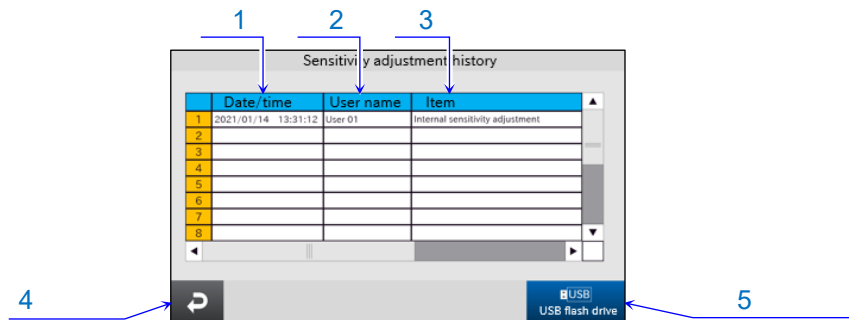

Display settings: **MENU** key  → **Information** button  → **History** button  → **Sensitivity adjustment history** button  → [Sensitivity adjustment history] screen



	Name	Description
1	Time	Displays the time when sensitivity adjustment was performed.
2	User name	Displays the logged in user when the operation was detected.
3	Item	Displays the results detected by sensitivity adjustment.
4	Back button	Returns to the previous screen.
5	USB output	Outputs the history to the USB flash drive as a CSV file.

- The history function saves data only in English.
- Up to the latest 100 history records are displayed.
- Up to the latest 1000 history records are stored and can be output to the USB flash drive as a CSV file.
- If the history exceeds 1000 records, the oldest record is deleted and the latest record is added.

13.29. Impact shock detection history

Display settings: **MENU** key  → **Information** button  → **History** button  → **Impact shock detection history** button  → [Impact shock detection history] screen

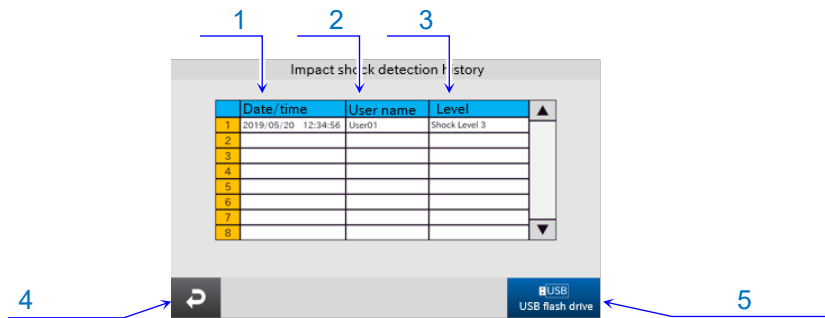

	Name	Description
1	Date/time	Displays the time when the impact was detected.
2	User name	Displays the user who was logged in at the time of impact detection.
3	Level	Displays the impact detection level.
4	Back button	Returns to the previous screen.
5	USB output	Outputs the history to a USB flash drive as a CSV file.

- The history function saves only in English.
- If the impact level is level 3 or higher, it is automatically stored in the balance with the date and time.
- Impact data when the balance is not energized (during transportation, etc.) is not stored.
- The history shows the latest data up to 100 items.
- The latest data, up to 1000 items, is saved in the history and can be output as a CSV file to a USB flash drive.
- If the history exceeds 1000 items, the oldest data will be deleted and replaced with the latest data.

14. Underhook

The built-in underhook is used for underhook weighing such as measurement of magnetic materials and the like.

To use the underhook, open the cap on the bottom of the balance.

Caution

- Do not apply excessive force to the underhook part.
- Do not open the cap unless necessary. (For protection from dust)
- The underhook can be used only in the hanging direction (pulling direction).
- If the balance is tilted greatly, attached parts such as the weighing pan will come off. Remove them before work.
- Keep in mind that draft enters the balance easily when the underhook cap is removed, affecting the weighing values.

Usage

Step 1. Remove the bottom cover of the balance.

The underhook can be seen.

Step 2. Hang the weighing pan from the underhook by using a line.

Step 3. Place the balance on a sturdy table with a hole.

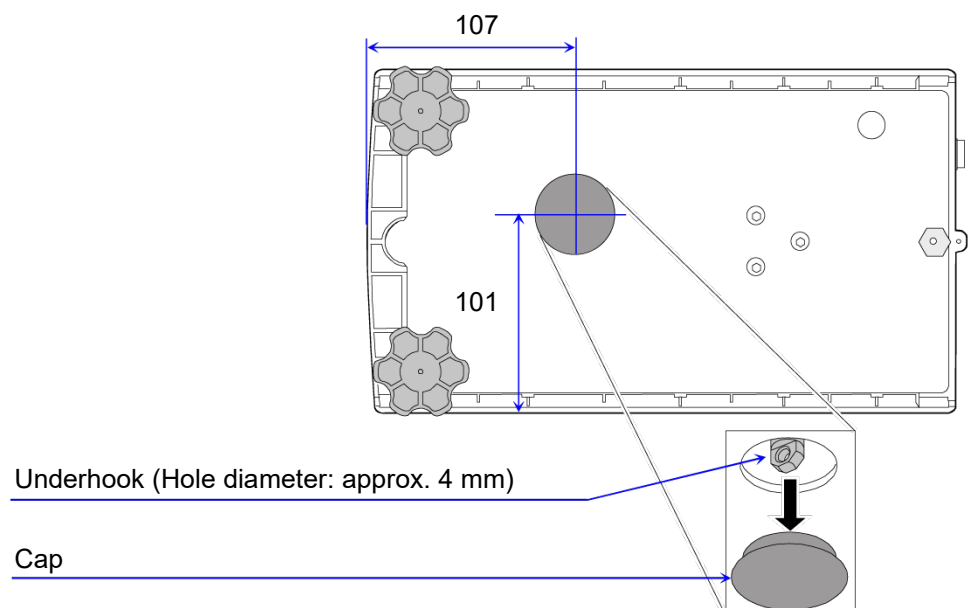
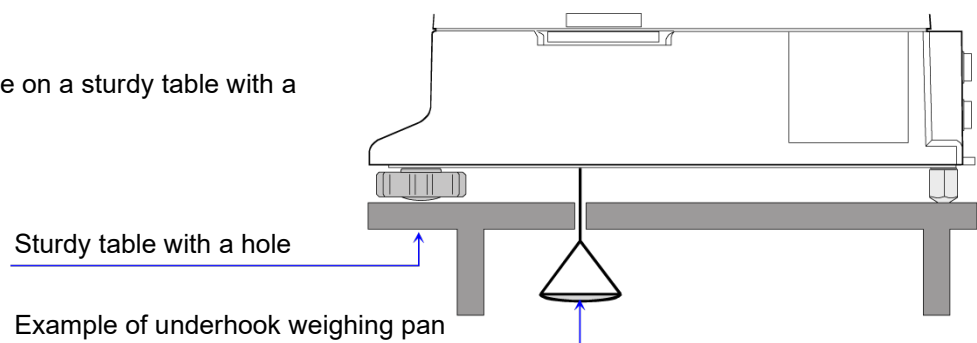

15. Interface Specifications (Standard)

15.1. RS-232C specifications

Connector	D-Sub 9-pin (male)	
Transmission system	EIA RS-232C	
Transmission form	Asynchronous, bi-directional, all half duplex	
Transmission rate	5 times/second, 10 times/second	
Signal format	Baud rate	600, 1200, 2400, 4800, 9600, 19200, 38400 bps
	Data bits	7 bits or 8 bits
	Parity	EVEN or ODDAt a data bit length of 7 bits NONE.....At a data bit length of 8 bits
	Stop bits	1 bit
	Code	ASCII

1 character format

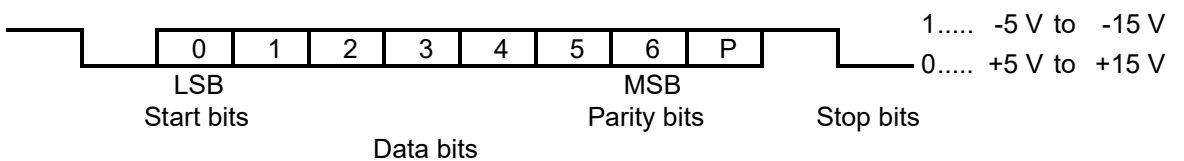

D-Sub 9-pin assignments

Pin No.	Signal name	Direction	Description
1	-	-	Same potential as SG *1
2	TXD	Output	Transmit data
3	RXD	Input	Transmit data
4	-	-	N.C.
5	SG	-	Signal ground
6	DSR	Output	Data set ready
7	RTS	Input	Request to send
8	CTS	Output	Clear to send
9	-	Output	12V output *1

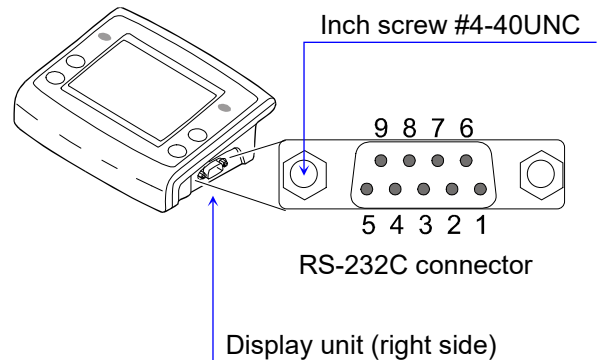

Signal names other than TXD and RXD are names on the DTE side.

Wiring diagram
(when connected to a personal computer)

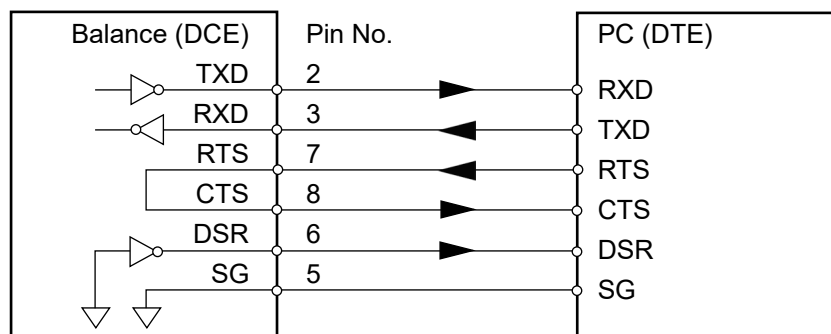

*1 Used with some A&D peripherals. When connecting to other companies' products such as personal computers and PLCs, do not connect the wires. Make sure a compatible cable is used, as using the wrong connection cable may damage the device.

□ For settings for RS-232C, refer to "13.13. RS-232C interface".

Display settings: **MENU** key → **System settings** button → **Communication** button → **RS-232C interface** button → In the [RS-232C interface] screen, select [Baud rate], [Data bit, parity bit], [Data format].

15.2. USB specifications

Connector	Mini-B USB (female), (dedicated for USB flash drives) USB Type A		
Standards	USB 2.0		
Device class	HID (Human Interface Device)	:	Quick USB
	CDC (Communication Device Class)	:	Virtual COM



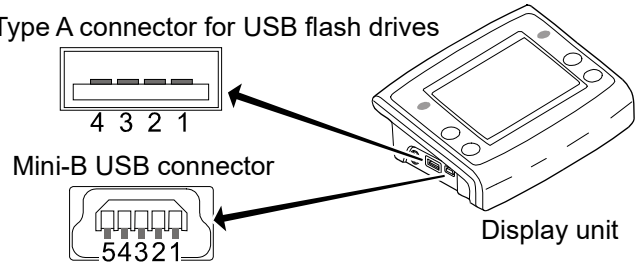

Mini-B USB pin assignment

Pin No.	Signal name	Direction	Description
1	VBUS	Input	Power+
2	D-	-	Data transmission-
3	D+	-	Data transmission+
4	ID	-	N.C.
5	GND	-	Power-

USB Type A connector for USB flash drives



- For settings for the USB interface, refer to “13.14. USB interface”.

Display settings: **MENU** key  → **System settings** button  → **Communication** button  → **USB interface** button  → In the [USB interface] screen, select [USB device mode], [Data format].

15.3. USB flash drive (USB host)



- In the BA-T series, you can connect a USB flash drive to the USB type A connector. You can save weighing data, etc. in the USB flash drive and import the data into Windows or macOS computers easily. (No driver is required)
- The balance weighing data, etc. are saved on the USB flash drive in the CSV format. You can save the results of check functions as a PDF file. Change the USB data format as required.
- A file called BA-T*****.CSV is generated under the root directory of the USB flash drive and the weighing data is saved there, when the weighing data is output with a print button, etc. Copy this file to your computer for managing data, etc.
- As long as the home screen (weighing screen) is shown, the new data is appended to the next line of the old data. (A new file is not generated.)
- Once other screen is shown, a new file is generated and the data is added.

Caution

- Do not connect anything other than a USB flash drive to the USB A type connector.
- When you want to remove the USB flash drive from the balance, be sure to press the button for removing the USB flash drive before doing so. Otherwise, data may not be written.
- To prevent unexpected data loss, use the USB flash drive dedicated for this balance and do not use it with other devices.
- If other data is saved, data may be damaged. No compensation should be paid for loss of data. Be sure to format the USB flash drive on your computer before using the balance.
- You cannot use USB flash drives with security functions such as antivirus software.
- You cannot use USB flash drives formatted as NTFS or exFAT. Use USB flash drives formatted as FAT (FAT 16) or FAT 32.
- Some USB flash drives may not work correctly even if they satisfy the above conditions. Not all USB flash drives are guaranteed to work.
- You cannot use USB hubs.
- If the balance does not work after you connecting or removing a USB flash drive that does not satisfy the specified conditions, disconnect the AC adapter of the balance and turn on the power again.

15.4. External input terminal (external input switch)

- The external input terminal provides the functions "RE-ZERO" key input on the balance, "PRINT" key input" and "opening and closing the breeze break doors" to the "contact input" via the wire extended from the connected plug.
- To turn the "contact input" on, short it for 100 ms or more.
- To use the external input terminal, you must select the function in the [External input switch] screen. Refer to "13.20. External input switch". □ Settings in a red box are default values (factory settings).

Display settings: MENU key  → System settings button  → External input switch button  → [External input switch] screen

Name	Setting value (setting range)
External input switch 1	RE-ZERO / PRINT,
External input switch 2	Open/close the right breeze break door, Open/close the left breeze break door

- The display unit has two external input terminals: EX.SW1 and EX.SW2.
- A foot switch (AX-SW137-PRINT) that functions as a PRINT key (sold separately) is available. A foot switch (AX-SW137-REZERO) that functions as a RE-ZERO key (sold separately) is available.
- For the plug connected to the external input terminal, a $\phi 3.5$ mm stereo plug MP-013LC (Marushin Electric Mfg. Co., Ltd) or an equivalent product can be used.

Caution

- Plugs are not included. If you prepare the plug yourself, you need to solder the plug, wire, switch, etc. yourself.

Circuit diagram of external input terminals in the display unit

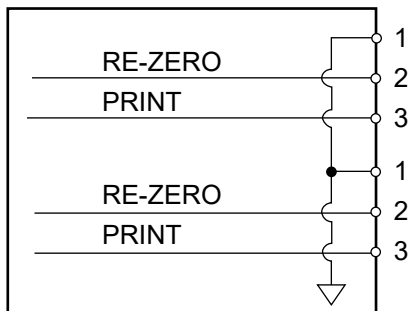

External input terminals of the display unit

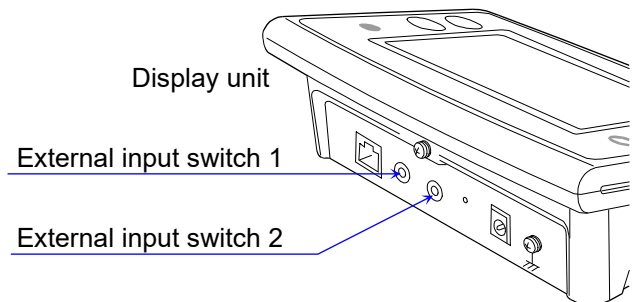

Example of compatible plug

Pin assignment

Pin	Description
1	GND common ground terminal
2	RE-ZERO external contact input
3	PRINT external contact input

Circuit diagram

External view

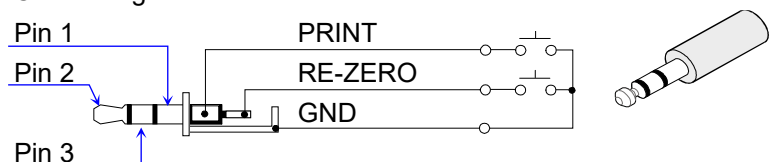



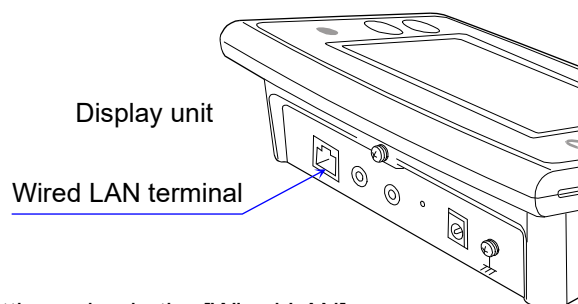

15.5. Wired LAN specifications

Connector RJ45
Protocol TCP/IP



- To use the wired LAN terminal, you must select the setting value in the [Wired LAN] screen. Refer to “[13.15. Wired LAN](#)”. Settings in a red box are default values (factory settings).

Display settings: MENU key  → System settings button  → Communication button  → Wired LAN button  → [Wired LAN] screen

Name	Setting value (setting range)
IP address	For setting values, contact your LAN administrator.
Subnet mask	
Default gateway	
Data format	<input type="checkbox"/> A&D standard format, DP format, KF format, MT format, NU format, NU2 format, CSV format

- For details on the data format, refer to “[19.2. Weighing data format](#)”.

Cautions on the wired LAN

- For information about the connection to your local area network (LAN), contact your system administrator.
- To connect to a PC directly, use a cross cable.
To connect via a hub, use a straight cable.
- Data can be collected by using Windows data communication software "WinCT-Plus".
For details on "WinCT-Plus", refer to "[18.4.2 WinCT-Plus \(wired LAN\)](#)".

15.5.1. Network settings

To make the LAN connection, the settings of the IP address and subnet mask for a computer and the BA-T series need to be set. For the IP address allocation, ask your network administrator. The factory settings for the BA-T series are as follows. The port number is fixed.

IP address	Subnet mask	Default gateway	Port number
192.168.0. 1	255.255. 255. 0	0.0.0.0	10001

Caution

Make sure to confirm with your network administrator before connecting to the existing network, as the BA-T series might cause a network trouble. Please note that A&D shall not be liable for any problems that occurs with your network.

Setting of the IP address for computer

Set the IP address and subnet mask of your computer as follows.

Open the TCP/IP properties screen to select 'Use the following UP address.'

Enter the IP address and subnet mask.

For the setting values, ask your network administrator.

Example) When directly connecting a computer to a BA-T series balance.

Use a crossing cable for LAN.

	IP address	Subnet mask
Computer	192.168.0. 12	255.255. 255. 0
BA-6TE	192.168.0. 1	255.255. 255. 0

* The sequence to open the TCP/IP properties screen

For Windows10:

'Control Panel' → 'Network and Internet' → 'Network and Sharing Center' → 'Ethernet' → 'Ethernet Properties' → Internet Protocol Version 4 (TCP/IPv4) Properties'

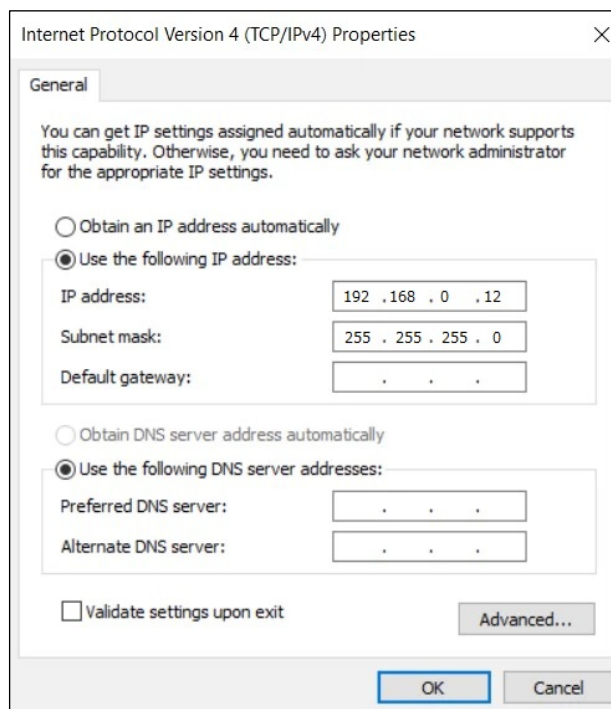

16. Connection with Peripheral Devices

BA-T series analytical balances are equipped with an RS-232C connector and a mini-B USB connector that allow connection to peripherals, personal computers, PLCs, etc.

16.1. Cables required to connect to peripheral devices

The connection cables that match the interface used with the peripheral device are as follows.

Peripheral and connection cable compatibility table

Peripherals		Communication interface to use	Connection cable		Note
Product name	Model		Standard or sold separately	Cable model	
Multi-functional compact printer	AD-8127	RS-232C	Standard accessory: RS-232C cable included with the printer	AX-KO2741-100	*1
PLC			Sold separately		*2 *3
PC		USB	Standard accessory: USB cable included with the balance	AX-KO5465-180	
		Wired LAN	Sold separately: LAN cable		*4





Note

- *1 When using the AD-8529PR-W (Bluetooth converter, sold separately), the RS-232C cable that comes with the printer is not used.
- *2 Check the interface specifications of the BA-T series and PLC, and prepare a compatible cable.
- *3 Can be connected to a personal computer using AX-USB-9P/AD-8529PC-W/AD-1688/AD-8527. When transferring data, the connection cable that comes with those products can be used.
- *4 To connect to a personal computer directly, use a cross cable. To connect via a hub, use a straight cable.

16.2. Data output method

The operation of the balance can be changed by setting the function table to the settings suitable for the intended use.

For details on the function table, refer to “13.7. Data output”.

Display settings: **MENU** key  → **System settings** button  → **Communication** button  → **Data output** button  → [Data output] screen

- The output method of weighing data via the RS-232C/USB interface can be specified in the [Data output mode] screen of the function table.





Display settings: **MENU** key  → **System settings** button  → **Communication** button  → **Data output** button  → **Data output mode** button  → [Data output mode] screen

Table of the data output mode

Item	Setting value	Description
Data output mode	Key mode	<ol style="list-style-type: none"> 1. Outputs with the PRINT button if the weighing value is stable. 2. Immediately outputs with the PRINT button regardless of whether or not the weighing value is stable. 3. Immediately outputs with the PRINT button if the weighing value is stable. If the weighing value is not stable, outputs once it has stabilized.
	Auto print mode	<ol style="list-style-type: none"> 1. Automatically outputs if the weighing value is stable. (referencing zero) 2. Automatically outputs if the weighing value is stable (referencing the previous stability)
	Stream mode	Outputs continually
	Interval mode	Starts outputting with the PRINT button at the specified period.

□ Settings in a red box are default values (factory settings).

16.3. Examples: Connecting multiple peripheral devices

16.3.1. Printer and personal computer connection

Table of settings by connection method

Connection method		Function table for the connection interface/connected device	
Interface	Device	Class	Description
(Common settings)			Selects the data output mode suitable for the intended use and settings of the printer/personal computer *1
RS-232C	Printer	Serial interface	Selects the data output format suitable for the settings of the printer and applications. (A&D standard format, DP format)
USB	PC	USB interface	Selects an output format that allows the personal computer to process easily
Wired LAN		Wired LAN	

*1 The data output mode is an item common to the printer and personal computer. The weighing value is output at the same timing.

Connecting the printer to the balance

- The AD-8127 multi-functional compact printer is a printer for balances.
- Connect the printer and the balance display unit with an RS-232C cable.

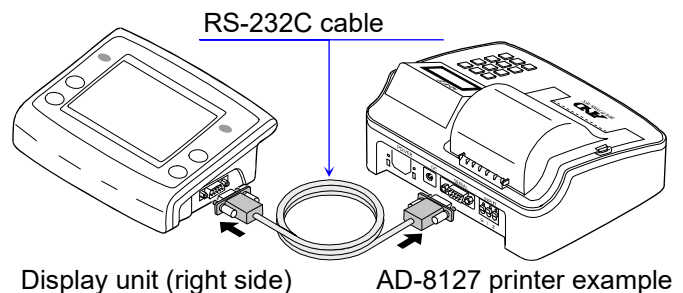

Connecting the personal computer to the balance

- To connect the balance and the personal computer only, you can connect with the USB cable, LAN cable or RS-232C cable.
- If the personal computer does not have an RS-232C interface (COM port), you can use a USB converter (AX-USB-9P).

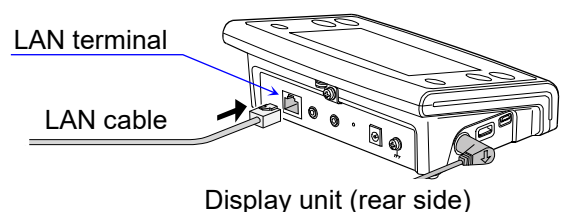
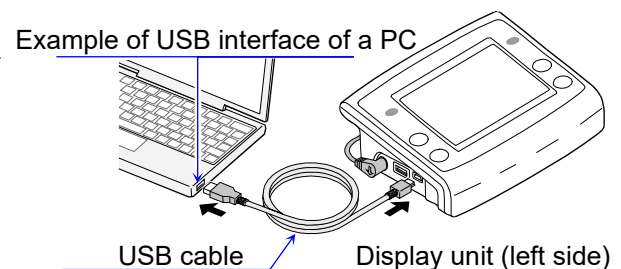
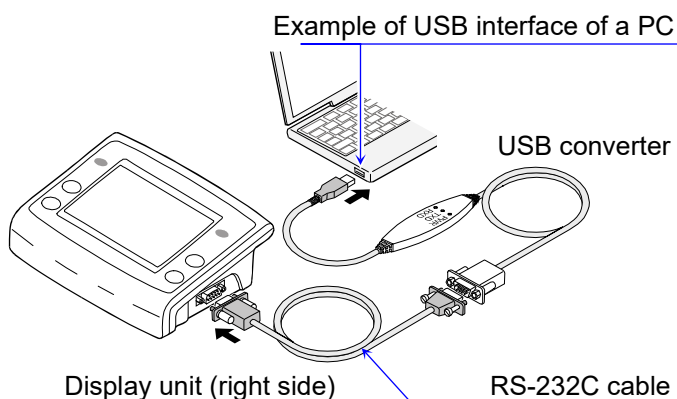
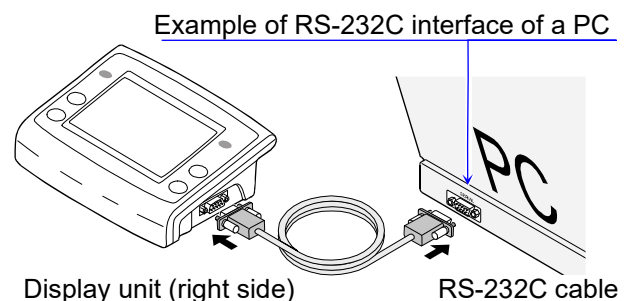

17. Printing Weighing Value Data with a Printer

Refer to the following setting examples for the printer settings and the balance's function table according to the printer to be used and the method of printing weighing data.

17.1. For an AD-8127 multi-functional compact printer

17.1.1. Printing only weighing value data

Common settings for the balance when printing only weighing value data with the AD-8127

Item	Description
Data format	A&D standard format

Settings when printing only weighing value data with the AD-8127





Printing method	Balance function table	AD-8127 function table	
	Description	PRN .MODE	Description
Prints weighing value data when the PRINT button of the balance is pressed	Key mode: Output only when the display is stable	EXT.KEY	External key print mode
	Key mode: Output regardless of whether the display is stable or unstable *1		
	Key mode: Output when stable		
Automatically prints weighing value data according to the change in the weighing value	Auto print mode: Reference = zero point	EXT.KEY	External key print mode
	Auto print mode: Reference = Last stable value		
Prints weighing value data at regular intervals	Interval output mode *1	MANUAL	Manual print mode
Prints weighing value data when the PRINT button of the printer is pressed	Stream mode *1		
Prints weighing value data in chart format.		CHART	Chart print mode

*1 Unstable data is also output.





To set the AD-8127 to a mode other than dump print mode and also print unstable data, change the setting to "Print unstable data ("US PRN", "PRINT")" in the function table of the AD-8127.

- For details on the A&D standard format, refer to "19.2. Weighing data format".

You can select the A&D standard format for each connection in the following screen.

MENU key  → **System settings** button  → **Communication** button  → **RS-232C interface** button  → In the [RS-232C interface] screen, select [A&D standard format].

- For details about [Key mode], [Auto print mode], [Interval output mode] and [Stream mode], refer to "19.1. Data output mode". Set the data output mode in the following screen.

MENU key  → **System settings** button  → **Communication** button  → **Data output** button  → **Data output mode** button  → In the [Data output mode] screen, select the mode.

17.1.2. Printing weighing value data with the ID number and timestamp using the clock/calendar function of the balance

Common settings of the balance to print weighing value data and other information with the AD-8127

Item	Description
Data format	DP format

Settings of the balance to print weighing value data and other information with the AD-8127

Printing method	Balance function table	AD-8127 function table	
	Description	PRN .MODE	Description
Prints weighing value data when the PRINT button of the balance is pressed	Key mode: Output only when the display is stable	DUMP	Dump print mode
	Key mode: Output regardless of whether the display is stable or unstable *1		
	Key mode: Output when stable		
Automatically prints weighing value data according to the change in the weighing value	Auto print mode: Reference = zero point		
	Auto print mode: Reference = Last stable value		
Prints weighing value data at regular intervals	Interval output mode *1		





*1 Unstable data is also output.

To set the AD-8127 to a mode other than dump print mode and also print unstable data, change the setting to "Print unstable data ("US PRN", "PRINT")" in the function table of the AD-8127.

- You cannot print with printer keys or in chart format.
- For details on the DP format, refer to "19.2. Weighing data format".
You can select the DP format for each connection in the following screen.

MENU key  → **System settings** button  → **Communication** button  → **RS-232C interface** button  → In the [RS-232C interface] screen, select [DP format].

- For details about [Key mode], [Auto print mode], [Interval output mode] and [Stream mode], refer to "19.1. Data output mode". Set the data output mode in the following screen.

MENU key  → **System settings** button  → **Communication** button  → **Data output** button  → **Data output mode** button  → In the [Data output mode] screen, select the mode.

17.1.3. Printing information other than weighing value data

To print sensitivity adjustment/calibration test reports (GLP compliant output) or to perform output of the statistical calculation result calculated by the balance, change the setting of the printer to the dump print mode.





Settings to print information other than weighing value data with the AD-8127

PRN .MODE	Description
DUMP	Dump print mode

- Switching the AD-8127 print mode (PRN MODE)

By pressing and holding the **ENTSAVE** key of the AD-8127, it is possible to switch between EXT.KEY (External key print mode) and DUMP (Dump print mode) without using the function table of the printer. This is convenient when temporarily switching the AD-8127 to dump print mode for GLP output, etc.

- The data output compliant with "GLP/GMP" can be output to a personal computer or optional printer. Set the GLP/GMP settings in the following screen.

MENU key  → **System settings** button  → **Communication** button  →
GLP output button  → Set in the [GLP output] screen.

18. Connecting to a Personal Computer





18.1. Quick USB mode

- The quick USB mode is a function where a balance connected to a personal computer with a USB cable and inputs the output of the balance directly to the software on the personal computer, such as Excel or Word. The supported OS is Windows 7 or later.
Since the Windows standard driver (HID) is used, there is no need to install a dedicated driver and communication is possible simply by connecting.

Caution

- Quick USB is a one-way communication from the balance to the personal computer. It is not possible to send commands to control the balance from the personal computer.
- Turn off the screen saver and standby mode of the personal computer.
- Do not use Quick USB when the data output mode of the balance is set to the stream mode.
- In stream mode, the balance keeps outputting weighing data to the personal computer. It may cause unintended operation on the computer.

Setting procedure

- To use the Quick USB mode, set the function table of the balance to [Quick USB mode].
[MENU] key  → [System settings] button  → [Communication] button  →
[USB interface] button  → Select in the [USB interface] screen.

USB output format

- When USB is used, select the output format in the [13.14. USB interface] screen.
- For details on the output format, refer to "19.2. Weighing data format" (function table).

Setting procedure (to send weighing data with the [PRINT] button of the balance)

- Step 1. In the function table of the balance, set to [Quick USB].
- Step 2. Connect the balance to the personal computer with the included USB cable.
- Step 3. When the personal computer is connected to the balance for the first time, the computer will automatically start installing the driver.
- Step 4. Start the software (Excel, etc.) used for weighing data transmission on the computer.
- Step 5. Be sure to set the keyboard to single-byte input mode. (Data cannot be entered correctly in the double-byte input mode.)
- Step 6. Place the cursor where you want to enter the weighing data.
- Step 7. Press the [PRINT] button  of the balance to send weighing data from the balance and enter it at the cursor position.
- Step 8. To finish data transmission, disconnect the USB cable.

18.2. Virtual COM mode

- Virtual COM mode is a function where a balance connected to a personal computer with the included USB cable, creates a COM port on the personal computer and performs bidirectional communication.
- The supported OS is Windows 7 or later. When using the mode for the first time on a personal computer running anything other than Windows 10, it is necessary to install the dedicated driver on the personal computer.
- For details on installation of the USB interface “Virtual COM mode” driver for the GX-A/GF-A series, refer to our website (<https://www.aandd.jp>).
- Communication equivalent to RS-232C is possible by selecting the COM port with WinCT (Windows Communication Tools Software).
In Virtual COM mode, it is not necessary to set the baud rate, data bit, parity, or stop bit of the data communication software.

Caution

- When installing the driver for Virtual COM mode for the first time, it may take some time to install.

Setting procedure

- To use the Virtual COM mode, set [Virtual Com mode] in the function table of the balance.
[MENU] key  → [System settings] button  → [Communication] button  →
[USB interface] button  → Select in the [USB interface] screen.

18.3. RS-232C

- The RS-232C interface of the balance is DCE (Data Communication Equipment) that can be connected to a personal computer.
The RS-232C cable to be connected is a straight type.
If the computer does not have an RS-232C connector, connect it in USB Virtual COM mode.

18.4. LAN

- Refer to “15.5. Wired LAN specifications”.

18.5. Bluetooth

- Refer to “13.16. Bluetooth”.

18.6. Data communication software

18.6.1. WinCT (USB Virtual COM mode or RS-232C)

- WinCT is data communication software for Windows that allows you to easily receive data on your computer the weighing data of the balance. Use the Virtual COM mode via USB interface or the RS-232C interface for the communication settings of the personal computer.
- WinCT can be downloaded from our website (<https://www.aandd.jp>).
For the installation and setup of WinCT, refer to "WinCT Setup Manual" and "WinCT Operation Manual" on our website.
- WinCT consists of three applications: "RsCom", "RsKey", and "RsWeight".

"RsCom"

- Controls the balance by sending commands to the balance.
- Displays the received data and saves it as a text file (.txt).
- Communicates with multiple balances by performing multiple operations.
- Runs at the same time as other applications. (Does not occupy the computer)
- Receives the GLP compliant output data of the balance.

"RsKey"

- Enters the weighing data of the balance directly into other applications.
- Any type of application, such as Word or Excel, can be used as long as keyboard input is possible.
- Inputs the GLP compliant output of the balance.
- The test display function allows you to use your computer as an external display for the balance.

"RsWeight"

- The received data can be graphed in real time.
- The maximum value, minimum value, average value, standard deviation, fluctuation count, etc. of the received data can be calculated and displayed.

18.6.2. WinCT-Plus (wired LAN)

- WinCT-Plus is data communication software for Windows that allows you to easily receive data on your computer the weighing data of the balance. Use the wired LAN interface, Virtual COM mode via USB interface, or the RS-232C interface for the communication settings of the personal computer.
- WinCT-Plus can be downloaded from our website (<https://www.aandd.jp>).
For the installation and setup of WinCT-Plus, refer to the information about "WinCT-Plus" on our website.
- WinCT-Plus offers the application "RsMulti".

"RsMulti"

- Sends data to a single personal computer from multiple weighing devices connected to the Ethernet (LAN) for management.
- You can connect up to 100 weighing devices. This may be restricted depending on the performance of the personal computer or data retrieval frequency.
- You can press the **PRINT** button on weighing devices to send data to the personal computer.

19. Data Output

19.1. Data output mode

- The timing of data output of the balance can be changed by using the [Data output mode] screen in the function table.
- You can configure the [Key mode], [Auto print mode], [Interval output mode] and [Stream mode] settings in the following screen.



19.1.1. Key mode

Output only when the display is stable

- If the **PRINT** button  is pressed when the stabilization indicator is displayed, the weighing value will be output once.
At this time, the weighing value display will blink once to show that it has been output.

Output regardless of whether the display is stable or unstable

- Regardless of whether the stabilization indicator is turned on or not, the weighing value will be output when the **PRINT** button  is pressed.

Output after the display becomes stable

- If the **PRINT** button  is pressed when the stabilization indicator is displayed, the weighing value will be output once.
If the stabilization indicator is not displayed, the weighing value will be output once the next time the stabilization indicator is turned on.
At this time, the weighing value display will blink once to show that it has been output.

19.1.2. Auto print mode

Zero point

- If the weighing value exceeds the range specified with [Bandwidth], [Standard] or [Polarity] in the [Data output mode] screen in the function table from the standard "zero display" and the stabilization indicator is displayed, the weighing value will be output once. In addition, if the **PRINT** button  is pressed when the stabilization indicator is displayed, the weighing value will be output once.
At this time, the weighing value display will blink once to show that it has been output.

Last stable value

- If the weighing value does not fall below the range specified with [Bandwidth], [Standard] or [Polarity] in the [Data output mode] screen in the function table from the standard "latest value with the stabilization indicator displayed" and the stabilization indicator is displayed, the weighing value will be output once. In addition, if the **PRINT** button  is pressed when the stabilization indicator is displayed, the weighing value will be output once. At this time, the weighing value display will blink once to show that it has been output.



19.1.3. Stream mode

- Regardless of whether the stabilization indicator is on or not, the weighing value will be output at the display refresh rate.

Caution

- Depending on the display refresh rate and baud rate, all data may not be transmitted unless the baud rate is increased.

19.1.4. Interval mode

- Regardless of whether the stabilization indicator is turned on or not, the weighing value will be output at the interval specified for [Interval time] in the [Data output mode] screen of the function table. Press the **PRINT** button  to start output, and press the **PRINT** button  again during output to stop it.
- In the Interval output mode, strings **START** and **STOP** are added to the **PRINT** button  in the HOME screen.

Caution

- Depending on the combination of "Interval time" and "Baud rate", all data may not be transmitted unless the baud rate is increased.

19.2. Weighing data format

Selecting weighing data format





- You can select the output format for the RS-232C connection in the [RS-232C interface] screen. For configuration details, refer to “13.13. RS-232C interface”.

MENU key  → System settings button  → Communication button  → RS-232C interface button  → In the [RS-232C interface] screen, select the output format.





- You can select the output format for the USB connection in the [USB interface] screen. For configuration details, refer to “13.14. USB interface”.

MENU key  → System settings button  → Communication button  → USB interface button  → In the [USB interface] screen, select the output format.

- You can select the output format for the LAN connection in the [Wired LAN] screen. For configuration details, refer to “13.15. Wired LAN”.

MENU key  → System settings button  → Communication button  → Wired LAN button  → In the [Wired LAN] screen, select the output format.

- You can select the output format for the Bluetooth connection in the [Bluetooth] screen. For configuration details, refer to “13.16. Bluetooth”.

MENU key  → System settings button  → Communication button  → Bluetooth button  → In the [Bluetooth] screen, select the output format.

A&D standard format

- This is the standard format for sending data to peripheral devices.
- Consists of 16 characters (not including the terminator).
- The condition of the data is indicated with a 2-character header.
- The data is padded with polarity and zeros (filling the data's higher order's surplus part with zeros).
- If the data is zero, the polarity is positive.
- The unit consists of three characters.

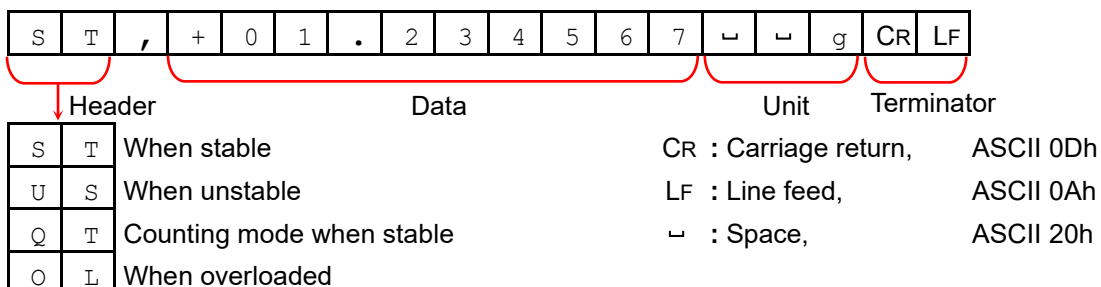

- In the external key print mode of the AD-8127 multi-functional compact printer, a received A&D standard format is printed as shown on the right.

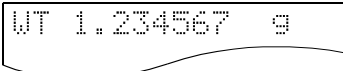

- If the gross/tare weight is added in the [Data to be added] screen of the function table, the second header corresponding to the output data is appended to the header.

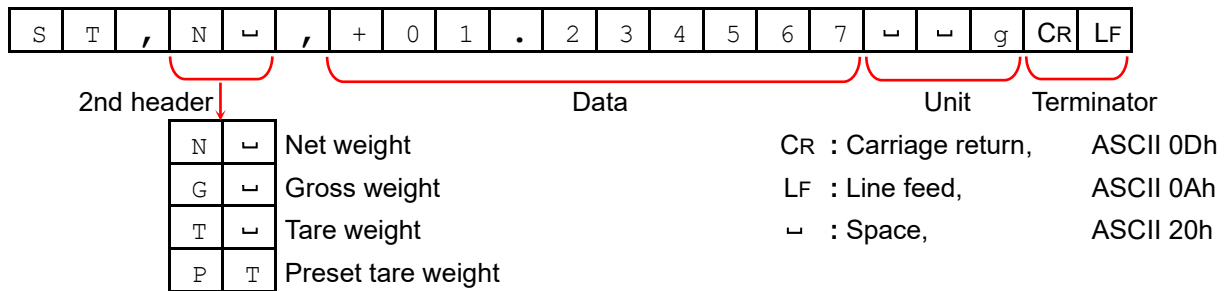

Display settings: MENU key → System settings button → Communication button → Data output button → Data to be added button → [Data to be added] screen

DP format (dump print)

- This format is suitable for dump printing.
- Consists of 16 characters (not including the terminator).
- The condition of the data is indicated with a 2-character header.
- The polarity sign is added right before the value if it is not an overload or zero.
- The data is zero-suppressed (leading zeros are replaced with spaces).
- The unit consists of three characters.

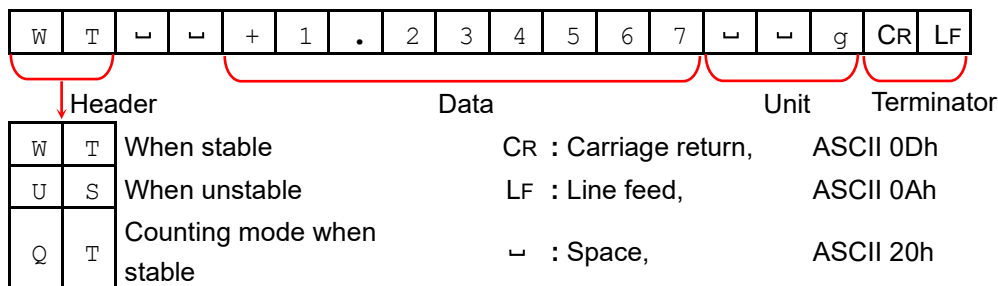

KF format

- This is the Karl-Fischer moisture meter format.
- Consists of 14 characters (not including the terminator).
- There are no headers.
- The polarity sign is added to the first character if it is not an overload or zero.
- The data is zero-suppressed (leading zeros are replaced with spaces).
- When stable, the unit is output. When not stable, the unit is not output.

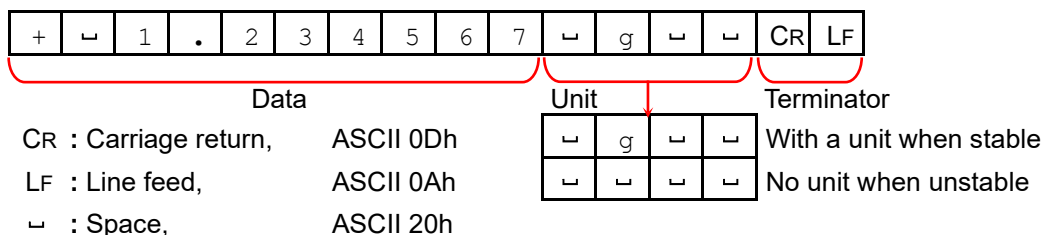

CSV format

- The data part and unit part of the A&D standard format are separated by a separator ",".
- Outputs the unit even when overloaded.
- When the decimal comma (,) is set, a semicolon (;) will be used instead as a separator.

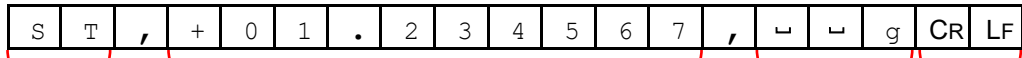



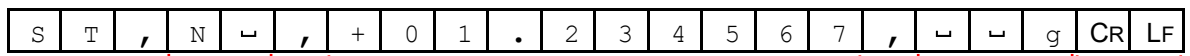

Header		Data	Unit	Terminator
S	T	When stable	CR : Carriage return,	ASCII 0Dh
U	S	When unstable	LF : Line feed,	ASCII 0Ah
Q	T	Counting mode when stable	␣ : Space,	ASCII 20h
O	L	When overloaded		

- If the gross/tare weight is added in the [Data to be added] screen of the function table, the second header corresponding to the output data is appended to the header.



2nd header		Data	Unit	Terminator
N	␣	Net weight	CR : Carriage return,	ASCII 0Dh
G	␣	Gross weight	LF : Line feed,	ASCII 0Ah
T	␣	Tare weight	␣ : Space,	ASCII 20h
P	T	Preset tare weight		

Display settings: MENU key  → System settings button  → Communication button  → Data output button  → Data to be added button  → [Data to be added] screen

- When other data is added to the weighing value, all data will be output in one line. The output sample will be as follows if the ID number, data number, date and time are added.

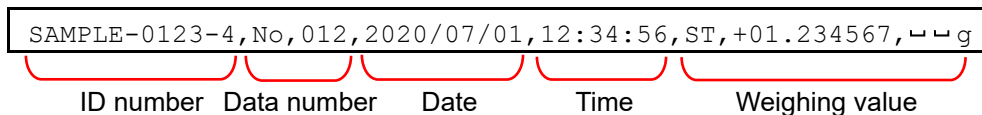

TAB format

- This is a format, in which the separator of the CSV format is changed from comma to TAB.
- Used when connecting to a personal computer and inputting to Excel and the like.

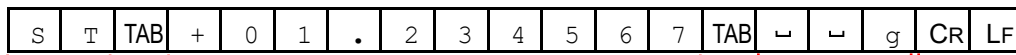

Header		Data	Unit	Terminator
S	T	When stable	CR : Carriage return,	ASCII 0Dh
U	S	When unstable	LF : Line feed,	ASCII 0Ah
Q	T	Counting mode when stable	␣ : Space,	ASCII 20h
O	L	When overloaded	TAB : Horizontal tab,	ASCII 09h

19.2.1. Output examples of weighing data format

When stable

○ 1.234567 g

A&D	S	T	,	+	0	1	.	2	3	4	5	6	7	▬	▬	g	CR	LF
DP	W	T	▬	▬	+	1	.	2	3	4	5	6	7	▬	▬	g	CR	LF
KF	+	▬	1	.	2	3	4	5	6	7	▬	g	▬	▬	CR	LF		
MT	S	▬	▬	▬	1	.	2	3	4	5	6	7	▬	g	CR	LF		
NU	+	0	1	.	2	3	4	5	6	7	CR	LF						
NU2	1	.	2	3	4	5	6	7	CR	LF								

When unstable

-0.012345 g

A&D	U	S	,	-	0	0	.	0	1	2	3	4	5	▬	▬	g	CR	LF
DP	W	T	▬	▬	-	0	.	0	1	2	3	4	5	▬	▬	g	CR	LF
KF	-	▬	0	.	0	1	2	3	4	5	▬	▬	▬	▬	CR	LF		
MT	S	D	▬	-	0	.	0	1	2	3	4	5	▬	g	CR	LF		
NU	-	0	0	.	0	1	2	3	4	5	CR	LF						
NU2	-	0	.	0	1	2	3	4	5	CR	LF							

When overloaded
(positive)

E

A&D	O	L	,	+	9	9	9	9	9	9	9	9	E	+	1	9	CR	LF
DP	▬	▬	▬	▬	▬	▬	▬	▬	E	▬	▬	▬	▬	▬	▬	▬	CR	LF
KF	▬	▬	▬	▬	▬	▬	H	▬	▬	▬	▬	▬	▬	▬	▬	▬	CR	LF
MT	S	I	+	CR	LF													
NU	+	9	9	9	9	9	9	9	9	CR	LF							
NU2	+	9	9	9	9	9	9	9	9	CR	LF							

When overloaded
(negative)

-E

A&D	0	L	,	-	9	9	9	9	9	9	9	9	E	+	1	9	CR	LF	
DP	␣	␣	␣	␣	␣	␣	␣	-	E	␣	␣	␣	␣	␣	␣	␣	␣	CR	LF
KF	␣	␣	␣	␣	␣	␣	L	␣	␣	␣	␣	␣	␣	␣	␣	␣	␣	CR	LF
MT	S	I	-	CR	LF														
NU	-	9	9	9	9	9	9	9	9	9	CR	LF							
NU2	-	9	9	9	9	9	9	9	9	9	CR	LF							

Unit code

Unit	A&D	DP	KF	MT
g	␣ ␣ g	␣ ␣ g	␣ g ␣ ␣	␣ g
mg	␣ m g	␣ m g	␣ m g ␣	␣ m g
PCS	␣ P C	␣ P C	␣ p c s	␣ P C S
%	␣ ␣ %	␣ ␣ %	␣ % ␣ ␣	␣ %
ct	␣ c t	␣ c t	␣ c t ␣	␣ c t
mom	m o m	m o m	␣ m o m	␣ m o

ct stands for "carat" and mom stands for "momme".

ASCII code symbols

- CR : Carriage return, ASCII 0Dh
- LF : Line feed, ASCII 0Ah
- ␣ : Space, ASCII 20h
- TAB : Horizontal tab, ASCII 09h

19.2.2. Other data formats

In addition to weighing data, various data can be added.

Change the ON/OFF of each setting in the function table as necessary.

ASCII code symbols

CR : Carriage return, ASCII 0Dh ␣ : Space, ASCII 20h
LF : Line feed, ASCII 0Ah

Data number output

- When the statistical calculation function is used, the data number is output.
- Consists of 6 characters (not including the terminator).
- When the NU or NU2 format is selected with the Quick USB mode, only the decimal point "." and number are output.

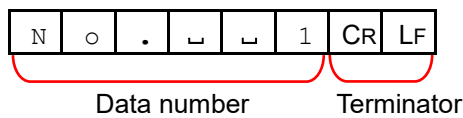

Quick USB connection (outputting the numerical values only)

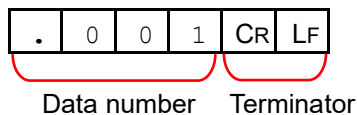

ID number

- The ID number stored in the balance is output.
- Consists of 13 characters (not including the terminator).
- When the NU or NU2 format is selected with the Quick USB mode, only the hyphen " - " and number are output.

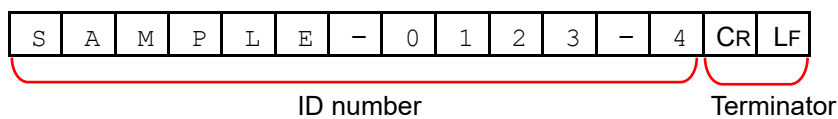

Quick USB connection (outputting the numerical values only)

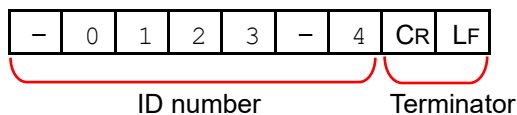

Date

- Outputs the date from the clock data of the balance.
- The order of YYYY/MM/DD can be changed in the setting.
- Consists of 10 characters (not including the terminator).
- When the NU or NU2 format is selected with the Quick USB mode, "." is output instead of "/".

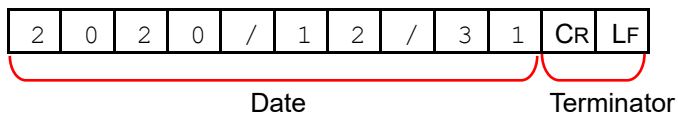

Quick USB connection (outputting the numerical values only)

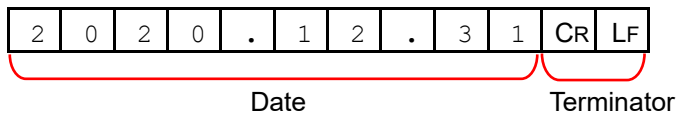

Time

- Outputs the time from the clock data of the balance.
- 24-hour format.
- Consists of 10 characters (not including the terminator).
- When the NU or NU2 format is selected with the Quick USB mode, "." is output instead of ":".

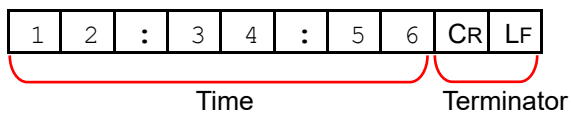

Quick USB connection (outputting the numerical values only)

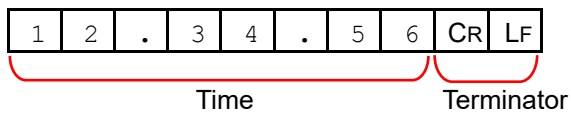

20. Command

By sending the specified commands from a personal computer or a PLC to the balance, it is possible to control the balance to perform "weighing data request", "key operations", "setting value change", etc. To send a command to the balance, add a terminator (CR LF or CR) to the command character string. You can set the terminator in the [Command settings] screen described in "13.11. Command settings".

ASCII code symbols

CR	: Carriage return,	ASCII 0Dh	LF	: Line feed,	ASCII 0Ah
<ESC>	: Escape,	ASCII 1Bh	␣	: Space,	ASCII 20h





20.1. Control commands

Commands to query weighing data

Command	Description
Q	Requests the weighing data immediately
RW	Requests the weighing data immediately
SI	Requests the weighing data immediately
S	Requests the weighing data when stabilized.
<ESC>P	Requests the weighing data when stabilized.
SIR	Requests the weighing data continuously. (Stream output)
C	Cancels the S, <ESC>P, or SIR command.

- The Q, RW, and SI commands have the same function. The S, <ESC>, and P commands have the same function.

Key control commands

Command	Description
P	Same as the ON:OFF key  .
ON	Turns the display on.
OFF	Turns the display off.
CAL	Sensitivity adjustment using the internal weight
EXC	Sensitivity adjustment with an external weight.
PRT	Same as the PRINT button  .
R	Same as the RE-ZERO button  .
RZ	
T	Same as the TARE button  .
TR	
ZR	Zero If the load is within $\pm 2\%$ of the capacity from the initial zero point, the zero point is updated, the tare value is cleared and the display is set to zero. If the load exceeds $\pm 2\%$, no processing is done.
RIR	Same as the IR sensor (right).
LIR	Same as the IR sensor (left).
TST	Performs calibration test with the internal weight.

- The R and RZ commands have the same function.
 □ The T and TR commands have the same function.

Commands to preset the tare value

Command	Description
PT:*.***** <input type="text"/> g	<p>Sets the preset tare value.</p> <p>Add the unit in the A&D standard format (3 characters).</p> <p>If the display unit is PCS or percent (%), set the value in gram.</p> <p>In the case of setting the preset tare value to 1.23456 g, the input will be <input type="text" value="PT:1.23456"/>g.</p> <p>Values exceeding the weighing capacity cannot be set. Negative values cannot be set.</p>
?PT	<p>Requests the tare weight value.</p> <p>Outputs the tare value set with the PT, T, or TR command.</p>

Commands to control piece counting

Command	Description
UW:*.***** <input type="text"/> g	<p>Sets the unit weight value (weight of one piece).</p> <p>Add the unit in the A&D standard format (3 characters).</p> <p>In the case of setting the unit weight value to 1.23 g, the input will be <input type="text" value="UW:1.23"/>g.</p> <p>Values exceeding the weighing capacity cannot be set. Negative values cannot be set.</p>
?UW	Requests the unit weight value.

Commands to set time and date

Command	Description
TM:*.*.*.*	<p>Sets time.</p> <p>In the case of setting time to "twelve thirty-four fifty-six seconds", the input will be <input type="text" value="TM:12:34:56"/>.</p> <p>Do not set non-existing time values.</p>
DT:*/*/**	<p>Sets date.</p> <p>In the case of setting time to "January 23, 2020", the input will be <input type="text" value="DT:20/01/23"/>.</p> <p>Do not set non-existing date values.</p>
?TM	Requests the time.
?DT	Requests the date.

Commands to open and close the door (with the touch panel software version 1.019 or later)

Command	Description
RD:000	Closes the right door.
RD:001	Opens the right door.
LD:000	Closes the left door.
LD:001	Opens the left door.
?RD	Requests the status of the right door. RD,000 Closed RD,001 Opened
?LD	Requests the status of the left door. LD,000 Closed LD,001 Opened

Commands to request other data

Command	Description
?T	Requests the tare weight value. Outputs the tare value set with the T or TR command.
?ID	Requests the ID number.
?SN	Requests the serial number.
?TN	Requests the device name.



20.2. AK code and error codes

When [AK (acknowledge), error code] is set to ON in the [Command settings] screen described in “13.11. Command settings”, the balance always responds to reception of all commands sent from a personal computer or a PLC. Checking the code that is responded improves the reliability of the communication.

Balance response

When [AK (acknowledge), error code] is set to ON, the balance responds as follows.

- When the balance receives a command requesting data:
If the balance can output the data, it sends the requested data.
If the balance cannot output the data, it sends an error code (EC,Exx).
- When the balance receives a control command:
The balance will send an AK code (acknowledgment, ASCII 06h) upon confirmation of receipt of the command and completion of the process.
If the balance cannot execute the command, it sends an error code (EC, Exx).
- The following control commands are handled by the balance, which sends an AK code (acknowledgment, ASCII 06h) upon the completion of the process as well as upon confirmation of receipt of the command.
If the balance cannot execute the command process, it sends an error code (EC, Exx). To clear the error, use the CAL command.

Command	Description
ON	Turns the display on.
P	Turns the display on/off. (Only when the display is on.)
R, RZ	Same as the  button.
T, TR	Same as the  button.
ZR	Zero If the load is within $\pm 2\%$ of the capacity from the initial zero point, the zero point is updated, the tare value is cleared and the display is set to zero. If the load exceeds $\pm 2\%$, no processing is done.
CAL	Sensitivity adjustment with the internal weight.
EXC	Sensitivity adjustment with an external weight.
TST	Performs calibration test with the internal weight.
RD:000	Closes the right door.*
RD:001	Opens the right door.*
LD:000	Closes the left door.*
LD:001	Opens the left door.*

* Supported with the touch panel software version 1.019 or later

20.3. Command usage examples

In the following command examples, [AK (acknowledge), error code] is set to ON in the [Command settings] screen described in “13.11. Command settings” so that the balance outputs an AK code (acknowledgment, ASCII 06h) when it processes the command successfully.

ASCII code symbols

CR : Carriage return, ASCII 0Dh

LF : Line feed, ASCII 0Ah

␣ : Space, ASCII 20h

AK : Acknowledgment, ASCII 06h

Example of the ON command (Turning the display on)

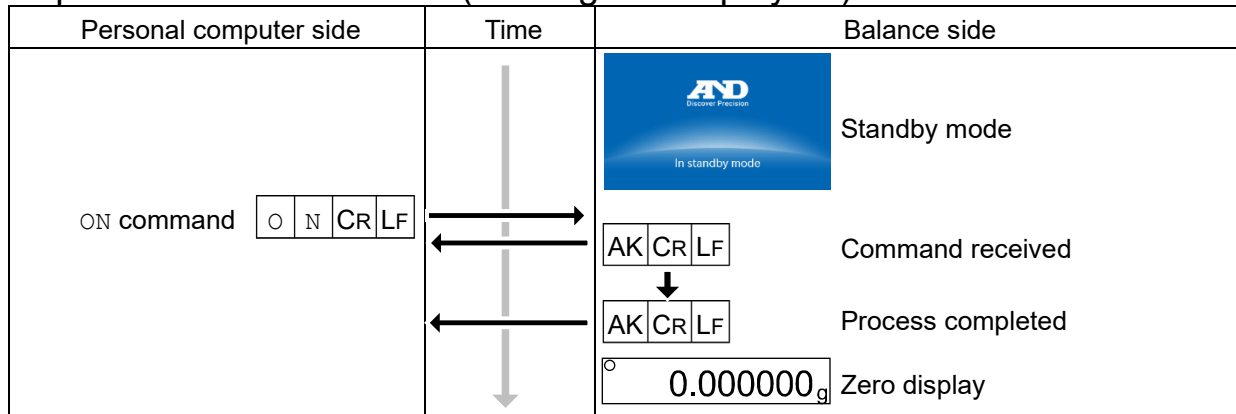

Example of the R command (Re-zero)

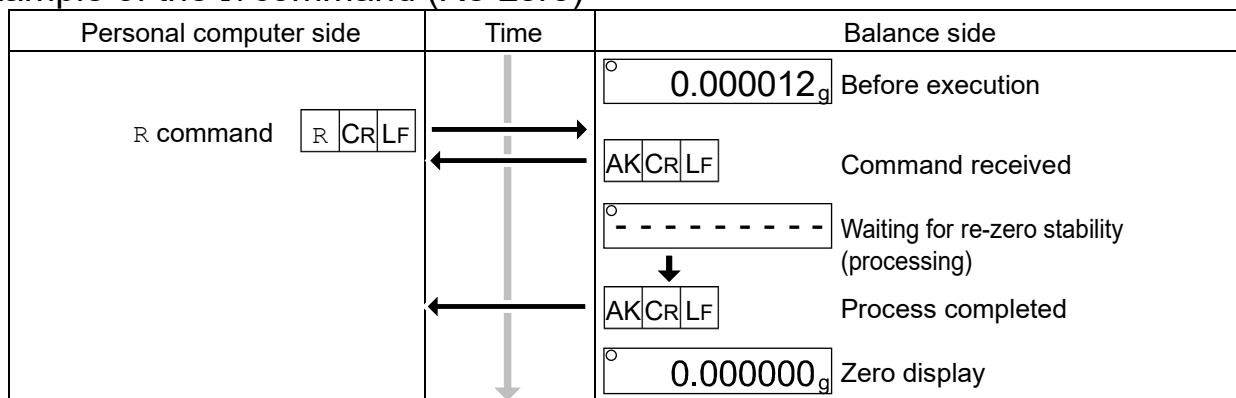

Example of the CAL command (Sensitivity adjustment with the internal weight)

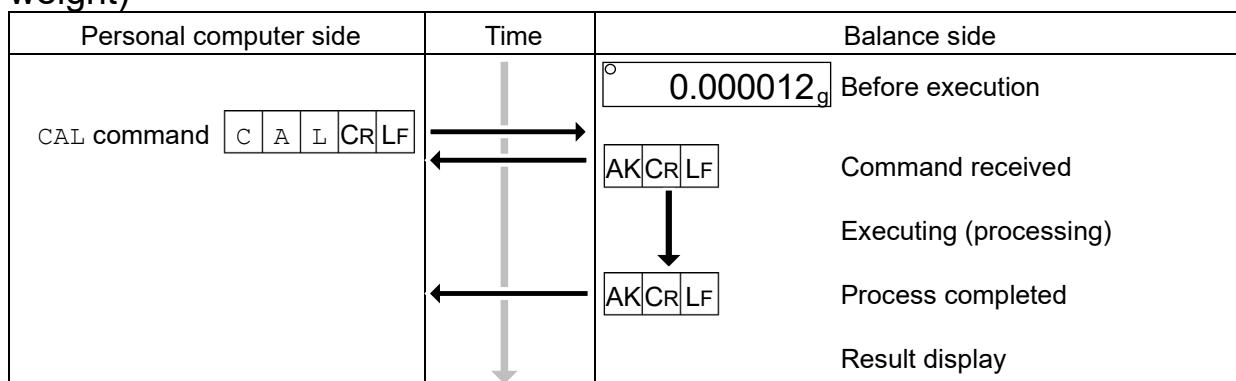

Example of weighing with tare function

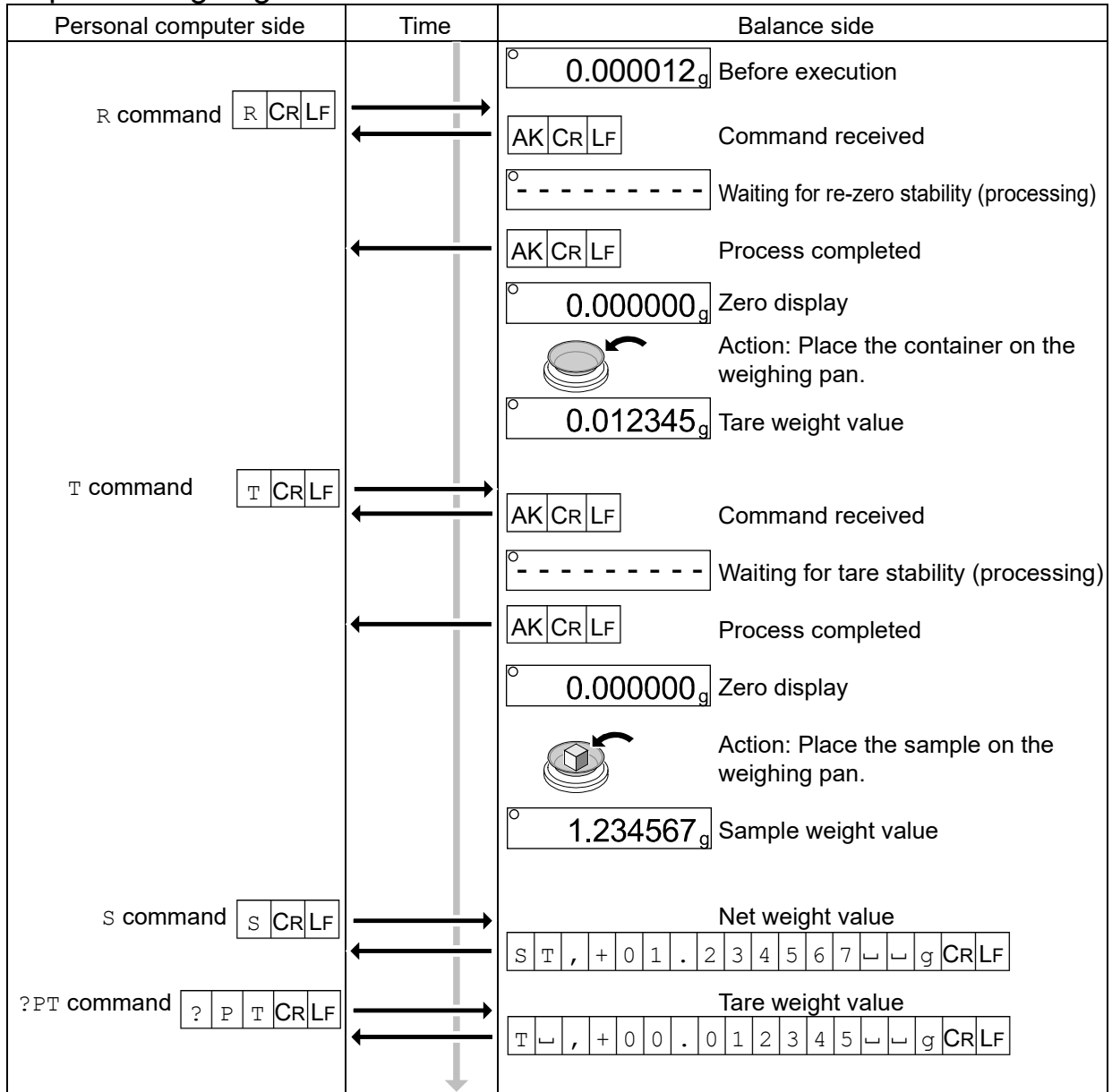

21. UFC Function

- The UFC (Universal Flex Coms) function allows you to output contents of your choice when outputting the weighing data. You can also output a character string when printing a barcode with a label printer or the like.
- In order to use the UFC function, it is necessary to set the output data format used to [UFC format]. For the data format settings, refer to “13.13. RS-232C interface”, “13.14. USB interface”, “13.15. Wired LAN”, and “13.16. Bluetooth”.

21.1. UFC program commands

- The output data format used can be stored in the balance by sending the program command from a personal computer.
- Text files can be imported from a USB flash drive to the internal memory. For the import method, refer to “13.17. UFC format”.
- The program command received is saved in the internal memory with the filename “Received_Program_Command.txt”. The data in the internal memory is stored even when the power of the balance is turned off. However, when the program command is received again, the file will be overwritten.

Creating program commands

- The maximum number of characters for a program command is 1024 characters.
- Add the three characters “PF,” to the beginning of the program command.
- Program commands are combined using comma or space delimiters, which can be omitted to reduce the number of characters. The comma after the PF command, however, cannot be omitted.

Program command list

Command	Function	Output example
PF,	UFC command header Added to the beginning of the program command.	
\$MN	Manufacturer name	□ □ □ □ □ □ □ A □ & □ □ D
\$TY	Model name	□ □ □ □ □ □ □ B A - 6 T E
\$SN	Serial number	□ □ □ □ T 1 2 3 4 5 6 7
\$ID	ID number	S A M P L E - 1 2 3 4 - 5
\$DT	Date	2 0 2 1 / 1 0 / 0 1
\$TM	Time	1 2 : 3 4 : 5 6
\$WT	Weighing data	□ □ + 0 . 2 3 4 5 6 7 □ □ g
\$GR	Gross data (gross weight)	□ □ + 1 . 2 3 4 5 6 7 □ □ g
\$NT	Net data (net weight)	□ □ + 0 . 2 3 4 5 6 7 □ □ g
\$TR	Tare data (tare weight)	□ □ + 1 . 2 3 4 5 6 7 □ □ g
\$PC	Counting data	□ □ □ □ □ □ + 1 2 3 4 □ P C
\$UW	Unit weight data	□ □ □ □ □ □ + 0 . 1 2 □ □ g
\$CM	Comma	,
\$SP	Space, ASCII 20h	□
\$CR	Carriage return, ASCII 0Dh	CR
\$LF	Line feed, ASCII 0Ah	LF
\$NU	Outputs a weighing value in the NU2 format*	0 . 2 3 4 5 6 7
\$HT	Outputs a tab*	TAB

* Supported with the touch panel software version 1.019 or later

- Enclose an ASCII code string of your choice in single quotation marks. Character strings that can be output are comprised of alphanumeric characters and symbols. The single quotation mark is represented by two single quotation marks.
Example. Character string for outputting A'BC'D is 'A' 'BC' 'D'.
- To output the ASCII control code, enter "# + 2 hexadecimal characters"
However, SOH (01h), STX (02h), ETX (03h), and EOT (04h) cannot be used.
Example. To output the ASCII code " acknowledgement, AK (06h)", enter #06.
- By adding \'* and a number (up to 2 characters)' after the command, space (\$SP), CR (\$CR), and LF (\$LF) can be repeated as many times as the number entered.
Example. To output 12 spaces, enter \$SP*12.
To output 9 CRs, enter \$CR*9.
- By adding '&' to the end of a line when sending two or more lines of program command, the balance determines that the program command will continue on the next line.
- The balance sends an <AK> code (acknowledgement, ASCII 06h) at the end of the process.
If the command cannot be executed, an error code (EC, Exx) will be sent.
- The software "Windows Communication Tools for UFC" ("WinCT-UFC") for creating program commands is available.
Download "WinCT-UFC" from our website (<https://www.aandd.jp>).

ASCII code symbols

CR : Carriage return	ASCII 0Dh	LF : Line feed	ASCII 0Ah
␣ : Space	ASCII 20h	AK : Acknowledgment	ASCII 06h

21.1.1. Examples of UFC program command creation

Note See the previous page for the meanings of UFC commands and symbols.

For the data output format, refer to "19. Data Output".

The following examples "SAMPLE01.txt" and "SAMPLE02.txt" are saved in the Balance's memory.

Example 1 SAMPLE01.txt

Output	Contents	Program command example
NET	Character string 'NET', Line feed	PF, 'NET', \$CR, \$LF, &
␣␣␣␣␣␣␣␣+0.234567␣␣g	Space×6, Net data, Line feed	\$SP*6, \$NT, \$CR, \$LF, &
TARE	Character string 'TARE', Line feed	'TARE', \$CR, \$LF, &
␣␣␣␣␣␣␣␣+1.000000␣␣g	Space×6, Tare data, Line feed	\$SP*6, \$TR, \$CR, \$LF, &
GROSS	Character string 'GROSS', Line feed	'GROSS', \$CR, \$LF, &
␣␣␣␣␣␣␣␣+1.234567␣␣g	Space×6, Gross data	\$SP*6, \$GR, \$CR, \$LF
		Terminator

Example 2 SAMPLE02.txt

Output	Contents	Program command example
2020/09/01 12:34:56	Date, Time, Line feed	PF, \$DT, \$TM, \$CR, \$LF, &
SAMPLE␣␣␣␣␣␣␣␣ABC-123	Character string 'SAMPLE␣␣␣␣␣␣␣␣ABC-	'SAMPLE␣␣␣␣␣␣␣␣ABC-123', \$CR, \$LF, &
WEIGHT␣␣␣+2.345678␣␣g	123', Line feed	'WEIGHT', \$WT, \$CR, \$LF
	Character string 'WEIGHT␣␣␣␣␣␣',	Terminator
	Weight data	

22. Key Lock Function

- The key switches of the balance and the IR sensor functions can be locked by sending a specified command to the balance. This is a useful function when you want to control the balance only with an external device such as a personal computer.
Even in the key lock state, it is possible to operate the keys with the key control commands. For the key control commands, refer to “20. Command”.
- Key lock state can be checked by sending a command to check the state to the balance.
- Key lock is maintained until either a command is sent to the balance to release or the power is turned off by unplugging the AC adapter.
- The key lock command operates only on the HOME screen (weighing mode, counting mode, percent mode, minimum weight alert function). Although the key lock command operates in compounding mode and HPLC mode, you cannot operate the balance with the command (the **SAVE** button  or recipe selection).

Caution The IR sensor settings cannot be changed in the key lock state.

22.1. Locking all key switches

All the key switches of the balance can be disabled by sending a **KL** command to the balance.

Command string	Function
?KL	Requests key lock state
	KL,000 Keys unlocked
	KL,001 Keys locked
KL:****	In place of ***, 000 or 001 is entered.
	KL:000 Keys locked
	KL:001 Key lock set

22.2. Sensitivity adjustment while the keys are locked

The following commands are enabled on the sensitivity adjustment screen while the keys are locked.

Command string	Description
NEXT	Confirms the current input and proceeds to the next instruction. Operates the same as the [Enter] button  .
BACK	Displays the [HOME] screen. Operates the same as the [Back] button.

22.2.1. Procedure for external sensitivity adjustment while the keys are locked

Weighing example for BA-6DTE

- Step 1. Make sure that nothing is on the weighing pan, and then send the [NEXT] command. The balance measures the zero point.
Do not apply vibration and the like to the balance.
✘ You can input the external weight value before input.

- Step 2. Place the weight on the weighing pan, and then send the [NEXT] command.
Measure the weight.
Do not apply vibration and the like to the balance.
✘ You can input the external weight value before input.

- Step 3. The [Sensitivity adjustment result] screen for the external sensitivity adjustment is automatically displayed. Please remove the weight.

- Step 4. The result screen is displayed.
✘ The result is automatically output if [GLP output] in [Data output] is set to ON.

- Step 5. Send the [BACK] command to return to the weighing screen.
Place the weight again to confirm that the sensitivity of the balance is adjusted properly.
If it is not within the range, start over from the first step of this procedure in the appropriate ambient conditions.

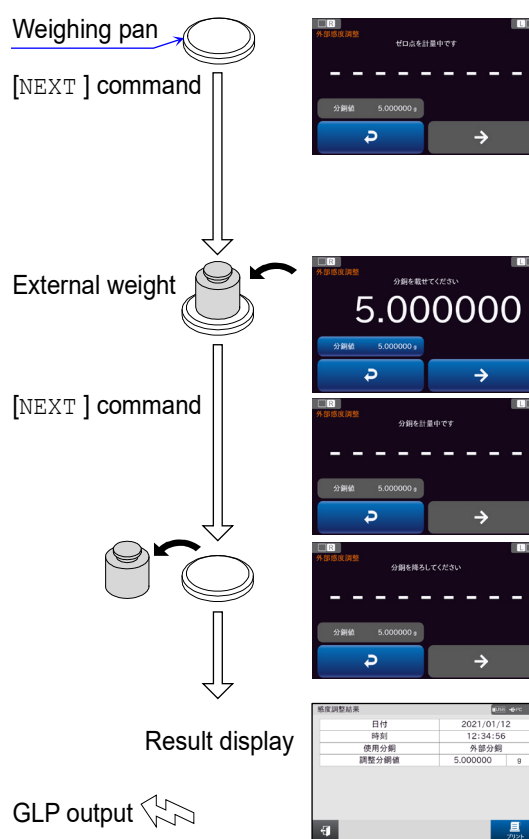

23. Error Codes

23.1. Error code list

Error Display	Error Code	Description and possible countermeasure
	EC, E00	Communications error A protocol error occurred in communications. Check the format, baud rate, and parity.
	EC, E01	Undefined command error An undefined command was found. Check the transmitted command.
	EC, E02	Not ready The received command cannot be executed: (e.g.) Q command was received when not in weighing mode. (e.g.) Q command was received while re-zeroing. Adjust the delay time to transmit a command.
	EC, E03	Timeout error With the command timeout setting, there was a wait time of approximately 1 second or more while receiving command characters. Check the communication.
	EC, E04	Character length error The number of characters in the received command has exceeded the limit. Check the command to transmit.
	EC, E06	Format error The description of the received command is incorrect: (e.g.) The number of digits of numerical values is incorrect. (e.g.) There are alphabet characters among the numerical values. Check the transmitted command.
	EC, E07	Parameter setting error The value of the received command has exceeded the allowed value. Check the setting range of the numerical value of the command.
Error 1	EC, E11	Stability error Weighing value is unstable and therefore the “zero display”, “sensitivity adjustment”, “calibration test”, etc. cannot be executed. Check around the pan. Improve the environment of the installation location to prevent factors such as vibration, draft, temperature change, static electricity and magnetic field from influencing the balance. Wait for 10 seconds to clear the error.
Error 2		Out of the setting range The value to be set exceeds the setting range. Set again within the setting range.
Error 3		Malfunction of the internal memory element of the balance If this error continues to be displayed, repair is necessary. Please contact your local dealer for repair.

Error Display	Error Code	Description and possible countermeasure
Error 6	EC, E16	Internal weight error Applying the internal weight does not yield a change in the mass value as specified. Confirm that there is nothing on the pan and perform the operation from the beginning.
Error 7	EC, E17	Internal weight error The internal weight application mechanism does not function properly. Perform the operation from the beginning.
Error 8		Abnormality in the internal memory data of the balance If this error continues to be displayed, repair is necessary. Please contact your local dealer for repair.
Error 9		Abnormality in the internal memory data of the balance If this error continues to be displayed, repair is necessary. Please contact your local dealer for repair.
Error 16		Internal weight error Applying the internal weight did not yield a weight change. Make sure that there is nothing on the weighing pan and perform the same operation again.
Error 17		Internal weight error The internal weight application mechanism does not function properly. Perform the operation from the beginning.
Error 20		Sensitivity adjustment weight error (heavy) The weight is too heavy. Check the nominal value of the weight. Send the CAL command or wait for 5 seconds to clear the error.
Error 21		Sensitivity adjustment weight error (light) The weight is too light. Check the nominal value of the weight. Send the CAL command or wait for 5 seconds to clear the error.
CAL E	EC, E20	Sensitivity adjustment weight error (Positive value) The weight is too heavy. Check around the pan. Check the mass value of the weight.
-CAL E	EC, E21	Sensitivity adjustment weight error (Negative value) The weight is too light. Check around the pan. Check the mass value of the weight.
Con Err		Weighing unit error Data from the weighing unit has not been received. Check the connection between the weighing unit and the display unit, and turn the power off and then on again.
Door Err		Breeze break error Communication with the breeze break is not possible. Unplug the power supply and reconnect the cable between the breeze break unit and the weighing unit.
S/N Error		Serial number error The serial numbers of the weighing unit and the display unit do not match. Reconnect with the correct combination.

Error DisplayError Code	Description and possible countermeasure
Weighing display E	Overload error A sample beyond the balance weighing capacity has been placed on the pan. Remove the object from the pan.
Weighing display -E	Weighing pan error The weighing value is too light. Check that the weighing pan is installed correctly. Set the weighing pan correctly. Perform sensitivity adjustment.
Weighing display Lo	Sample mass error The sample is too light to be stored as a sample mass for the counting mode or percent mode.
rtc PF	Clock battery error The clock backup battery has been depleted. Set the time and date. Even if the clock backup battery is depleted, the clock and calendar function works normally as long as the balance is powered with the AC adapter. If this error appears frequently, contact your local dealer.
LoWVoLt	Power supply voltage fault The voltage supplied from the AC adapter is abnormal. Check that the AC adapter is the one supplied with the balance (refer to “ 27. Specifications ”).
SD Error	Repeatability error <input type="checkbox"/> SD Error The standard deviation (SD) of repeatability exceeded 50 d. Review the installation environment of the balance.

"d" is a unit of readability.

24. Ionizer

The ionizer removes static electricity by irradiating the target object with positive or negative ions that are generated from four discharge electrodes by DC corona discharge. Ordinarily, insulators such as powders, filters, or weighing paper, tend to be charged when the humidity is 45% RH or less, and an error of a few milligrams may occur during weighing. By removing static from the weighing object with the ionizer, it is possible to eliminate the error in the weighing value due to charging, and correct weighing can be performed.

24.1. Usage

- Step 1. Make sure that the AC adapter of the balance is not connected, and then connect the balance and the ionizer (as noted in “2.2. Assembly and installation”).
- Step 2. Connect the AC adapter, plug it in, and then turn on the power. The power lamp of the ionizer lights up.
- Step 3. Place the target object within the effective range of static elimination.
- Step 4. Hold your hand over the IR sensor (touchless infrared proximity sensor) on the front of the ionizer to start static elimination. The ION lamp indicating that static elimination is in progress lights up.
- Step 5. Refer to the figure below for the effective range of static elimination, and perform static elimination. At factory setting, when three seconds have passed from the start of static elimination, the ION lamp indicating that static elimination is in progress turns off and static elimination stops.

Ionizer

IR sensor (touchless infrared proximity sensor)

Power lamp (lights up when the power is turned on)

ION lamp (lights up during static elimination)

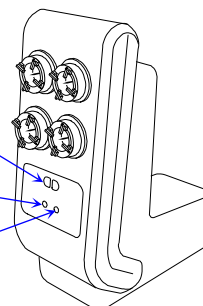

Effective range of static elimination

Top view

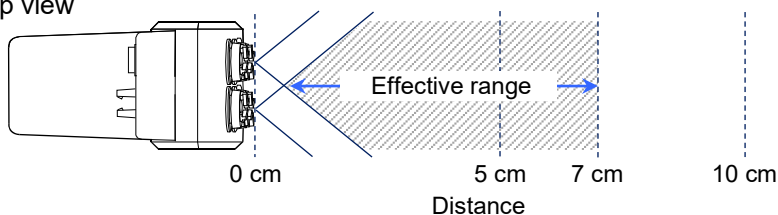

Side view

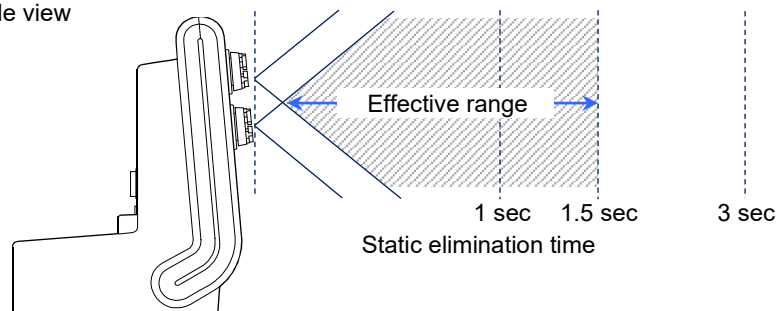

24.2. Optimizing the Ionizer

Static elimination method can be optimized with the switches on the rear. Refer to the following table for the functions of switches. Change the settings of switch 1 and switch 2 as shown in the table when eliminating static electricity out of the effective range.

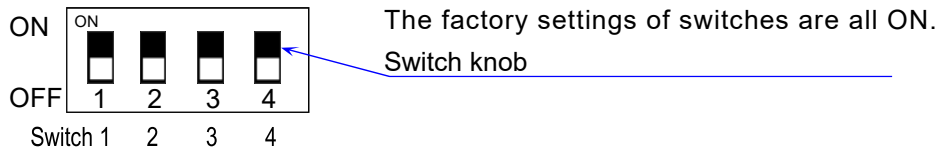

The factory settings of switches are all ON (upper side). It means static elimination method is in 'timer mode,' 'discharging time' is for 3 seconds, and 'built-in IR sensor' and 'buzzer' are available.

Switch No. / Item	Switching location	Description
Switch 1 Static elimination method	ON Upper side	Timer mode ^{*1}
	OFF Lower side	Manual mode ^{*2}
Switch 2 Discharging time ^{*3}	ON Upper side	3 seconds
	OFF Lower side	10 seconds
Switch 3 Built-in IR sensor	ON Upper side	Available
	OFF Lower side	Not available
Switch 4 Buzzer ^{*4}	ON Upper side	Available
	OFF Lower side	Not available

- ^{*1} When the 'timer mode' is selected with switch 1, static elimination is performed for the 'discharging time' set with switch 2.
- ^{*2} When the 'manual mode' is selected with switch 1 and static elimination starts, it continues until the built-in IR sensor or the optional IR switch performs again. The 'manual mode' does not stop static elimination automatically.
- ^{*3} Discharging time is settable only when the static elimination mode is in the 'timer mode' (switch 1 is on).
- ^{*4} Buzzer rings when the power is turned on or whenever the IR sensor or IR switch performs.

24.3. Maintaining the ionizer

Caution: Do not touch electrode units while the ionizer is in operation. Doing so may result in electric shock.

- Dust and other substances adhere to the electrode needle area of the ionizer over time, degrading the static elimination capacity. To maintain the performance, clean the electrode needle on electrode units with a dry cotton swab, etc. on a regular basis.
- If the static elimination capacity does not recover because the tip of the electrode needle on an electrode unit is worn out, replace all of the four electrode units with new ones. The lifetime of electrode units is approx. 10000 hours.

Replacement procedure

- Step 1. Disconnect the balance connection cable and turn off the power.
- Step 2. Rotate electrode units counterclockwise by 45° to pull them out.
- Step 3. Insert new electrode units and rotate them clockwise by 45° to secure them.

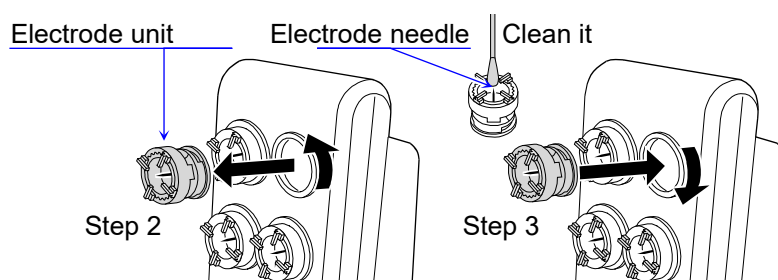

25. Maintenance

25.1. Treatment of the balance

- When cleaning the balance, wipe it with a lint free cloth that is moistened with a little neutral detergent.
- Do not use organic solvents or chemical cleaning cloths to clean the balance.
- Do not disassemble the balance.
- When transporting the balance, use the packing material and box that the balance was contained at the time of purchase.

For transportation, remove the following parts from the balance main body:

Weighing pan parts (weighing pan, pan support, dust plate, breeze break ring, breeze break bottom plate)

Small glass breeze break parts (side panes (3), top pane, base stand)

Breeze break front glass, breeze break doors, breeze break top door, attached cables

26. Troubleshooting

26.1. Checking the balance performance and environment

- Since the balance is a precision instrument, in some cases it may not be able to measure correct values due to adverse effects of the measurement environment or measurement method.
If repeatability is poor when the sample is loaded and unloaded several times, or if the balance seems to be operating abnormally, check the following items. If the problem persists after checking each item, contact your local A&D dealer for repair. "Frequently Asked Questions" and answers to them are also posted on our website (<https://www.aandd.jp>).

1. Checking that the balance works properly

- Method 1 Use check functions to check the balance operation. Refer to "11.1. Daily check" and "11.2. Periodic check". Fatal failures are displayed as a message.
- Method 2 As a simpler test, check the repeatability with an external weight.
Be sure to place the weight in the center of the weighing pan.
- Method 3 As a precise test, check the repeatability, linearity, weighing value, etc. with a weight of a known weight.

2. Checking that the measurement environment and method are appropriate

Check the following check items.

Operating environment

- Is the table on which the balance is placed sturdy? (Specifically for BA-6TE, BA-6DTE)
- Is the balance level? For how to adjust the bubble spirit level, refer to "2.3. Installation considerations, preparation and precautions".
- Is the operating environment free from vibration and drafts?
- Is there any strong electrical or magnetic noise source such as a motor near the balance?

Weighing method

- Is the weighing pan set so that it does not touch other parts such as the breeze break and dust plate frame? (Is it installed correctly?)
- Do you always press the **RE-ZERO** button before placing your sample on the weighing pan?
- Do you place your sample in the center of the weighing pan?
- Did you perform a sensitivity adjustment before weighing?
- Did you warm up the balance before weighing for at least an hour, or at least four hours for BA-6TE / BA-6DTE, with the AC adapter connected to the power supply?

Sample and container

- Is the sample free from moisture absorption or evaporation due to the influence of ambient temperature and humidity?
- Is the temperature of the container of the sample acclimatized to the ambient temperature? Refer to "2.4. Precautions during use for more accurate weighing".
- Is the sample free of static electricity? Refer to "2.4. Precautions during use for more accurate weighing".
The sample may be charged with static electricity especially with the BA-6TE/BA-6DTE when the relative humidity is low.
- Is the sample a magnetic material (iron, etc.)? Care must be taken when weighing magnetic materials. Refer to "2.4. Precautions during use for more accurate weighing".

26.2. Asking for repair

If the balance needs service or repair, contact your local A&D dealer. The balance is a precision instrument. Use much care when handling the balance when transporting the balance.

Use the packing material and box that the balance was contained in at the time of purchase.

Remove the weighing pan and pan support from the main unit of the balance.

27. Specifications

27.1. Common specifications

27.1.1. Function

Internal weight	BA-6TE, BA-6DTE BA-225TE, BA-225DTE, BA-125DTE	:approx. 5 g :approx. 100 g	*1
Ionizer (static eliminator)	Detached type		
Sensitivity drift (10 °C to 30 °C)	±2 ppm/°C (Automatic sensitivity adjustment OFF)		
Operating environment	5 °C to 40 °C, 85%RH or less (no condensation)		
Environment sensor	Measurement accuracy: Temperature ±1.5 °C, relative humidity ±10 %, barometric pressure ±10 hPa Applicable temperature range: 5 to 40 °C		
Operation	Touch screen and key switches		
Display	5-inch WVGA TFT LCD color display		
Display refresh rate	5 times/second or 10 times/second		
Counting mode	Number of samples	10 to 100 pcs	
Percent mode	Readability	0.01%, 0.1%, 1% (Automatically changed by 100% reference mass)	
Communication	RS-232C (printer, PLC, etc.), USB type A (USB flash drive, for data storage), USB type B (PC), LAN (TCP/IP), Bluetooth (PC, etc.), *2 Stereo jack (external switch) x 2		
Power (AC adapter)	Confirm that the adapter type is correct for the local voltage and power receptacle type. Power consumption: Approx. 36 VA (including the AC adapter)		

*1 The internal weight may change in mass due to the usage environment and deterioration over time.

*2 Bluetooth® communication capability is disabled for regions where the balance is not certified as being compliant with local laws regarding use of Bluetooth® communication.

27.1.2. Size/Weight

		BA-6TE, BA-6DTE	BA-225TE	BA-225DTE	BA-125DTE
Weighing pan size		φ25	φ85		
Main body weight		6.6 kg	7.1 kg	7.1 kg	7.1 kg
External dimensions	Display unit	182(W) x 138(D) x 73(H) mm			
	Weighing unit and breeze break unit	173(W) x 305(D) x 204(H) mm	173(W) x 305(D) x 284(H) mm		
Ionizer		68(W) x 129(D) x 162(H) mm			

27.2. Individual Specifications

	BA-6TE	BA-6DTE
Capacity	6.2 g	6.2 g
		2.1 g
Maximum display	6.200084 g	6.20008 g
		2.100009 g
Readability	0.001 mg	0.01 mg
		0.001 mg
Repeatability Standard deviation (measuring point)	0.0010 mg (1 g) 0.0030 mg (6 g)	0.01 mg (6 g)
		0.0025 mg (1 g)
Linearity	±0.010 mg	±0.02 mg
		±0.010 mg
Stabilization time FAST setting, good environment	Approx. 10 seconds	Approx. 10 seconds
		Approx. 10 seconds
Counting mode Minimum unit weight	0.1 mg	
Percent mode Minimum 100% reference mass	10.0 mg	
Applicable weights for calibration test/ sensitivity adjustment	Any weight between 1 and 5 g (factory setting: 5 g)	

	BA-225TE	BA-225DTE	BA-125DTE
Capacity	220 g	220 g	120 g
		51 g	51 g
Maximum display	220.00084 g	220.0008 g	120.0008 g
		51.00009 g	51.00009 g
Readability	0.01 mg	0.1 mg	0.1 mg
		0.01 mg	0.01 mg
Repeatability Standard deviation (measuring point)	0.015 mg (50 g) 0.03 mg (200 g)	0.1 mg (200 g)	0.1 mg (100 g)
		0.025 mg (50 g)	0.030 mg (50 g)
Linearity	±0.15 mg	±0.2 mg	±0.2 mg
Stabilization time FAST setting, good environment	Approx. 7 seconds	Approx. 7 seconds	Approx. 7 seconds
		Approx. 7 seconds	Approx. 7 seconds
Counting mode Minimum unit weight	0.1 mg		
Percent mode Minimum 100% reference mass	10.0 mg		
Applicable weights for calibration test/ sensitivity adjustment	Any weight between 10 and 200 g (factory setting: 200 g)		Any weight between 10 and 100 g (factory setting: 100 g)

27.3. External dimensions

(Unit: mm)

		A: Weighing pan diameter	B: Height to the weighing pan	C: Height above the weighing pan
BA-6TE / BA-6DTE	φ25 pan A	φ25	118	47
	Weighing pan for filters	φ50	130	35
BA-225TE / BA-225DTE / BA-125DTE	φ85 pan B	φ85	119	149

Weighing unit/breeze break unit for BA-6TE / BA-6DTE

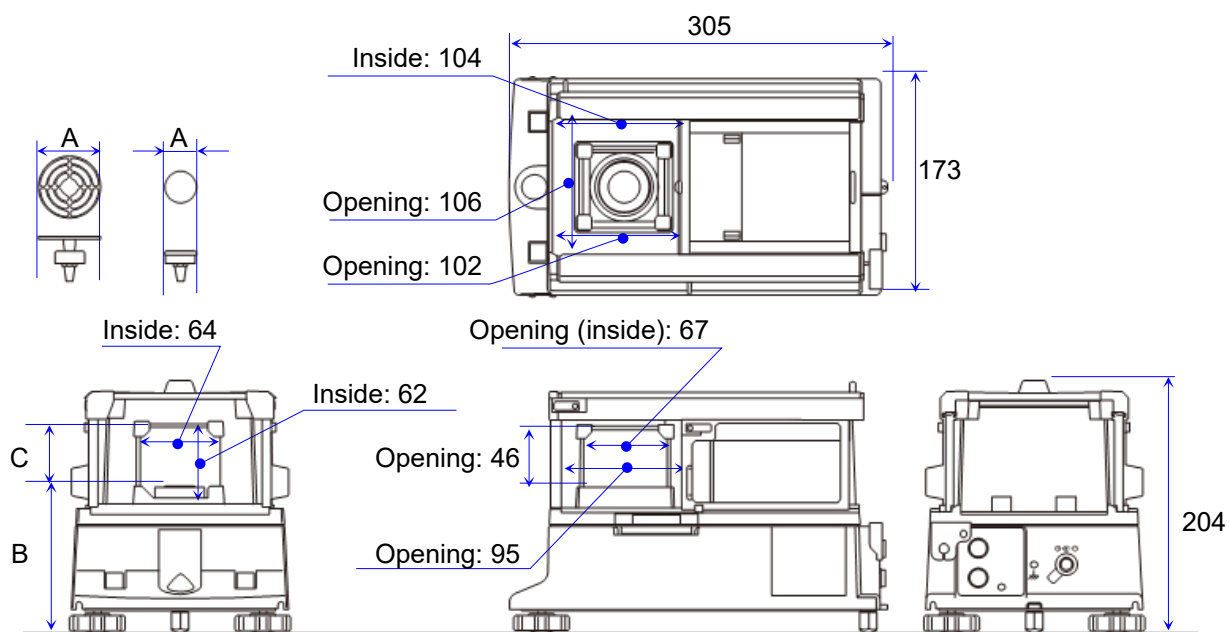

Weighing unit/Breeze break unit for BA-225TE / BA-225DTE / BA-125DTE

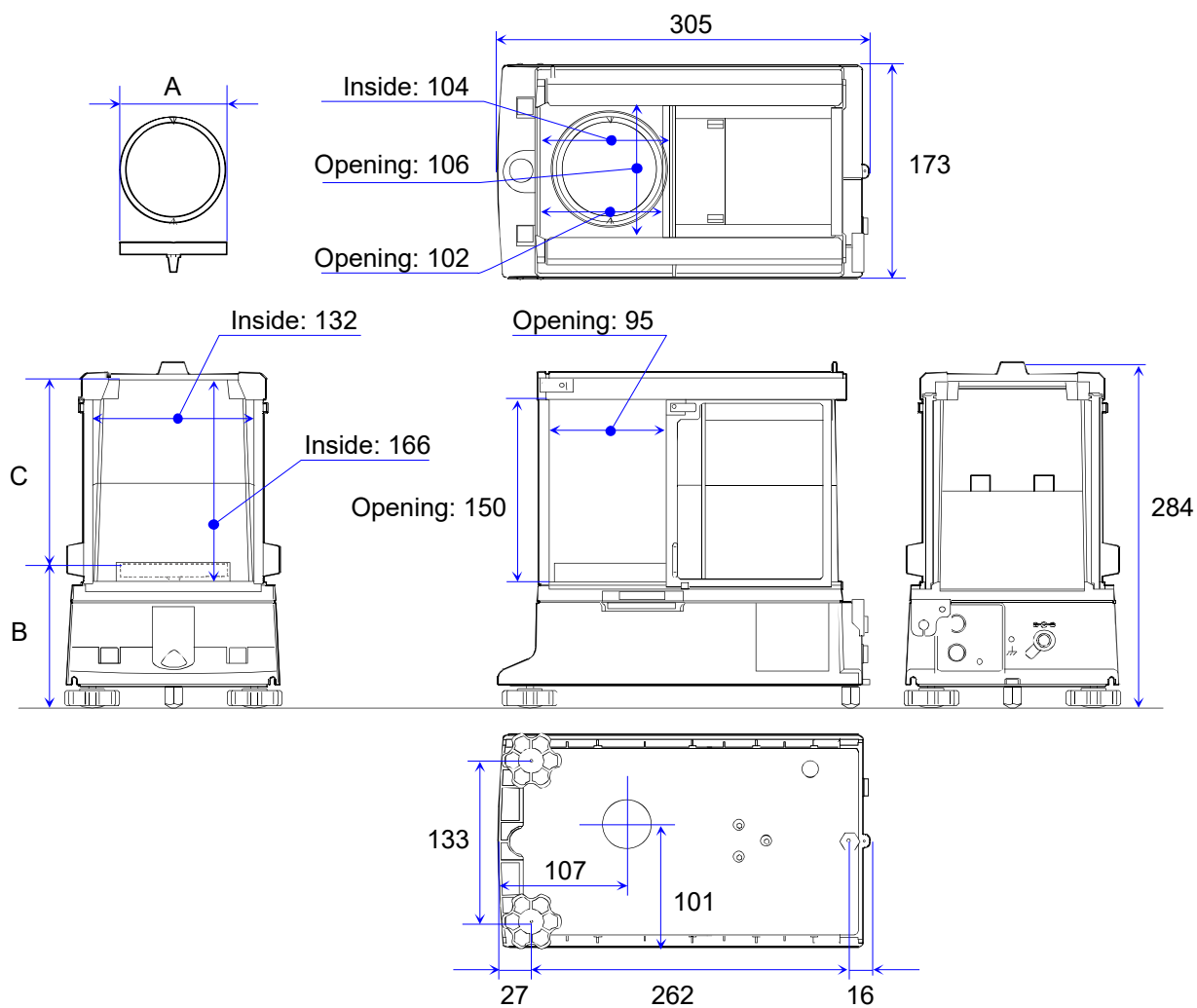

Display unit

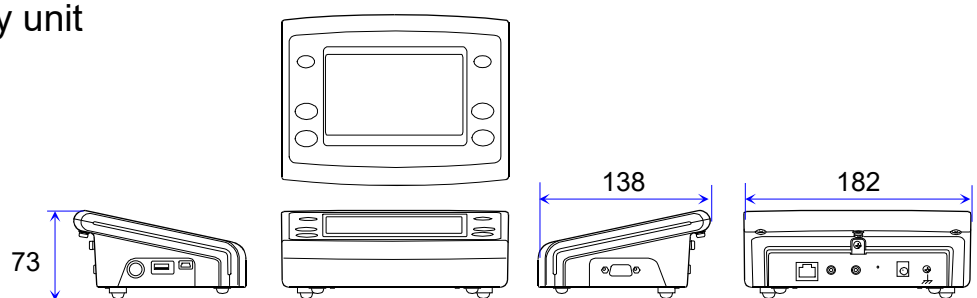

Ionizer

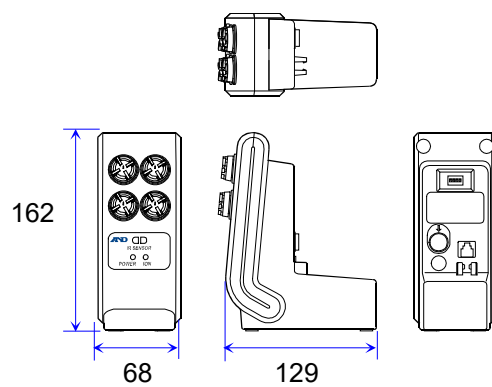

27.4. Peripherals

AD-1671: Anti-vibration table for balances

- This anti-vibration table with a weight of approx. 27 kg and cushioning rubber reduces vibration from the floor and stabilizes the balance's weighing display.

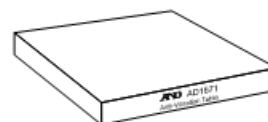

AD-1684A: Electrostatic field meter

- Measures the electrostatic charge of measured objects, or the peripheral equipment such as a container or breeze break for the balance (on automated measuring lines and the like) and displays the measurement result. The charged static electricity can be eliminated by using the ionizer.



AD-1687: Environment logger

- A data logger equipped with four sensors for temperature, humidity, barometric pressure and vibration that can measure and store environmental data
- When connected to the RS-232C interface of the balance, the AD-1687 can store environmental data along with weighing data.

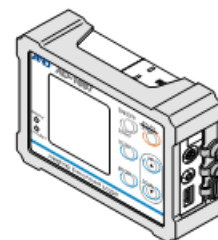

AD-1688: Weighing data logger

- When connected to the RS-232C interface of the balance, the AD-1688 can store the data.
- Convenient for recording data in places where a personal computer cannot be used.



AD-1689: Tweezers for sensitivity adjustment weight

- A pair of tweezers ideally suited for holding sensitivity adjustment weights of 1 g to 500 g.



AD-8922A: Remote controller

- Can be connected to the balance via the RS-232C interface to remotely turn display on/off, adjust sensitivity, output data, switch display, switch unit, re-zero, etc.
- Optional BCD output, comparator output, and analog output are available.

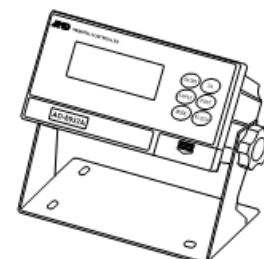

AD-8127: Multi-functional compact printer

- Small dot impact printer that connects with the balance via the RS-232C interface.
- Receives and prints data output from the balance in dump printing mode.



AD-8529PC-W: Bluetooth converter (for a personal computer connection)

- Enables wireless communication between a balance and a personal computer via Bluetooth® up to 10 m.
- Driver installation is required.



AD-8529PR-W: Bluetooth converter (for a printer connection)

- Enables wireless communication between a balance and a printer via Bluetooth® up to 10 m.

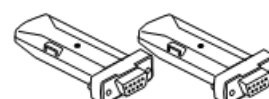

AX-BA-31: Display cover for the BA series (5 pcs)

- Supplied display cover.

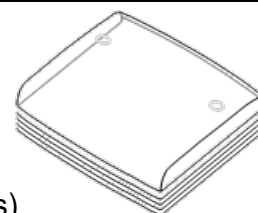

AX-BM-NEEDLESET: Discharge electrode units for the ionizer (a set of 4 pcs)

- Electrode replacement unit for the ionizer.
When replacing, replace the four pieces at the same time.
The instruction manual can be downloaded from our website (<https://www.aandd.jp>).



AX-KO2466-200: RS-232C cable 2m (D-sub 9-pin female - D-sub 9-pin female)

- Cable for connecting the balance and a PLC or the like.

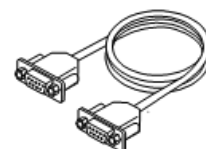

AD-1683A: Ionizer

- Detached type ionizer.
The instruction manual can be downloaded from our website (<https://www.aandd.jp>).



AX-IR-SWITCH: IR switch

- An IR switch to connect to the ionizer.



AX-SW137-PRINT: Foot switch for PRINT (with connector)

- Foot switch for **PRINT** key operations in combination with the BA series.



AX-SW137-REZERO: Foot switch for RE-ZERO (with connector)

- Foot switch for **RE-ZERO** key operations in combination with the BA series.



AX-USB-9P-EX: USB converter

- Converts the RS-232C interface to USB.
- Driver installation is required.

Aluminum analytical pans (100 pcs)

- Sample containers for measuring minute amounts.

Item name	Description	Item code	Shape
Aluminum analytical pans (large)	φ15, 0.8 mL, 100 pcs	AX-ROUND-PAN-L	
Aluminum analytical pans (medium)	φ12, 0.3 mL, 100 pcs	AX-ROUND-PAN-M	
Aluminum analytical pans (small)	φ8, 0.05 mL, 100 pcs	AX-ROUND-PAN-S	

28. Compliance

28.1. Compliance with FCC Rules

This device contains transmitter module FCC ID: RYYEYSHCN

This device complies with Part 15 of the FCC rules. Operation is subject to the following two conditions:

(1) this device may not cause harmful interference, and (2) this device must accept any interference received, including interference that may cause undesired operation.

(FCC = Federal Communications Commission in the U.S.A.)

FCC warning

Changes or modification not expressly approved by the party responsible for compliance could void the user's authority to operate the equipment.

Note: This equipment has been tested and found to comply with the limits for a class A digital device, pursuant to part 15 of the FCC rules. These limits are designed to provide reasonable protection against harmful interference when the equipment is operated in a commercial environment. This equipment generates, uses, and can radiate radio frequency energy and, if not installed and used in accordance with the instruction manual, may cause harmful interference to radio communications. Operation of this equipment in a residential area is likely to cause harmful interference in which case the user will be required to correct the interference at his / her own expense.

28.2. IC

IC RADIATION EXPOSURE STATEMENT FOR CANADA

This device complies with Industry Canada license-exempt RSS standards. Operation is subject to the following two conditions: (1) this device may not cause interference, and (2) this device must accept any interference, including interference that may cause undesired operation of the device.

This device contains transmitter module IC: 4389B-EYSHCN.

28.3. Bluetooth®

The Bluetooth® word mark and logos are registered trademarks owned by Bluetooth SIG, Inc. and any use of such marks by A&D is under license.

Other trademarks and trade names are those of their respective owners.



WolfLabs

Pricing on any accessories shown can be found by keying the part number into the search box on our website.

The specifications listed in this brochure are subject to change by the manufacturer and therefore cannot be guaranteed to be correct. If there are aspects of the specification that must be guaranteed, please provide these to our sales team so that details can be confirmed.

www.wolflabs.co.uk

Tel : 01759 301142

Fax : 01759 301143

sales@wolflabs.co.uk

Please contact us if this literature doesn't answer all your questions.